

<b>CONTENTS (ENGLISH)</b>		<b>Page No</b>
1	CONTENTS MA1.3S USER GUIDE	1
2	APPROVALS	2
3	WARNINGS	2
3.1	EXPLANATION OF GRAPHICAL SYMBOLS	2
3.2	WARNING	2
3.3	CAUTION	2
3.4	IMPORTANT SAFETY INSTRUCTIONS	2
3.5	USER RESPONSIBILITY	3
3.5.1	LOUDSPEAKER DAMAGE	3
3.5.2	LOUDSPEAKER OUTPUT HAZARD	3
3.5.3	RADIO INTERFERENCE	3
4	INTRODUCTION	4
4.1	UNPACKING	4
4.2	FRONT PANEL	4
4.3	REAR PANEL	5
5	REAR PANEL FEATURES	5
5.1	GAIN SWITCH	5
5.1.1	GAIN	6
5.1.2	SENSITIVITY	6
5.1.3	OPTIONS	6
5.2	LINK SWITCH	6
5.3	OPERATING MODES	6
5.3.1	STEREO MODE	6
5.3.2	NOTES FOR AMPLIFIER TESTING	6
5.3.3	TANDEM MODE	7
5.3.4	BRIDGE MONO MODE	7
5.3.5	BRIDGE MONO MODE FEATURES	7
6	INSTALLATION	8
6.1	MOUNTING	8
6.2	COOLING	8
6.3	OPERATING VOLTAGE	8
6.4	DENMARK	9
6.5	GROUNDING	9
6.6	POWER CONSUMPTION	9
6.7	CALCULATION	9
7	CONNECTIONS	10
7.1	INPUT CONNECTIONS	10
7.1.1	BALANCED INPUTS	10
7.1.2	UNBALANCED INPUTS	11
7.2	CONNECTING SPEAKERS	11
8	OPERATION	12
8.1	OPERATING PRECAUTIONS	12
8.2	POWERING UP – SOFT START	12
8.3	INPUT ATTENUATORS	12
8.4	INDICATORS	12
9	PROTECTION FEATURES	13
9.1	OUTPUT LIMITER	13
9.2	THERMAL PROTECTION	13
9.3	VHF PROTECTION	13
9.4	SHORT CIRCUIT PROTECTION	14
9.5	AC MAINS VOLTAGE PROTECTION	14
9.6	DC PROTECTION	14
10	MAINTENANCE	14
10.1	TROUBLESHOOTING	14
11	WARRANTY	15
12	SPECIFICATIONS MA1.3S	16

## 2 APPROVALS



This equipment conforms to the requirements of the EMC directive 89/336/EEC, amended by 92/31/EEC and 93/68/EEC and the requirements of the Low Voltage Directive 73/23/EEC, amended by 93/68/EEC.

Standard Applied

EMC Emission  
EMC Immunity  
Electrical Safety

EN55103-1, E3  
EN55103-2, E3, with S/N below 1% at normal operation level.  
EN60065, Class I

## 3 WARNINGS

### 3.1 Explanation of graphical symbols



The lightning symbol within a triangle is intended to alert the user to the presence of lethal voltages within the amplifier that are of sufficient magnitude to constitute a risk of electric shock to humans.



The exclamation mark within a triangle is intended to alert the user to the presence of important operating and service instructions in the literature accompanying the product.

### 3.2 WARNING

To reduce risk of fire or electric shock, do not expose this apparatus to rain or moisture.



### 3.3 CAUTION

To reduce the risk of fire or electric shock, do not remove screws. There are no user-serviceable parts inside this amplifier. Refer servicing to qualified personnel only.

### 3.4 Important Safety Instructions

Before using your amplifier, please read the operating instructions and the safety suggestions



1. Keep this manual for future reference.
2. Do not operate the amplifier if liquid ingress is suspected.
3. Do not stand water or any other liquid on, or near the amplifier.
4. Do not use this amplifier near water. Do not operate the amplifier if wet or standing in liquid.
5. Clean only with dry cloth.
6. Do not block the air intake or exhaust ports. Always install the unit in accordance with the instructions.
7. Do not operate the amplifier on or near any source of heat, such as radiators, lighting dimmer racks, or other apparatus that produce heat.
8. Always operate the amplifier with the chassis ground wire connected to the electrical safety earth. Do not tamper with the purpose of the electrical safety earth, it is provided for your safety. A grounding type plug is fitted; this has two pins and a third grounding prong. If the plug provided does not fit your mains outlet, consult an electrician or a competent person to replace the fitted plug. See page 10 section 6.3 for wiring colour code
9. Connect only to AC power outlets rated 230 - 240V (or 100 - 120 V), 50-60Hz.
10. Do not use this amplifier if the mains cable is damaged or frayed, particularly check where the mains cable exits the amplifier and the mains plug. Protect the mains cable from being walked upon or rolled over by heavy objects.
11. Only use accessories specified by the manufacturer.



12. The amplifier is intended to use in a 19" rack. Follow the mounting instructions. When racks with wheels are used, use caution to avoid injury from tipping when in motion.
13. Unplug this apparatus during lightning storms or when unused for long periods of time.
14. Do not connect an amplifier output in parallel or series with any other amplifier's output. Do not connect the amplifier output to any other voltage source, such as a battery, mains outlet, or power supply, regardless of whether the amplifier is turned on or off.
15. Do not run the output of any amplifier back into another channel's input.
16. Refer all servicing to qualified personnel only. Servicing is required when the apparatus has been damaged in any way such as:
  - Mains cable, or plug is damaged
  - Liquid has entered the amplifier.
  - An object has fallen into the unit
  - The amplifier has been exposed to rain or moisture
  - The amplifier does not operate normally
  - The amplifier was dropped or the enclosure is damaged
17. Do not remove top or bottom covers. There are no user serviceable parts inside the amplifier, removal of the covers will expose hazardous voltages, and may void the warranty.
18. An experienced person should always supervise inexperienced adults or minors when using professional audio equipment

### 3.5 User responsibility

#### 3.5.1 Loudspeaker damage



Your amplifier is very powerful and can be potentially dangerous to both loudspeakers and humans alike. Many loudspeakers can be easily damaged or destroyed by overpowering, especially with the high power available from a bridged amplifier. Always check the loudspeaker's continuous and peak power capabilities. Even when using the amplifier's front panel attenuator's to reduce the gain, it is still possible to reach full output power, if the input signal level is high enough.

#### 3.5.2 Loudspeaker output hazard



Power amplifiers are capable of producing hazardous output voltages. To avoid the risk of electric shock, do not touch any exposed loudspeaker wiring, when the amplifier is operating. See page 12 Connecting loudspeakers.

#### 3.5.3 Radio interference

A sample of this product has been tested and complies with the limits for the European Electro Magnetic Compatibility (EMC) directive. These limits are designed to provide reasonable protection against harmful interference from electrical equipment. This product uses radio frequency energy and if not used or installed in accordance with these operating instructions, may cause interference to other equipment, such as radio receivers. Compliance with the (EMC) directive does not automatically guarantee non- disturbance of susceptible equipment in close proximity to this amplifier.

If this equipment is suspected of causing interference this can be easily checked by powering the amplifier on and off, the user can correct the interference by one or more of the following measures:

- Re - orientate or relocate the receiver's antenna.
- Increase the distance between the amplifier and the effected equipment
- Connect the mains cable to a socket on a different circuit from that to which the affected equipment is connected.
- Check if the affected equipment complies with the EMC limits for immunity, (CE-labelled). If not, address the problem with the manufacturer or supplier. All electrical products sold in the EC must be approved for immunity against electromagnetic fields, high voltage flashes, and radio interference.
- Consult your dealer or an experienced engineer/ technician for help.

## 4 INTRODUCTION

Thank you for purchasing a Martin Audio power amplifier. This manual contains important information on operating your amplifier correctly and safely. Please take some time to read this manual and familiarize yourself with the advanced features of this amplifier.

### 4.1 Unpacking

Each Martin Audio MA series amplifier is built to the highest standard and thoroughly inspected before it leaves the factory. After unpacking the unit, examine it carefully for any signs of transit damage and inform your dealer if such damage is found. It is suggested that you retain the original packaging so that the unit can be repackaged at a future date if necessary.

Please note that Martin Audio and its distributors cannot accept responsibility for damage to any returned product through the use of non - approved packaging.

### 4.2 Front Panel

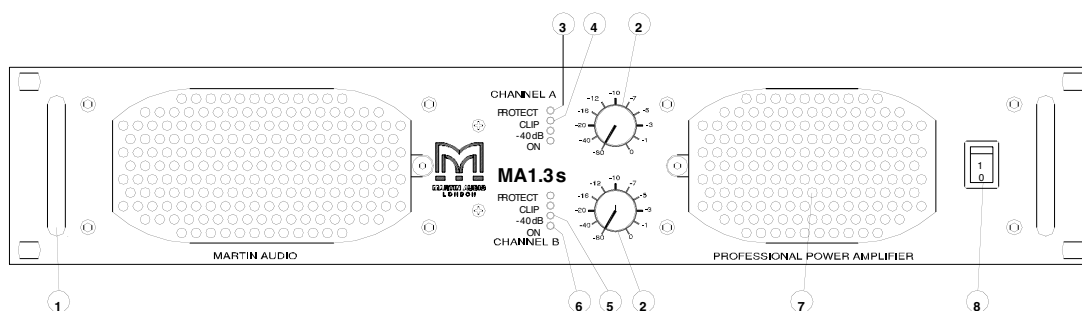

#### 1. Carry/protection handle

Both handles can be used to carry the amplifier; they also act as protection for the front panel. In fixed installations or where rack front covers are too shallow, they may be removed by unscrewing the retaining bolts behind the front panel.

#### 2. Input level attenuators

These controls are used to set the signal level entering the amplifier. They are calibrated in dB's to assist the setup of active loudspeaker systems. (See page [12](#)).

#### 3. Protect indicator LED

This indicator illuminates if the amplifier attempts to function above its maximum operating temperature (90°C). The indicator first comes on as a warning to either turn down the input level or check the cooling arrangements, after which point the amplifier will mute the input signal. When the cooling fans have returned the output heat sinks back to the normal operating temperature the input signal is un-muted.

This indicator also illuminates when signals above 12 kHz at full power are detected at the output terminals, or if the short circuit protection is activated. Should this occur the input signal is muted, and the process repeats until the VHF signal is no longer present. (See page [13](#)).

#### 4. Clip/limit indicator

This indicator signals when the amplifier output is clipping or limiting. It has two different indication states:

If the clip limiter is engaged, it has a short time constant and it illuminates briefly. (See page [13](#)).

If the clip limiter is not engaged, it has an increased time constant and it illuminates for a longer period.

#### 5. Signal present indicator

This LED illuminates at -40dB below full output signal

#### 6. On indicator

The two bottom green LED's indicate that the output circuits are receiving the correct rail voltage.

### 7. Fan grille filters

Two grilles with foam filters are located on the front panel to prevent dust from entering the amplifier. The grilles are removable for easy cleaning of the filters by simply pulling them off. The foam filters should always be used.

### 8. Power switch

Turns mains power on or off.  
(See page [8](#) and [12](#).)

### 4.3 Rear Panel

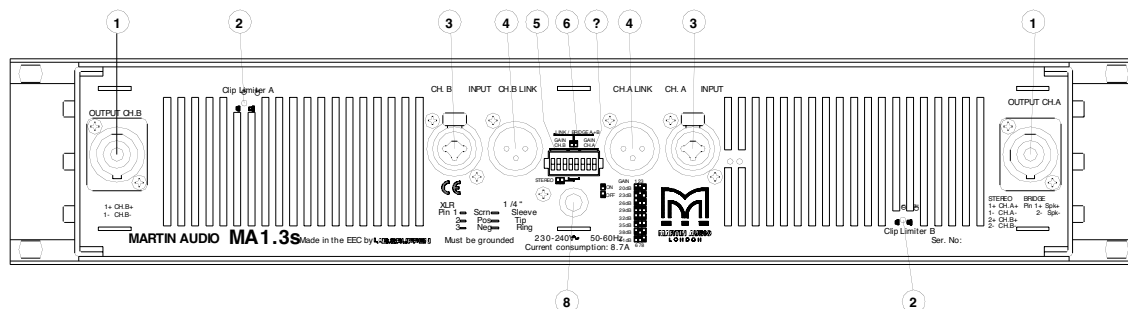

#### 1. Output / Speaker connector

The Speakon connector from Neutrik may be unfamiliar to some users. A full description is found in the operation section. (See page [11](#)).

#### 2. Clip limiter switch

Turns the clip limiter “ON” (switch IN position) or “OFF” (switch OUT position). (See page [13](#)).

3. Input signal XLR. Neutrik Combijack features also \_ TRS phone jacks. (Pin 2 is “hot”, see page [10](#)).

4. Link Input. XLR male connector connected in parallel to the female for linking the channel to another input.

5. Gain switch channel B. Three of the switches in the DIP-switch selects the maximum gain of the channel to be either 20, 23, 26, 29, 32, 36, 39 or 41 dB. (See page [5](#)).

6. Link and Polarity reverse switch. Two of the switches in the DIP-switch are used for Link and Bridge operation. (See page [6](#)).

7. Gain switch channel A. Three of the switches in the DIP-switch selects the maximum gain of the channel to be either 20, 23, 26, 29, 32, 36, 39 or 41 dB. (See page [5](#)).

#### 8. AC Mains cable. WARNING!



A label just below the mains cable on the rear of the amplifier indicates the selected AC mains operating voltage. Connect the mains cable only to the AC source referred to on the label.

## 5 REAR PANEL FEATURES

### 5.1 Gain switch

The gain switch located on the rear panel (the central DIP-switch) changes the gain/input sensitivity of the amplifier. This can be useful when using low or high nominal input signals. Most professional mixing consoles operate at a nominal level of +4 to +6 dBu; the 32dB gain position ensures there is plenty of movement available of the output fader. For semi professional mixing desks operating at a nominal level of 0dB or -10dB the higher gain settings of the amplifier can be used.

The DIP-switch

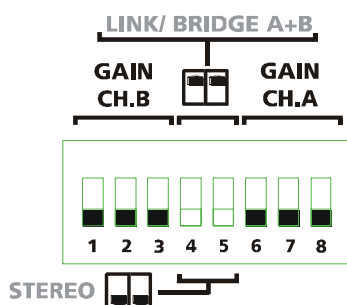

Different gains and function can be selected for channel A and B, by appropriate setting of the DIP switch. Selecting the maximum gain of the amplifier is always a trade off between noise and headroom. A low gain amplifier amplifies less of the noise of the preceding equipment (mixer, crossover, equalizer etc.). A higher input level is then required to attain full power output, so the headroom will be decreased on mixer or crossover processor. In an actively driven system there is usually a dedicated loudspeaker processor or controller, for the loudspeaker system. Most loudspeaker manufacturers recommend a specific gain for the amplifiers for use with their controllers.

### 5.1.1 Gain

There are eight positions of gain selectable, from 20dB to 41dB in 3dB steps. The different settings for the DIP-switches are listed in the table below. The three switches to the very left are for channel B, and the three to the very right are for channel A. The two switches in the middle select the operating mode of the amplifier, Stereo or Link /Bridge A+B.

#### GAIN 123

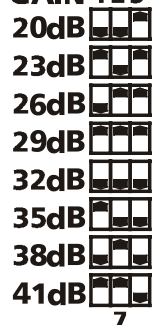

### 5.1.2 Sensitivity



Sensitivity is the level in volts (rms) or dBu (referred to 0.775Vrms) that is required to obtain full output power. As the output power varies with the load impedance, usually 4 ohms is usually taken as the reference.

We recommend calculating the sensitivity if this is necessary.

As a guide the table below gives the input level in volts rms, and dBu, versus gain, for full power output @1% thd 1KHz sine wave.

Gain dB	20	23	26	29	32	35	38	41
Input dBu	+16.7	+13.7	+10.7	+7.7	+4.7	+1.7	-1.3	-4.3
Input V rms	5.30	3.75	2.65	1.88	1.33	0.94	0.67	0.47

### 5.1.3 Options

As the DIP-switch is recessed, a sticker can be placed across the cut out to prevent unauthorized tampering. Another option is to remove the DIP-switch. **This should only be done by authorized service personnel.** This corresponds to all switches set to "OFF", i.e. 32dB gain and stereo mode.

### 5.2 Link switch

The Link switch located on the rear panel (the central DIP-switch) is for changing the operating mode of the amplifier (see below, section 5.3).

### 5.3 Operating modes

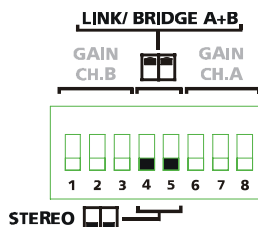

#### 5.3.1 Stereo mode

In this configuration, both channels operate independently of each other. This is used for all 2-channel operations, e.g. bi-amp and stereo. Stereo mode is selected by placing the two central switches in the "OFF" position (Down). The attenuators on the front panel control the respective channels levels.

**Never connect either output terminal to ground or in parallel.** The recommended minimum nominal impedance, for stereo or tandem operation, is 2 ohms per channel.

#### 5.3.2 Notes for amplifier testing

NOTE: Channel B is always polarity reversed on the input, and polarity reversed back on the output. On channel B the positive output voltage with respect to 0V appears on pin -2 of the Speakon connector. Channel A is connected with normal polarity. By having channel A and B operating in opposite polarity, the energy storage in the power supply is more efficient. This is significant for signals below 100 Hz (sub bass etc.) and improves the power

bandwidth. **Be sure to use balanced inputs on all measuring equipment (including oscilloscope probes) if you are bench testing.**

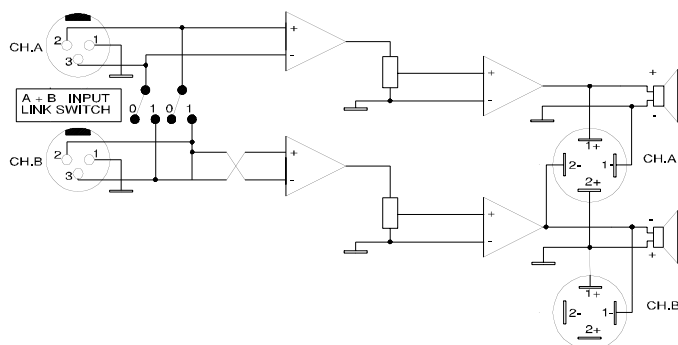

Reverse operation of Channel B.

### 5.3.3 Tandem mode

In tandem mode channel A input is linked to channel B input, either input socket may then be used to provide the input signal. Tandem mode is activated by placing the two central switches (4 and 5) in the “ON” position (UP). Both input attenuator’s are active, allowing you to set different levels for each channel. Note that only the inputs are connected in parallel. This is NOT a parallel output mode. **Never connect either output terminal to ground or in parallel.**

You can use the remaining input connectors to parallel off “Daisy – chain” signals to other amplifiers.

**NOTE: Always turn off the Link switch when using the amplifier for Bi-amping.**

### 5.3.4 Bridge mono mode

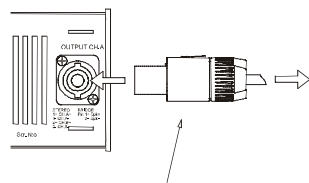

Bridge mono mode is used to deliver increased power to the loudspeakers. Using the MA1.3s in bridge mode reduces the number of channels from two to one. The nominal impedance of the load must be more than 3 ohms. Set the Link/bridge switches to the “ON” position (UP) and use either of the input connectors A or B. You can use the remaining input connectors to carry a parallel signal to other amplifiers. Both A and B level attenuators must be in the same position. We recommend they are used in the 0dB fully clockwise position.

The loudspeaker should now be connected to channel A output Speakon. (+1 should be connected to the [+] terminal of the loudspeaker, and -2 to the [-] terminal of the loudspeaker)

### 5.3.5 Bridge mono mode features

Bridged mono mode combines the power of two output channels into one. This results in twice the voltage swing, four times the peak power and just less than three times the full power of a single channel.

This is because the coil is driven with positive voltage at one pole and an equivalent negative voltage at the other pole. So, if an 8 ohms load is connected in bridged mode, one channel shares one 4 ohms part of the load, and the other channel shares the other 4 ohms part. The power into 4 ohms from an MA 1.3s is 650W. So, the total bridged power into the 8 ohms load will be  $2 \times 650W = 1300W$ .

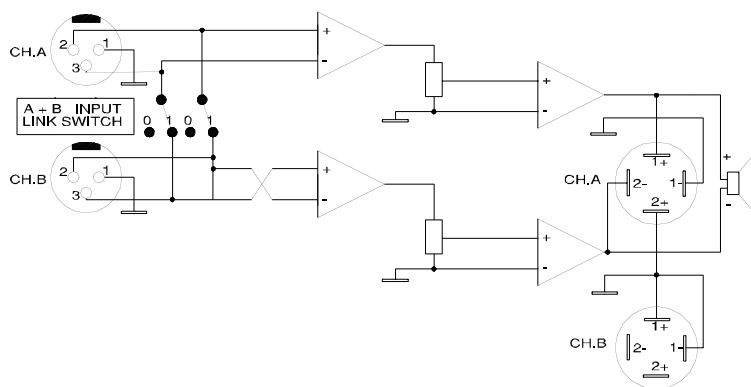

## 6 INSTALLATION

### 6.1 Mounting

The amplifier is two rack units high (2U) and weighs 7.9Kg (17lbs) and will mount in a standard EIA 19" rack. Amplifiers may be stacked directly on top of each other. There is no need for spacing between units. If it is the intention to fill a rack with amplifiers, we recommend racking is started from the bottom of the rack. It is also recommended that rear supports are used for amplifiers mounted in the middle of the rack, especially if used as part of a portable system.

### 6.2 Cooling

Your amplifier uses a forced air cooling system to maintain a low and even operating temperature. All fan cooled MARTIN AUDIO MA series amplifiers have front to rear cooling. Never try to reverse the direction of airflow, as the amplifier needs a pressure chamber between the fans and the internal heat sink and this only operates in one direction of the airflow.

Make sure there is adequate air supply in front of the amplifier, and that the rear of the amplifier has sufficient space to allow the exhaust air to escape. If the amplifier is rack mounted, do not use covers or doors on the front or rear of the rack. If the heat sink temperature rises too high, sensing circuits will mute the hot channel. If the power supply overheats, another sensing circuit will mute both output channels, until they cool down to a safe operating temperature.

For installations with a central cooling system, usually found in fixed installations with a dedicated rack room, it may be necessary to calculate the maximum heat emission. Refer to Power consumption on page 9. Remember never rack different brands of amplifiers together that have opposing air flow characteristics.

### 6.3 Operating voltage

#### WARNING!

**A label just below the mains cable inlet on the rear of the amplifier indicates the selected AC mains operating voltage. Connect the mains cable only to the AC source referred to on the label. The warranty will not cover damage caused by connecting to the wrong type of AC mains.**

If the fitted mains connector is not appropriate for your country, it can be cut off and wired to a suitable connector in the following way:

<b>BLACK or BROWN</b>	<b>LIVE</b>
<b>WHITE or BLUE</b>	<b>NEUTRAL</b>
<b>GREEN or GREEN/YELLOW</b>	<b>EARTH</b>

Once connected to a suitable AC supply, the amplifier can be started with the power switch. When you power up the amplifier it takes a couple of seconds to self check (this is known as the "soft start" or "slow start" sequence),



the fans then blow at high speed before going into "idle". The two bottom green LEDs then illuminate to show the amplifier is operational.

**6.4 Denmark:**

National deviation concerning installation of the MA1.3s:

Danish safety regulation only permits the use of an 8A main fuse. As the MA 1.3s uses an internal primary mains fuse of 15A, the MA1.3s must be equipped with an industrial mains connector rated for 16A or above, or as an alternative it can be hard wired to a 16A capacity circuit and breaker.

**6.5 Grounding**

There is no ground lift switch or terminal on this amplifier. The signal ground is always floating via a resistor to chassis and the grounding system is automatic. If a potential difference above 0.6V is detected between signal ground and chassis ground, a short circuit is automatically introduced between the two, ensuring electrical protection. If other equipment or amplifiers within a system should develop an electrical fault to earth, the mains fuse on that equipment should rupture due to this automatic system, allowing an earth current to flow for protection purposes.

If however you wish to permanently connect the signal ground to chassis earth, connect the XLR-connector's shell lug to pin 1. In the interest of safety never disconnect the earth pin on the mains cable.

To comply with CE approval (radio interference), there is an AC mains filter. This filter needs the chassis ground for reference, otherwise a current loop is formed via the signal ground.

**Never disconnect (lift) the mains safety earth.**

**6.6 Power consumption**

There are three ways to determine the power/current consumption of the amplifier:

**First**, the peak current draw at full output power. Under this condition the power amplifier will operate for less than 2 minutes before thermally limiting or blowing the mains fuse, and is an unrealistic 'normal' use condition. To design a mains distribution system based on the current draw at full power would result in an over specified system. No programme material requires the full steady state continuous power of an amplifier. This operating condition is only used for amplifier bench testing.

**Second**, the maximum expected average current under worst-case program material, which is 1/3 of full power according to the FTC-standard. At this level the music will be in a state of constant clip and is therefore the highest power level that can be obtained without completely obliterating the program material.

**Last**, the "normal operating power", as defined by EN 60065, IEC 65/ANSI/UL 6500 as a measurement level for approval and testing to these standards. The normal operating power is measured using pink noise, with an average output power equal to 1/8 of full power. The one-eighth power is the maximum level music can be re-played without continuous amplifier clipping; this corresponds to headroom of only 9dBs, which is very low for normal program material.

MAX OUTPUT POWER						
			Power [W]	1/3 Power note 1	1/8 Power note 2	Idle
MA1.3s	8 ohms	2x	350	630	400	110
	4 ohms	2x	650	1120	700	110
	2 ohms	2x	1100	1975	1185	110

note 1 Average power with music as program source. The amplifier driven to clip level.  
note 2 Normal music power with 9dB headroom, IEC standard power rating.

**6.7 Calculation**

The current draw can be calculated by dividing the mains input power by the mains voltage.

We recommend you to design the power distribution for at least the current at 1/8 power, and 1/3 power for heavy-duty demands such as concert touring and industrial music etc.

The heat power can be calculated as follows:

If a headroom figure of at least 5dB (1/3 of full power) is used with a 4 ohms load on each output of the amplifier.

The 1/3 power per channel is then;  $650 / 3 = 217$ watts, and the total output power =  $2 \times 217 = 433$  watts.

The power consumption according to the chart above is then 1330watts.

The heat power produced is the difference between the power consumption and output power;

$1120 - 433 = 687$  watts total for the amplifier.

MA1.3s HEAT POWER						
	1/3 POWER	1/8 POWER	1/3 POWER	1/8 POWER	1/3 POWER	1/8 POWER
	WATTS		Kcal/hour		BTU/hour	
8 Ohm	397	313	340	270	1350	1070
4 Ohm	687	538	590	460	2340	1840
2 Ohm	1242	910	1070	780	4240	3110

1/3 Power level = Average power with music as programme source. The amplifier driven to clip level  
 1/8 Power level = Normal operating power with music as programme source, 9dB headroom

## 7 CONNECTIONS

### 7.1 Input connections

#### 7.1.1 Balanced inputs

XLR Input connectors are active balanced and wired according to the IEC 268, that is pin 2 hot, and wired in the following way:

PIN 1            GROUND/SHIELD  
 PIN 2            HOT (+)  
 PIN 3            COLD (-)

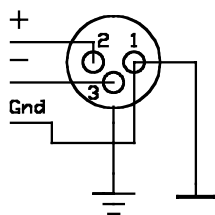

XLR input connector

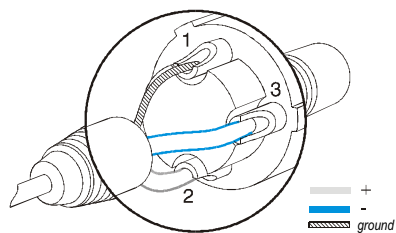

XLR balanced

Within the Neutrik Combojack there is a 1/4(6.3mm) phone jack, which is wired in parallel with the XLR.

TIP                HOT  
 RING              COLD  
 SLEEVE           SHIELD/GROUND

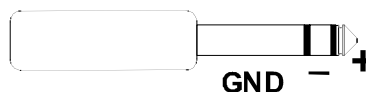

1/4 TRS plug

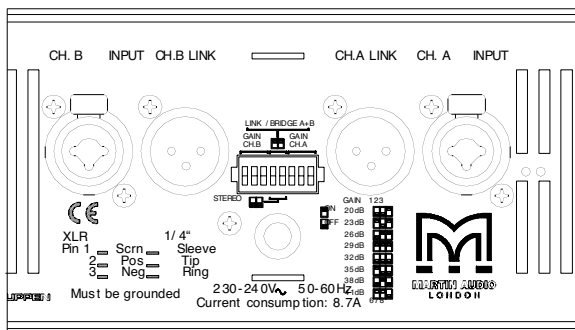

The input impedance is high enough (20k ohms balanced) to allow "daisy-chaining", or multiple parallel input connections. The headroom of the input circuits will also accept the maximum output level from virtually any low-level signal source. Balanced signals are less sensitive to AC hum and radio interference. The source impedance should be less than 1k ohms to avoid high frequency losses if long cable runs are used.

**To daisy chain amplifiers**, use the XLR-male connector, labeled **Link**, provided on each channel. It is connected in parallel with the Neutrik Combo jack on each input.

### 7.1.2 Unbalanced inputs

To connect an unbalanced source, tie pin 3 (ring on TRS jack) down to the shield of the connector. If you leave one pin disconnected, you will lose 6 dB.

A better method for using unbalanced sources is shown in Figure 8. This is similar to the connection for balanced lines, but pin 3 is connected to the shield at the source. The hum and noise rejection for the cable is equivalent to that for a balanced line. To minimize hum in the audio, use balanced inputs whenever possible.

*Unbalanced line connection*

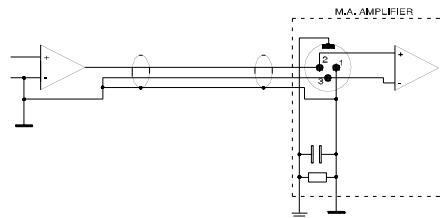
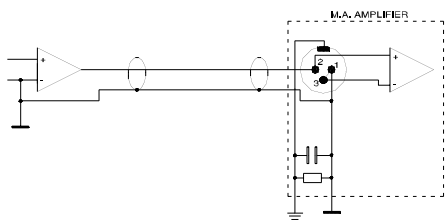

*Balanced line with unbalanced equipment*

For two-channel (stereo) operation, use both channels A and B. For tandem stereo or bridged mono operation, use only one of the inputs. See [operating modes](#) for more details.

## 7.2 Connecting speakers

Speaker connections are made via the two Neutrik NL4FC Speakon connectors. The Speakon connector is designed for high power loudspeaker use and meets all worldwide safety requirements.

Connections:

The Speakons are wired:

Channel A  
 Pin +1, Pin - 1 = Output A  
 Pin +2, Pin - 2 = Output B

Channel B  
 Pin +1, Pin -1= Output B

The right Speakon, Channel A, has both channel A and B outputs available, so is useful for bridging and bi-amp operation (see bridged mono operation on page [7](#)). The left Speakon, Channel B, carries only the channel B output.

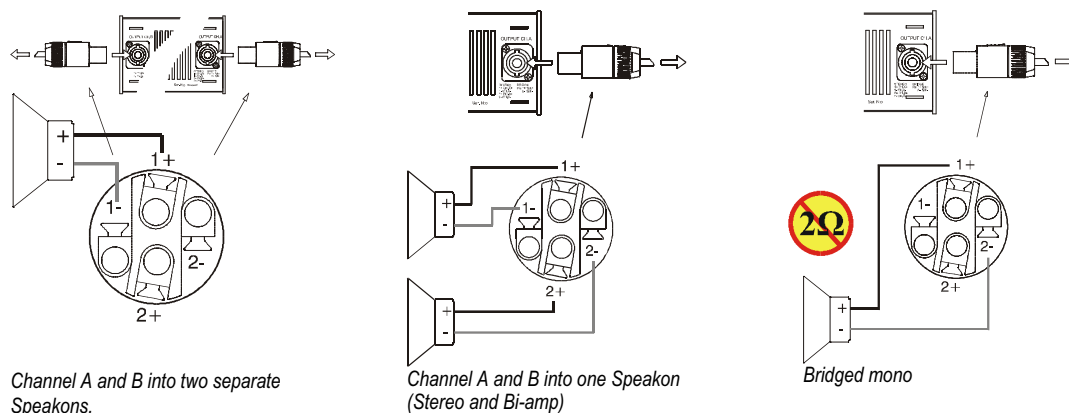

**Never connect either output terminal to ground or to some other output or input terminal (see warnings in chapter 1)**

For normal two-channel operation, connect each speaker load across the output's positive and negative terminals.

**Pay attention to speaker polarity; loudspeakers connected out of polarity degrade sound quality.**

Keep the loudspeaker cables as short as possible and use a good quality stranded cable. Do not use shielded wire, such as microphone or guitar cable. The loudspeaker cable reduces the power of the amplifiers in two ways: It increases the load impedance and introduces resistive power losses.



**WARNING: To prevent electric shock, do not operate the amplifier with any of the loudspeaker cable conductors exposed.**

## 8 OPERATION

### 8.1 Operating precautions

- Make sure that the power switch is set to "OFF" before connecting any input or output or operating the switches on rear panel. See pages [8](#) about installation.
- Make sure that the AC mains voltage is correct and the same as the one printed on the rear panel of the amplifier. See pages [8](#), about operating voltage and power consumption.
- Make sure that the operating mode switches on the rear panel, gain, link/ bridge, and clip-limiters, are in the correct position. See page [6](#) about operating modes, page [13](#) about clip limiters and [7](#) for the ML
- It is always a good idea to turn down the gain controls during power-up, to prevent speaker damage in case a high signal is present at the input.

### 8.2 Powering up – Soft start

When you power up the amplifier it takes a couple of seconds to check its circuits. This is known as the "soft-start" or "slow-start" sequence. The fans then blow at high speed before going into "idle" and the two bottom green LED's illuminate to show the amplifier is operational.

### 8.3 Input attenuators

The two input level attenuators on the front panel adjust the signal level for their respective amplifier channel in all modes. They are calibrated in dB to help the setting up of active loudspeaker systems.

In bridged mode, both controls must be in the same position, so that the speaker load will be shared equally between the channels.

### 8.4 Indicators

The two-bottom green "ON" LED's indicating that the output circuits are receiving the correct rail voltage.

The "-40 dB" LED's illuminate if the output signal is greater than -40dB (with 0dB as reference to full output power). These LED's also act as signal present indicators.

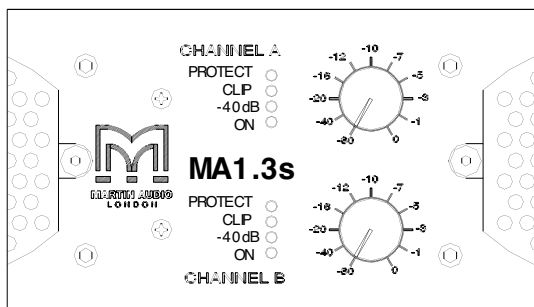

Front Indicators

The **Clip/limit indicator** tells when the amplifier output is clipping or limiting. It has two different indication statuses:

- If the clip limiter is engaged it has a short time constant and it illuminates briefly.
- If the clip limiter is not engaged it has an increased time constant and illuminates for a longer period.

The remaining yellow LEDs indicate if any protection circuits are activated. These are described on page [15](#).

## 9 PROTECTION FEATURES

Each Martin Audio amplifier has many advanced protection features, protecting both the amplifier and the loudspeakers connected to it, should a fault condition arise. Under normal use these features are inaudible. All protection circuits operate independently.

### 9.1 Output Limiter

An output limiter is included to avoid amplifier clipping. When an amplifier is severely overdriven, its output waveform is clipped (its peaks are squared off) – reducing the crest factor. In extreme cases, the waveform can approach that of a square wave. An amplifier is normally capable of producing far more power under these conditions than its normal undistorted rated output power.

The limiter works by monitoring the output and comparing the distortion produced between the input and output of the amplifier. If the distortion exceeds 1%THD for any reason (voltage or current clipping), the limiter reduces the input signal proportionally. Note that, if the signal is distorted or clipped before it reaches the amplifier, the clip limiter will not be activated.

Under normal operation the clip limiter is inaudible. The limiter can be turned “ON” or “OFF” by pressing the relevant clip limit switch. See page 5

Some manufacturers of loudspeaker processors do not recommend the use of clip limiters in amplifiers, as it can affect the tracking of the processor's limiters.

If the amplifier is being used without any external limiting, Martin Audio recommend leaving the clip limiters switched “ON” (button depressed).

### 9.2 Thermal protection

When the amplifier is driven very hard into a low impedance load, the cooling fans will run at high speed. If these operating conditions continue, the Protect indicator(s) will illuminate indicating that the amplifier is about to go into thermal shutdown.

After five seconds the amplifier will go into thermal protect by muting the input signal. After 15-20 seconds the amplifier will have cooled down enough for the amplifier to come out of shutdown and operate as normal. If the load conditions remain unchanged the thermal protection will be re - initiated. Thermal protection occurs when the heat sink temperature reaches 90° C.

### 9.3 VHF protection

If a signal of more than 12kHz, at full power is detected for more than five seconds, the VHF protection mutes the input signal. (This is indicated on the front panel (4) by the LED labeled Protect). After five seconds the outputs will un-mute and return to normal operation, unless the output signal has remained unchanged, in which case the VHF protection will re-initiate.

#### 9.4 Short circuit protection

All Martin Audio MA Series amplifiers are completely short circuit protected. The protection circuit permits very high peak currents, but still holds the output devices within the safe operating area. If a short circuit is maintained, the channel affected will eventually go into a thermal protect cycle until the short circuit has been removed.

#### 9.5 AC mains voltage protection

If the AC mains voltage is outside the operational window (over or under voltage), the power supply will automatically shut down. When the mains voltage is above the minimum start voltage and below its maximum operating voltage the amplifier will restart.

The two green 'ON' LED's indicate when the power supply is operating correctly.

It takes a couple of seconds to self-check (this is known as the "soft start" or "slow start" sequence), the gain will slowly and gradually be increased back to the previously set level, and the fans will blow at high speed before going into "idle".

#### 9.6 DC protection

There are two types of DC protection:

- Fuses on the supply branches of each channel.
- DC crowbar protection that shorts the output if more than 10 volts DC is being detected on the outputs. Both these circuits come into effect once a DC level has been detected on either channel.

## 10 MAINTENANCE

---

Under normal use the amplifier should provide years of trouble-free service. The only maintenance required by the user is to clean the front grill periodically.

In some extreme cases it may be necessary for authorized service personnel to clean the inside of the amplifier.

These conditions usually occur after prolonged use, e.g. in environments using "cracked-oil" smoke machines.

If you are using your amplifier for heavy duty use i.e. concert touring or industrial music it is recommended that you have your amplifier serviced every 3 years, purely as a preventative measure.

#### 10.1 Troubleshooting

These are typical things to check if you think your amplifier is faulty:

**Fault: No output.**

If the signal present LED (-40dB) is illuminating a signal is entering the amplifier; and the likely cause is an unsecured Speakon connector, or loose termination

Check also that the VHF protection is not activated. If it is, remove the cause of the high frequency oscillations from the relevant input.

**Fault: The amplifier goes into thermal protection when driven at low level.**

Check that there is no short circuit present at the amplifier's output, e.g. any component in the loudspeaker (this can occur when the loudspeaker voice coil gets hot).

**Fault: The amplifier goes into protection with power indicators off.**

Check that the AC mains voltage is within the amplifier's operating range, 130-270V and (65-135V @ 115V). Over/under-voltage protection may have occurred. If the amplifier is connected by mistake to a 3-phase supply (415V), an internal non-resettable fuse or resistor may have blown. The amplifier must then be returned to your supplier for service/ repair.

**Fault: The amplifier does not respond even after checking above items.**

In the unlikely event of on a non-user rectifiable fault, return the amplifier to your supplier or an approved service centre.

**Martin Audio cannot be held responsible for damage or injury as a result of the top cover being removed.**

## 11 WARRANTY

---

### General

The MA 1.3s Power amplifier is warranted to be free from defects in components and factory workmanship under normal use and service, for a period of three years from the date of original purchase. During this warranty period MARTIN AUDIO LTD or its nominated agents, will undertake to repair, or at its discretion, replace this product at no charge to its owner, when failing to perform as specified, providing the unit is returned undamaged, in its original packaging, shipping prepaid, to the factory, distributor or authorised service facility.

This warranty shall be null and void, if the product is subjected to:

- 1) Repair work or alteration by persons other than those authorised by MARTIN AUDIO LTD or its agents
- 2) Shipping accidents, act of god, war, civil insurrection, misuse, abuse, operation with incorrect AC voltage, operation with faulty associated equipment, exposure to inclement weather conditions and normal wear and tear. Units on which the serial number has been removed or defaced will not be eligible for warranty service.
- 3) MARTIN AUDIO LTD shall not be responsible for any incidental or consequential damages, with respect to the products warranted

MARTIN AUDIO LTD reserve the right to make changes or improvements in design or manufacturing, without assuming any obligation to change or improve products previously manufactured

This warranty is exclusive and no other warranty is expressed or implied.

This warranty does not affect your statutory rights

### International

Please contact your supplier for this information, as rights and disclaimers may vary from country to country.

### Technical assistance and services

#### International

If your Martin Audio product needs repair, contact your Martin Audio dealer or distributor, or contact martin Audio by fax or email to obtain the location of the nearest authorized service facility.

TELEPHONE: + 44 (0) 1494 535312

FAX: + 44 (0) 1494 438669

E-mail: [info@martin-audio.com](mailto:info@martin-audio.com)

[www.martin-audio.com](http://www.martin-audio.com)

## 12 SPECIFICATIONS MA1.3S

MAXIMUM OUTPUT POWER	EIA @1kHz 1% thd	FTC 20 – 20kHz @ 0.1% thd
8Ω per Channel	350W	340W
4Ω per Channel	650W	630W
2Ω per Channel	1100W	1050W
8Ω Bridged	1400W	1300W
4Ω Bridged	2200W	1900W

### MAXIMUM OUTPUT VOLTAGE

8Ω load 53Vrms  
Peak voltage, no load 78Vrms

### POWER REQUIREMENTS

	<b>230V version</b>	<b>115V version</b>
Operating voltage	130 – 270 Vac	65 – 135Vac
Minimum start up voltage	175Vac	85Vac
Peak inrush current	5A	5A

### MAINS CURRENT DRAW @ 4 Ohms

	<b>230V version</b>	<b>115V version</b>
Quiescent current (no load)	0.9 Arms	1.8 Arms
1/8 <sup>th</sup> Full power (both channels driven)	5.0 Arms	10 Arms
1/3 <sup>rd</sup> Full power (both channels driven)	8.0 Arms	16 Arms
Full power (1Khz @1% thd)	14.0Arms	28.0 Arms

### DISTORTION

THD 20Hz – 20KHz 1W to full power 0.07%  
THD @ 1KHz 1dB below clip 0.01%  
DIM 30 @ 3dB below clip 0.008%

**HUM / NOISE** < -105dB

**CHANNEL SEPERATION** -70dB

**OUTPUT IMPEDANCE** 30mΩ

**SLEW RATE** 40VμS

### INPUTS

DIP switch selectable gain Ref  
4Ω for full power

Gain dB	20	23	26	29	32	35	38	41
Input dBu	+16.7	+13.7	+10.7	+7.7	+4.7	+1.7	-1.3	-4.3
Input V rms	5.30	3.75	2.65	1.88	1.33	0.94	0.67	0.47

Impedance 20KΩ Differential  
10KΩ Single ended

c.m.r.r. 50dB

### DIMENSIONS

(W) 483mm x (H) 88mm x (D) 325mm (incl. Handles)  
(W) 19ins x (H) 3.5ins x (D) 12.8ins (incl. Handles)

### WEIGHT

7.9Kg (17lbs)



**SHIPPING DIMENSIONS**

(W) 560mm x (H) 180mm x (D) 500mm  
 (W) 22ins x (H) 7.1ins x (D) 19.7ins

**SHIPPING WEIGHT**

9.6Kg (21.2lbs)

**Front Panel**

Gain controls  
 Indicators Protect  
 Indicators Clip  
 Indicators Signal Present

2 x 31 Position detent  
 2 x Yellow LED's  
 2 x Red LED's  
 2 x Green LED's

**Rear Panel**

Input Connectors  
 Output Connectors  
 Clip Limiters

2 x Neutrik Combo, + 3 pin Phoenix  
 2 x Neutrik Speakons  
 Push Switch "ON"/ "OFF" per Channel

Speakon<sup>®</sup> and Comb<sup>®</sup> jack, are registered Trademarks of Neutrik AG Liechtenstein.

MLS<sup>®</sup> are registered Trademarks of Lab Gruppen AB Kungsbacka Sweden.

# MA1.3s Amplifier

 Please Click here to  
return to main menu

 Please Click here to  
visit our website



**The Martin Experience**

Century Point, Halifax Road, Cressex Business Park, High Wycombe, Buckinghamshire HP12 3SL, England.

Telephone: +44 (0)1494 535312 Facsimile: +44 (0)1494 438669

Web: [www.martin-audio.com](http://www.martin-audio.com) E-mail: [info@martin-audio.com](mailto:info@martin-audio.com)

All material © 2007. Martin Audio Ltd. Subject to change without notice.

# MA1.3s Amplifier

## User's Guide



**ENGLISH**



**The Martin Experience**