

MA6.8Q & MA4.8Q

User's Guide



The Martin Experience

Q SERIES OPERATION MANUAL

1. CONTENTS

2. Approvals	3
3. Warnings	4
3.1 Explanation of graphical symbols	4
3.2 Important Safety Instructions	4
3.3 User responsibility	5
4. Welcome	7
4.1 Introduction	7
4.2 Main Features	7
5. Installation	10
5.1 Unpacking	10
5.2 Mounting	10
5.3 Cooling	10
5.4 Operating voltage	11
5.5 Grounding	11
6. Quick Guide Overview	12
6.1 front Panel overview	12
6.2 Rear Panel overview	13
6.3 NomadLink / Ethernet network setup	14
7. Operation and Performance	15
7.1 Introduction	15
7.2 Operation precautions	15
7.3 Signal flow and headroom	15
7.4 Audio Input and Output connections, setup and features	17
7.5 Protection, faults and warnings	20
7.6 Front panel monitoring and adjustments	22

7.7 NomadLink network and PC editor.....	24
8. APPENDIX	27
8.1 Maintenance	27
8.2 FAQ	27
8.3 Bench test the amplifier	28
8.4 Additional documentation	28
8.5 BTU specifications.....	28
9. TECHNICAL SPECIFICATIONS.....	30
10. WARRANTY.....	32

2. APPROVALS



This equipment conforms to the requirements of the EMC directive 89/336/EEC, amended by 92/31/EEC and 93/68/EEC and the requirements of the Low Voltage Directive 73/23/EEC, amended by 93/68/EEC.

Standards applied: EMC Emission EN55103-1, E3
EMC Immunity EN55103-2, E3, with S/N below 1% at normal operation level.
Electrical Safety EN60065, Class I



This equipment is tested and approved according to the U.S. safety standard ANSI/ UL 60065 and Canadian safety standard CSA C22.2 NO. 60065. ETL made the tests and they are a Nationally Recognized Testing Laboratory (NRTL).

NOTE:

This equipment has been tested and found to comply with the limits for a Class A digital device, pursuant to part 15 of the FCC Rules. These limits are designed to provide reasonable protection against harmful interference when the equipment is operated in a commercial environment. This equipment generates, uses, and can radiate radio frequency energy and, if not installed and used in accordance with the instruction manual, may cause harmful interference to radio communications. Operation of this equipment in a residential area is likely to cause harmful interference in which case the user will be required to correct the interference at his own expense.

3. WARNINGS

3.1 EXPLANATION OF GRAPHICAL SYMBOLS



The lightning symbol within a triangle is intended to alert the user to the presence of un-insulated “dangerous voltage” within the amplifier’s enclosure that may be of sufficient magnitude to constitute a risk of electric shock to humans.

The exclamation point within a triangle is intended to alert the user to presence of important operating and service instructions in the literature accompanying the product.

3.1.1 WARNING



To reduce risk of fire or electric shock, do not expose this apparatus to rain or moisture.

3.1.2 CAUTION



To reduce the risk of fire or electric shock, do not remove screws. No user-serviceable parts inside. Refer servicing to qualified service personnel

3.2 IMPORTANT SAFETY INSTRUCTIONS

Before using your amplifier, be sure to carefully read the applicable items of these operating instructions and the safety suggestions



1. Keep this manual for future reference.
2. Heed all warnings.
3. Follow all instructions.
4. Do not use this unit near water.
5. Do not spill water or other liquids into or on the unit. Do not operate the amplifier while wet or standing in liquid.
6. Clean only with dry cloth.
7. Do not block the air intake or exhaust ports. Install the unit in accordance with the instructions.
8. Do not operate the amplifier near heat producing devices such as radiators, heat registers, stoves or other apparatus that produce heat. Always operate the unit with the chassis ground wire connected to the electrical safety earth. Do not defeat the safety purpose of a grounding-type plug. A grounding type plug has two pins and a third grounding prong. The third prong is provided for your safety. If the provided plug does not fit into your outlet, consult an electrician for replacement of the obsolete outlet.
9. Connect only to AC power outlets rated 100-120 V or 200-240 V, 50-60 Hz.
10. Do not use this amplifier if the power cord is broken or frayed. Protect the power cord from being walked upon or pinched particularly at the plugs and the point where it exits from the apparatus.
11. Only use accessories specified by the manufacturer.

12. The unit is intended to use in a 19" rack. Follow the mounting instructions. When a rack on wheels is used, use caution when moving the loaded rack to avoid injury from tipping over.
13. Unplug this apparatus during lightning storms or when unused for long periods of time.
14. Do not connect an amplifier output in parallel or series with any other amplifier's output. Do not connect the amplifier output to any other voltage source, such as battery, mains source, or power supply, regardless of whether the amplifier is turned on or off.
15. Do not run the output of any amplifier back into another channel's input.
16. Refer all servicing to qualified service personnel. Servicing is required when the apparatus has been damaged in any way such as:
 - Power-supply cord or plug is damaged.
 - Liquid has been spilled into the unit
 - An object has fallen into the unit
 - The unit has been exposed to rain or moisture
 - The unit does not operate normally
 - The unit was dropped or the enclosure is damaged
17. Do not remove top or bottom covers. Removal of the covers will expose hazardous voltages. There are no user serviceable parts inside and removal may void the warranty.
18. An experienced user shall always supervise this professional audio equipment, especially if inexperienced adults or minors are using the equipment.
19. The mains plug is used as the disconnect device and shall remain readily operable. If mounted in a 19" rack causing the mains plug not being readily operable, the mains plug for the entire rack must be readily operable.
20. The US National Differences cl.16.3 requires that NomadLink network cables must be flame rated VW-1.

3.3 USER RESPONSIBILITY

3.3.1 MAINS CONNECTION GROUNDING



Your amplifier must be connected to a grounded socket outlet.

3.3.2 SPEAKER OUTPUT HAZARD



Power amplifiers are capable of producing hazardous output voltages. To avoid electrical shock, do not touch any exposed speaker wiring while the amplifier is operating. The external wiring connected to the speaker terminals shall be installed by a qualified instructed person or ready-made leads or cords of appropriate capacity shall be used.

3.3.3 RADIO INTERFERENCE



As the amplifier outputs produce high voltage, do not connect or disconnect speaker cables when the mains power is on. Also, attach the safety cover on the speaker terminals for safe operation and to comply with electrical product approvals. A sample of this product has been tested and complies with the limits for the European Electro Magnetic Compatibility (EMC) directive. This equipment has also been tested and found to comply with the limits for a Class B digital device, pursuant to Part 15 of the FCC Rules. These limits are designed to provide reasonable protection against harmful interference from electrical equipment. This product uses radio frequency energy and if not used or installed in accordance with these operating instructions, may cause interference to other equipment, such as radio receivers. However, there is no guarantee that interference will not occur in a particular installation. If this equipment does cause harmful interference to radio or

television reception, which can be determined by turning the equipment on and off, the user is encouraged to try to correct the interference by one or more of the following measures:

- Reorient or relocate the antenna.
- Increase the separation between the equipment and receiver.
- Connect the equipment into an outlet on a circuit different from that to which the receiver is connected.

3.3.4 SPEAKER DAMAGE



Your amplifier is very powerful and can be potentially dangerous to both loudspeakers and humans alike. Many loudspeakers can be easily damaged or destroyed by overpowering, especially with the high power available from a bridged amplifier.

Always check the speaker's continuous and peak power capabilities.

Even though the amplifier's front panel attenuators can be used to reduce the gain, it is still possible to reach full output power if the input signal level is high enough.

3.3.5 MAINTENANCE

For long-term and safe operation it is recommended that the amplifier dust filters on the front panel, as well as the inside of the amplifier is cleaned regularly. If the dust filters and inside are not maintained there will be safety risks. For example the amplifier can ignite the dust and a fire will occur due to high internal temperatures. There is also a risk that the amplifier will malfunction since the amplifier is dependent of constant airflow from front to rear. If the dust filters are not clean and the amplifier malfunctions, any resultant problems will not be covered by the warranty.

4. WELCOME

4.1 INTRODUCTION

Thank you for choosing Martin Audio Q Series power amplifiers for your sound reinforcement system installation. We are confident that you will be very pleased with the performance, configuration flexibility, reliability, and long-term durability offered by the Q Series products.

This manual provides a comprehensive guide to the features and functionality of Q Series amplifiers. Please read through it in its entirety to become fully acquainted with the many configuration options and multiple layers of protection circuitry.

To facilitate timely installation and use of this Q Series product, we have included a Quick Guide Overview (section 6). This brief summary, in conjunction with Installation (section 5), contains the basic information needed to safely install the amplifier and place it in service. However, we highly recommend reading through this manual in its entirety, beginning with Main Features and Technologies and continuing through Operation and Performance. As you become thoroughly familiar with all aspects of operation, you may learn of features or options that will affect your choices on amplifier modes or loudspeaker system configuration.

Thank you again for placing your confidence in Martin Audio power amplifiers.

Martin Audio Q Series power amplifiers are designed and built specifically for the unique demands of permanent installation applications. Q Series amplifiers offer the optimum combination of high quality audio reproduction, flexible features, ease of installation, and 100% reliability in normal use.

By packing four channels of reconfigurable power amplification into a 2U chassis, the Q Series achieves unprecedented "power density." The benefits of compact dimensions include reduced rack space requirements and minimal heat build-up. The flexible output stages enable each amplifier channel to be set for either low impedance or constant voltage (70 V /100 V) mode. NomadLink, an easy-to-use network for monitoring and control, is implemented as a standard feature on all Q Series amplifiers.

Although Q Series features and facilities are tailored to installation applications, at the heart of each amplifier is the same advanced technology that has made Martin Audio the benchmark of quality for touring concert systems: exceptional sonic performance, rugged construction, proven reliability, and protection features that anticipate every unwelcome possibility.

Read on to learn.

4.2 MAIN FEATURES

Superficially, your new Q Series amplifier may appear similar to other products made for the same purpose. On closer inspection, however, you will find a number of sophisticated technologies – many proprietary to the manufacturer – that are provided to ensure the best possible performance and many years of reliable operation. Familiarizing yourself with these technologies will prove invaluable in setting up and optimizing your loudspeaker system.

4.2.1 CLASS TD AMPLIFIER AND REGULATED SWITCH-MODE POWER SUPPLY

The patented Class TD technology combines the exceptional efficiency of a Class D amplifier with the high sonic quality associated with Class B designs. Class TD also incorporates the same basic

concepts behind Class H designs, but here they are refined and pushed to a higher level to achieve much greater efficiency.

The Class TD output sections work in concert with the unique regulated switch-mode power supply to create a superior overall power amplifier topology. The regulated PSU ensures stable, full output power over an extremely wide range of mains voltage levels. Sagging or fluctuating mains voltage will not affect the power output delivered to the loudspeakers.

4.2.2 AMPLIFIER GAIN

For greater flexibility in system integration, Q Series amplifiers allow gain adjustment from +23 dB to +44dB in 3 dB steps. This feature accommodates any combination of input device and loudspeaker type. For example, if the input signal is weak, the gain can be boosted to maintain maximum power output while avoiding a poor signal-to-noise ratio. This gain adjustment feature makes it easier to achieve an optimal balance between headroom and noise floor.

4.2.3 VOLTAGE PEAK LIMITING

The Voltage Peak Limiting (VPL) feature allows user adjustments that determine maximum voltage output, thus matching the amplifier to the connected speaker load. Whether the connected load is low impedance (8, 4 or 2 ohms) or high impedance (70 V / 100 V), the VPL feature can be set to ensure that neither temperature nor current limitations are exceeded before reaching the desired voltage threshold.

4.2.4 PROTECTION AND PERFORMANCE OPTIMIZATION

Appropriate and reliable power amplification is vital to any audio system. Inadequate or faulty power amplification could cause damage to the loudspeakers or in some cases to the power amplifiers themselves. To prevent any damage or costly service interruptions, Q Series amplifiers offer advanced features to protect both internal circuits and any connected loads. These features even protect the mains fuse that, in extreme cases, could be overloaded.

Following are short descriptions of standard built-in Q Series protection features:

- **CPL**, Current Peak Limiter ensures that the amplifier's output does not exceed the safe current handling parameters of amplifier components.
- **Temperature protection** ensures that the amplifier will not be damaged by exceeding thermal limits.
- **PAL**, Power Average Limiter limits the maximum average power consumption according to the power supply and mains-breaker capabilities.
- **VHF**, Very High Frequency protection circuits mute the output of the amplifier when non-dynamic continuous signals above 10 kHz are detected.
- **DC protection** ensures destructive DC signals will not appear at the amplifier outputs. If such conditions occur an internal fuse opens and fault indication is displayed.
- **Low impedance** (short circuit) protection provides a fault warning indication and shuts down the output stage when, for example, an input signal is present and a malfunctioning cable or driver is short circuiting the output.
- **High impedance** warning reports an alert when at the same time output signal is high, simultaneously, and no current draw is measured. This situation might occur when no speakers are connected, or when a driver is blown.
- **Low inrush current** ensures that the mains breaker will not trip when several power amplifiers are turned on simultaneously.

4.2.5 NOMADLINK / ETHERNET CONTROL AND MONITORING NETWORK

The NomadLink network allows easy setup and control of Q Series power amplifiers and other devices. The patented network topology allows automatic detection and addressing of multiple amplifiers, and is controlled from a PC via a bridge (MA-NET1) using standard TCP/IP communication. Phantom powering through the network cables allows the software to detect devices that are not currently turned on or connected to the mains. This ensures very high reliability and redundancy levels while allowing connected amplifiers to remain on standby with no power consumption.

Cable connections can be daisy-chained for easier system setup. This also reduces total component costs, simplifies installation, and makes daily operation more convenient. There is no need to create a star topology using many switches as with, for example, an Ethernet system. Individual amplifier addresses do not need to be manually entered. You will automatically know where an individual amplifier resides in the network.

A daisy chain network-loop, in combination with the automatic addressing of devices, enables the Q-Series' proprietary MA NetControl editor software to automatically create a precise picture of all connected devices and their relative position in the chain. This is the key to creating a quick overview of the system layout, allowing simple operation of a large group of amplifiers. Installation time is kept to a minimum, and fast access is provided to monitor performance and solve problems during operation.

Via NomadLink, you can monitor all metering data as well as all faults and warning indications simultaneously. NomadLink also allows you to remotely control power on and power off, as well as engage Mute and Solo functions on individual channels.

5. INSTALLATION

5.1 UNPACKING

Carefully open the shipping carton and check for any noticeable damage. Every Martin Audio amplifier is tested and inspected before leaving the factory and should arrive in perfect condition. If any damage is discovered, please notify the shipping company immediately. Only the consignee may institute a claim with the carrier for damage incurred during shipping. Save the carton and packing materials for the carrier's inspection. Should you ever need to ship the amplifier, always use the original packaging materials.

5.2 MOUNTING

The amplifier is two rack units high (2U) and will fit into a standard EIA 19" rack.

The depth is 343 mm (13.5").

The weight is approximately 12 kg (26.4 lbs.) depending on model type.

Free airflow from front to rear of the amplifier must be possible. Therefore, no doors or rack-lids should be mounted in front of or behind the amplifiers.

Amplifiers may be stacked directly on top of each other. There is no need for spacing in between units, though this might enable more convenient installation of cabling on the rear-panel.

It is recommended that rear supports be mounted for maximum long-term stability.

5.3 COOLING

The amplifier uses a forced-air cooling system with air flow from front to rear, maintaining a low operating temperature within defined limits. Front-to-rear airflow is preferred as cooler air is present at the front in nearly all installed applications. (This allows higher continuous power levels without encountering thermal problems.) Never attempt to reverse the airflow. The amplifier modules require a pressure chamber between the fans and heatsink, and this effect functions only in one direction.

Make sure that there is an adequate air supply in front of the amplifier, and that the rear of the amplifier has sufficient space to allow the exhaust to escape. If the amplifier is rack-mounted, do not use covers or doors on the front or rear of the rack.

Should a heat sink overheat, the temperature sensing circuits will mute the overheating channel. If the power supply overheats, another sensing circuit will mute all output channels until the power supply cools to safe operating temperature. An early warning before shut down will be indicated on the front panel LEDs, and a warning will be sent through the NomadLink network.

Always make sure that the dust-filters behind the detachable front panel are clean to ensure maximum possible airflow.



If the amplifier malfunctions due to dirty dust filters, any required repairs are not covered by the warranty.

To calculate the maximum heat emission value, when installing the amplifiers in rooms with an air-conditioning system, please refer to the BTU specifications provided in the Appendix section.

5.4 OPERATING VOLTAGE



The label placed to the right of the mains cable on the rear of the amplifier indicates the AC mains voltage for which the amplifier is wired and approved: 115 V or 230 V. Connect the power cable only to the AC source type referred to on the label. The warranty will not cover damage caused by connecting to an incorrect type of AC mains.

Martin Audio switch mode amplifiers use primary switching. Because the mains power is rectified directly in front of the transformer, the amplifier is insensitive to mains frequency. It may be connected to 50 or 60Hz sources, and actually will operate on line frequencies from DC to 400 Hz.

If the power plug mounted at the factory is not appropriate for your country, it can be removed and the proper connector wired in its place as follows.

BLACK or BROWN	LIVE
WHITE or BLUE	NEUTRAL
GREEN or GREEN/YELLOW	EARTH(GROUND)

Warning: If you are not 100% confident of your competence to replace the mains plug, engage qualified personnel to do the job.

Once a suitable AC supply is connected, the amplifier can be turned on using the front panel power switch. The amplifier then goes through a soft-start sequence as it self-checks its circuits. The fans will blow at high speed before dropping to idle, and the “power” LED will illuminate.

Inrush power is controlled and limited during “soft start”, enabling multiple amplifiers to be powered up simultaneously.

5.5 GROUNDING

There is no ground lift switch or terminal on the Q Series amplifiers. The signal ground is always floating, via a resistor, to chassis and therefore the grounding system is automatic.

In the interests of safety, never disconnect the earth (ground) pin on the AC power cord.

Use balanced input connections to avoid hum and interference.

6. QUICK GUIDE OVERVIEW

6.1 FRONT PANEL OVERVIEW

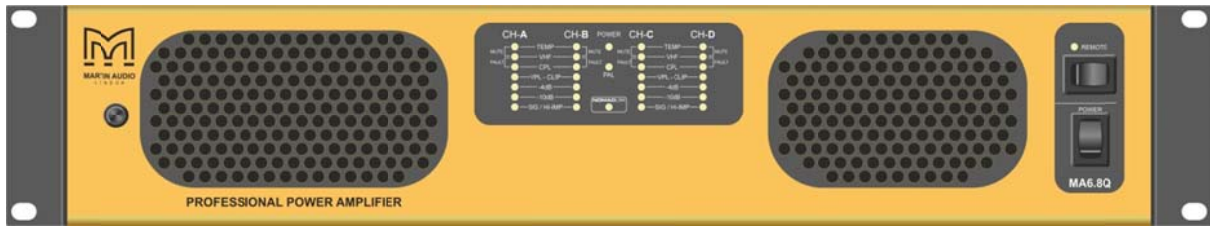

The amplifier's front panel presents the performance and fault condition indicators, power and remote switches, and a removable dust-filter cover. Four level potentiometers located behind the cover provide individual attenuation for the four amplifier channels. Range is 0 dB to - infinity. The 12 o'clock position indicates -10 dB attenuation.

To remove the dust-filter cover, loosen the thumbscrew at the far left. This allows removal of the dust filters for cleaning, and provides access to channel attenuation. The front cover may be made "tamper resistant" by replacing the thumbscrew with Philips head or safety Torx screw. Thread size is M3.

6.1.1 POWER ON/OFF AND REMOTE SWITCH

The Power on/off switch is located on the right side. A second switch, labelled "REMOTE," is above the Power switch. When the Remote switch is on, the yellow LED above it will illuminate indicating that external power on/off commands from the NomadLink network connection will switch the amplifier on or off. When Remote is activated the amplifier will not switch on until a "Power On" command is received from the network. When the remote switch is off, it is not possible to switch amplifier power on or off using NomadLink network control.

6.1.2 FRONT PANEL LED'S

The front panel LED area includes the following indicators per channel:

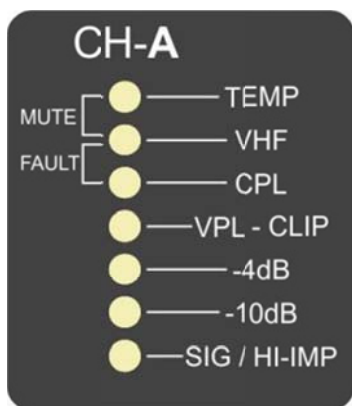

- Temperature warning (Yellow flashing)
- Temperature mute (Yellow constant)
- Very High Frequency protection active (output muted) (Yellow)
- Mute channel via NomadLink network (2x Yellow)
- Current Peak Limiter (CPL) active (Orange flashing),
- CPL constant (output muted): Lo impedance / Short circuit detection
- Fault (Yellow plus Orange)
- Voltage Peak Limiter (VPL) active, VPL/Clip (Red)
- 4 dB signal level (Green)
- 10 dB signal level (Green)
- 40 dB signal level (Green),
- Hi-Imp open load detected (Red)



When no VPL, CPL or PAL indicators are illuminated, the amplifier channel is able to deliver maximum rated output power.

Common LED's on the front panel:



- Power on (Green)
- Power Average Limiter active (PAL) (Red)
- NomadLink network active (Blue).



When the network is connected, the blue NomadLink LED will illuminate even when mains power is not connected. NomadLink receives phantom power from the network supplied by the MA-NET1.

6.2 REAR PANEL OVERVIEW

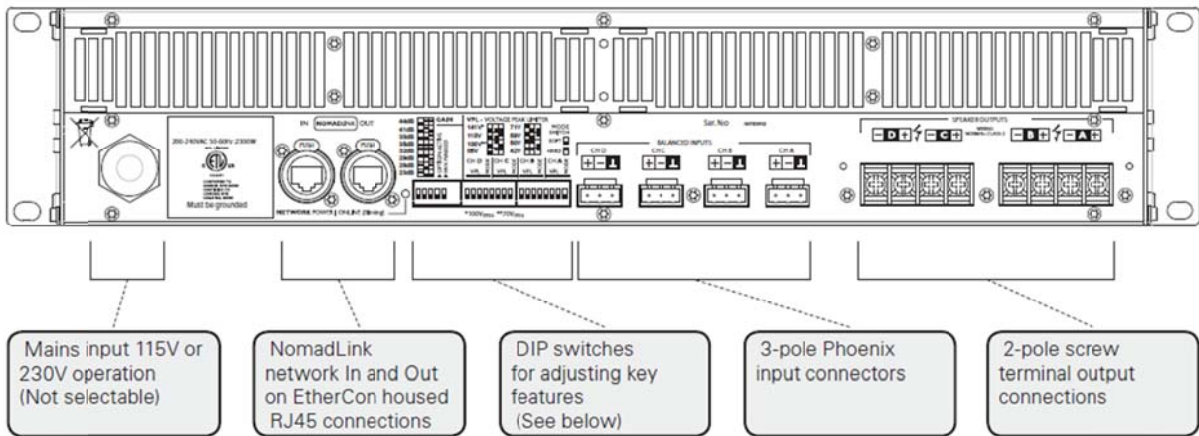

6.2.1 THE DIP SWITCH FEATURES

The following features may be adjusted using the DIP switches on the rear-panel of the amplifier.

Gain - Set for all four channels from +23 dB to +44 dB in 3 dB steps.

Option active - Available for future upgrades.

Fan Masked - When on, engages the intelligent fan feature lowers fan speed when no signal is present.

VPL - Voltage Peak Limiter adjustment is provided for 8 individual levels. Select the setting most appropriate for connected speakers. See Appendix for details.

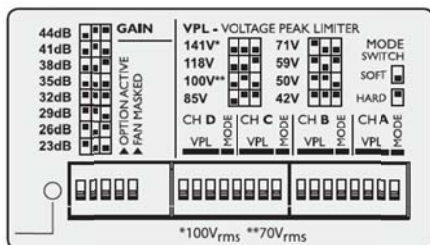

Mode - Select VPL mode between Hard and Soft. For channels driving sub-woofers and Lo-end frequencies, it is recommended to use the Hard setting for optimal operation. For mid and hi-end drivers, always select Soft.

6.3 NOMADLINK / ETHERNET NETWORK SETUP

The amplifier includes, as a standard feature, internal facilities for the NomadLink monitoring and control network. All features of the NomadLink network are accessible via a PC running proprietary MA Net Control software. A single rack space network bridge, the MA-NET1, accepts the TCP/IP data stream from the computer and converts it to the NomadLink protocols. Even when no computer is connected, the MA-NET1 can initiate stand-alone power on/off and muting functions, as well as report any fault or warning conditions.

The PC is connected to the MA-NET1 using a standard Ethernet interface and a crossed Cat5 cable (peer-to-peer setup). If a HUB or switch is in the network, standard "straight" Cat5 cables must be used. The front and rear Ethernet connections on the MA-NET1 can be used individually, but only one PC at a time running MA Net Control can access the subnet.

The default fixed TCP/IP address of the MA-NET1 is 192.168.1.166. The subnet mask is 255.255.255.0. For further details, please refer to instructions supplied with the MA-NET1 unit.

The NomadLink connections use standard "straight" Cat5/RJ45 equipped cables. For a safer mechanical connection it is possible to use Neutrik EtherCon "XLR-type" housings on the cables.



US National Differences cl.16.3 requires that NomadLink network cables must be rated VW-1.

The OUT port from the MA-NET1 must be connected to the IN port of the first amplifier. The OUT port from the first amplifier in turn connects to the next amplifier's IN port to form a daisy chain. The OUT port on the last amplifier is connected to the IN port on the MA-NET1 to close the loop.



There are electrical limitations to cable lengths on a NomadLink network, both in terms of total cable length in the loop and between any two devices. Read the Operation and Performance chapter in this manual, or the instructions supplied with the MA-NET1, to ensure the network is configured within these constraints.



Although the network will function as an open loop under most circumstances, it is strongly recommended that the loop be closed by connecting to the MA-NET1's IN port. Doing so will improve redundancy and communication speed.

External contact closures and 24 V low/high triggers can be connected to GPI connectors on the MA-NET1 for control of fire-alarm systems or external power sequencers. For more details read the instructions supplied with the MA-NET1.

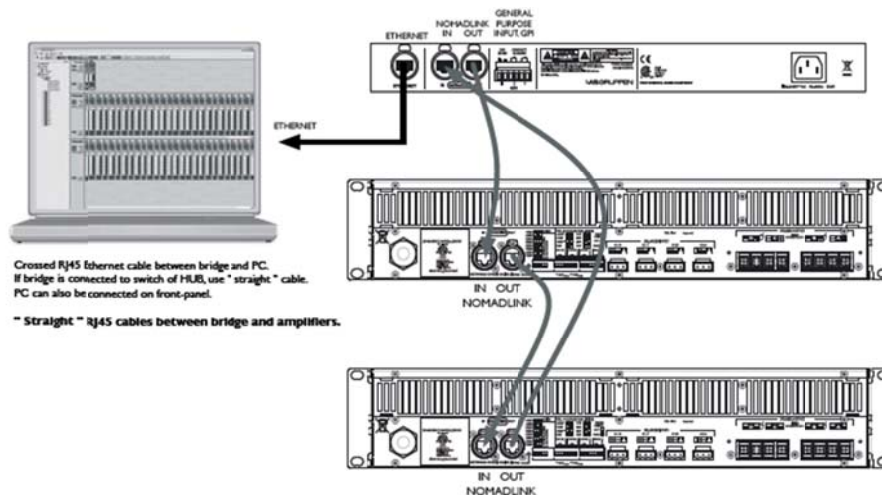

7. OPERATION AND PERFORMANCE

7.1 INTRODUCTION

The following sections provide comprehensive information on amplifier connection, setup, operation, and performance. The detailed information included here is essential to realizing the full functionality of the Q Series amplifiers.

7.2 OPERATION PRECAUTIONS

- Make sure that the Power switch and the Remote switch on the amplifier front panel are set to “off” before making any input, output or network connections, and also before manipulating the DIP switches on the rear-panel.
- Make sure that the AC mains voltage is correct and matches the voltage printed on the rear panel of the amplifier (115 V or 230 V).
- Make sure that no signal is present at the input to the amplifier when powering up. This will produce an unintentionally loud initial volume from the speakers.

7.3 SIGNAL FLOW AND HEADROOM

7.3.1 SIGNAL FLOW BLOCKS

All Q Series amplifiers have the same signal flow and feature set. The only difference is the amplifier’s maximum output current per channel.

The input stage of all Q Series amplifiers has a high sensitivity to provide ample system headroom. This in effect means that the input stage is almost impossible to clip.

Overall amplifier input gain is adjusted using the input stage DIP switches. Please note that the gain setting is global, affecting all four channels. Following the input stage, the dedicated level control on each channel allows signal attenuation from 0 dB to minus infinity.

The Current Peak Limiter (CPL) section dynamically limits the input signal based on three parameters: sensed current level, feedback from the output stage, and sensed voltage clip from the VPL (and output amplifier voltage clip if “Soft Clip” activated). This ensures that power output is maintained within the design limits of the amplifier.

The adjustable Voltage Peak Limiter (VPL) sets the maximum output voltage and therefore also the maximum output power. Eight (8) different voltage stages are available using the DIP switches on the rear-panel. See table in Appendix section with VPL ratings at typical loads.

The sophisticated output section monitors faults and generates appropriate warnings, which are displayed on the amplifier front panel and transmitted through the NomadLink network. These alerts allow the operator to adjust system settings and thereby avoid problems. In the rare event that conditions are extraordinarily severe, the amplifier will shut down until the fault or problem setting has been rectified or adjusted. These sensing circuits are also employed to feed-back voltage and current level information, via a side chain, to the limiters. Sensing circuits also transmit local amplifier module temperature and power supply temperature to the appropriate protection mechanisms. Read the Protection, Faults and Warnings section for further details.

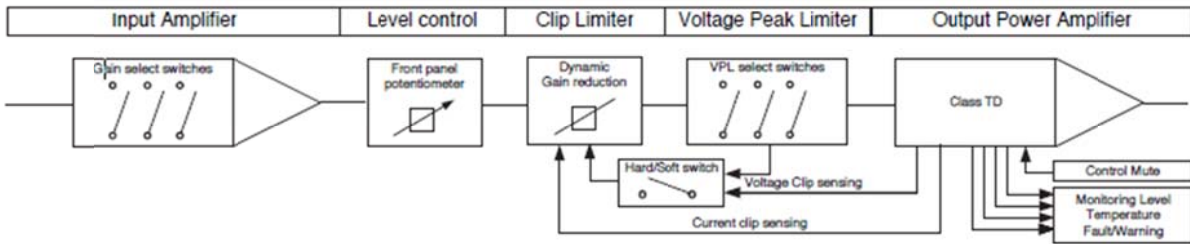

7.3.2 HEADROOM, SENSITIVITY AND VPL / GAIN SETTINGS

The input amplifier and limiter system is designed to accommodate extremes of performance. Typically, exceeding maximum input by much as +10 dB will only result in a 1% increase in distortion. The following schematics illustrate how the adjustable VPL and Gain circuitry affect input sensitivity and output power:

The tables to the left of the drawing below, show input sensitivity for MA6.8Q with an 8 ohm load and 141 V_{peak} (max.) and 42 V_{peak} (min.) respectively for the eight different gain stages between +23 dB and +44 dB. The resulting output power is displayed in dBu, V_{rms} and Watt in the tables to the far right. Complete input sensitivity tables for all VPL and Gain settings for all Q Series models, can be found at www.martin-audio.com.

The headroom available through the input stage to the clip limiter is shown by the dotted lines as +10 dB at 141 V_{peak} and +20.4 dB at 42 V_{peak}. These lines illustrate the additional signal level that can be accepted at the input before any significant distortion will appear at the input stage.



If you use the level potentiometer in the signal chain to reduce the level by an amount greater than the headroom relative to input sensitivity, AND you drive the amplifier to clip level, you are in danger of clipping the input stage before the current or voltage peak limiters are activated.

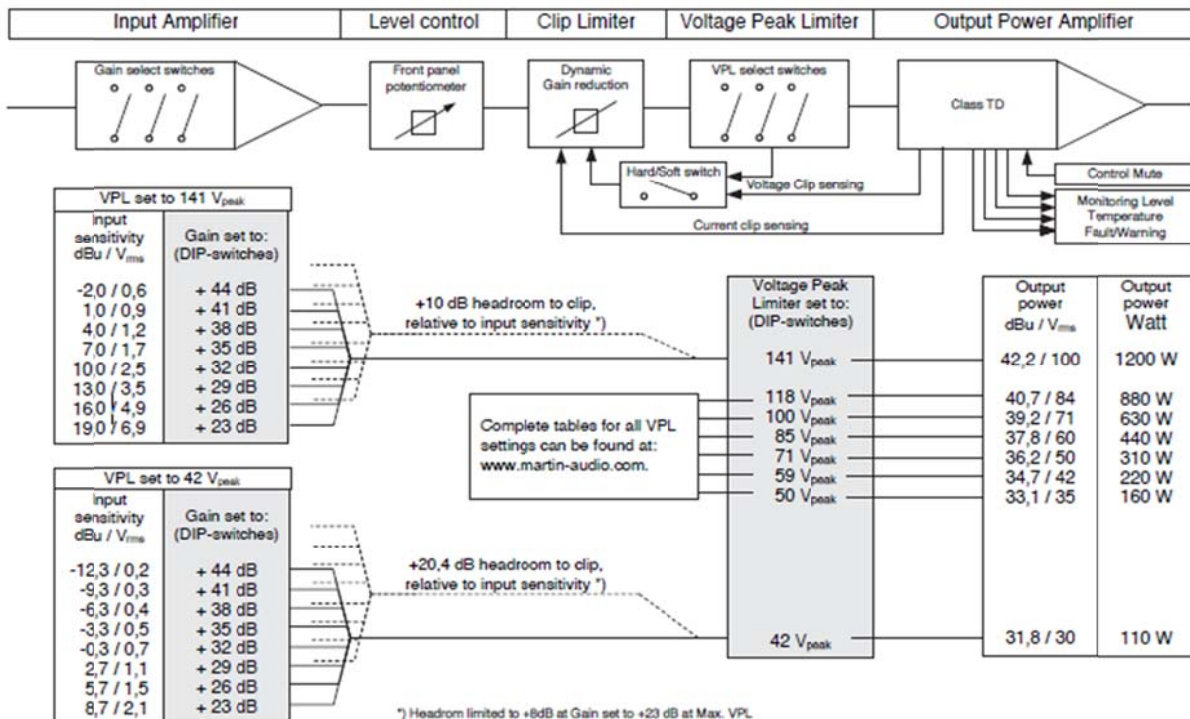

7.4 AUDIO INPUT AND OUTPUT CONNECTIONS, SETUP AND FEATURES

7.4.1 BALANCED / UNBALANCED INPUT CONNECTION

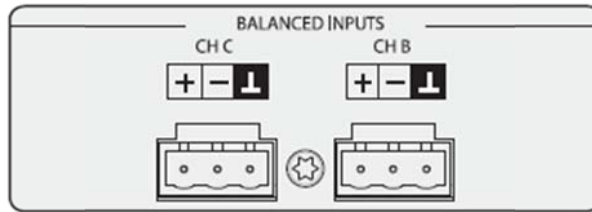

Four electronically balanced Phoenix-type inputs are available. Follow the +,– and Ground labels when connecting the input signal.

If an unbalanced connection is desired this can be achieved by summing the minus (“COLD”) and Ground terminals and using the + terminal as the “HOT” signal. For the best possible performance, the summing of ground and minus wires should be done at the source unit end of the cable (e.g. a CD player).

Four connectors are supplied for attaching cables to the inputs. The type of connector used is: Phoenix Contacts, Part number MSTB 2,5/3-STZ-5,08



When linking the same source signal to several input channels, be aware that there is a limit to the number of channels an output source can “drive”. A typical output source (e.g. a DSP crossover unit) can drive up to 4 amplifier channels before line-drivers would be required to buffer the signal.

7.4.2 OUTPUT OPERATION AND CONNECTION

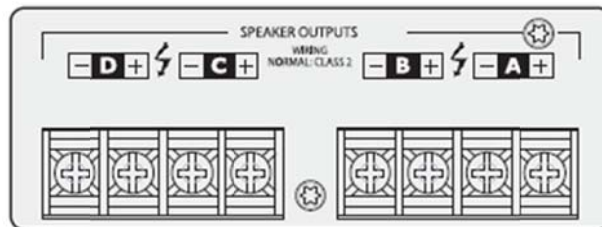

Screw-terminal connectors with + and – poles are provided at each channel output for connection of the speakers. Make sure that the speaker cables are connected correctly and tightly, and that accurate polarity is maintained to all speakers in the system.



As the amplifier outputs produce high voltage, do not connect or disconnect speaker cables when the mains power is on. Also, attach the safety cover on the speaker terminals for safe operation and to comply with electrical product approvals.

7.4.4 AMPLIFIER GAIN

All Q Series amplifiers feature adjustable input gain. This versatility enables the amplifier to accommodate a multitude of system configurations with various input sources and speaker layouts.

Amplifier gain is set globally for all four channels. The range is +23 dB to +44 dB in 3 dB steps. Individual channel fine level adjustment is available using the potentiometers on the front panel.

The unique adjustable input gain feature of the Q Series makes it easier to attain the optimum balance between headroom and signal-to-noise ratio in the signal path. A weak signal at the input might require the gain to be raised in order to achieve maximum output power with the lowest signal-to-noise ratio. A “hot” input signal, however, would require a lowering of the gain to avoid sending the amplifier into Voltage or Current clipping.

See Appendix to review the table containing Gain versus VPL setting implications for input sensitivity and output power. Note that Martin Audio strongly recommend using a gain setting of 32dB, this has become something of an industry standard having proved to be a high enough gain to receive drive from the majority of signal processing products without them having to drive their output too close to clip, whilst being low enough to produce acceptable signal to noise ratio. All Martin Audio published parameters for speaker products have limiter threshold settings based on an amplifier gain of 32dB.

7.4.4.1 CHANNEL GAIN/LEVEL (FRONT PANEL POTS)

Individual channel gain (level) may be adjusted using the potentiometers located on the front panel behind the dust-filter cover. Range is from 0 dB to –Infinity in 21 steps. The attenuation is logarithmic, with the 12 o’clock position indicating -10 dB.



Use your fingers or a screwdriver to adjust the potentiometers. If the level control is used to attenuate to a lower level than the headroom relative to input sensitivity AND the amplifier input is driven into clip, there is a danger of clipping the input stage before the current or voltage peak limiters are activated.

7.4.4.2 AMPLIFIER SENSITIVITY

Sensitivity is defined as how many Volts (rms) or dBu (referred to 0.775 V_{rms}) are required to achieve full (maximum) output power. As the output power varies with the load impedance, 4 ohms is usually the common reference.

Since Q Series amplifiers are capable of providing multiple maximum output power levels through use of the VPL feature, many sensitivity calculations may be required for a single amplifier. We recommend use of the MA NetControl editor to simplify this process. MA NetControl’s device view page, used in combination with the DIP switch settings display, will automatically produce a sensitivity calculation from the given data (VPL, Gain and load).

7.4.5 OUTPUT VOLTAGE PEAK LIMITER (VPL)

Voltage Peak Limiter (VPL) is a unique feature in Q Series amplifiers. It is used to select the maximum power available on each output channel. Eight levels can be set using the DIP switches on the amplifier’s rear panel.

V_{peak}	V_{rms}
141	100
118	84
100	70
85	60
71	50
59	42
50	35
42	30

The values for VPL are displayed as maximum Voltage Peak. To translate Voltage Peak into V_{rms} , you must divide the Voltage Peak values by 1.41 (see table).

The VPL allows you to set the correct maximum output peak power for optimum performance with the connected speakers. The correct setting depends on the system type (lo-or hi-impedance) and the specific load connected to the channel. Since each channel can be configured to deliver either very high voltage peak power OR high current draw at low impedances, it is important to set the VPL correctly.

To configure an individual output channel for a constant voltage system, you simply adjust the DIP switches to the desired voltage. However, when using an output for a low impedance system (2, 4, 8 or 16 ohms), then sometimes you need to adjust the VPL to a lower setting to avoid either delivering excessively high continuous power to the speaker or overheating of the output channel through high current draw. For example, with a very “hot” continuous output signal, the temperature could rise to a critical level and activate Temp warning or even Temp Mute. Lowering the VPL setting normally will solve this situation.

If the Current Peak Limiter is active or indicates low impedance, lowering the VPL setting can rectify this situation as well.

7.4.6 CONSTANT VOLTAGE 70 V AND 100 V SYSTEMS SETUP AND OPERATION

When using Q Series amplifiers to drive constant voltage (hi-impedance) speaker systems at 70 V_{rms} or 100 V_{rms}, you can in most cases simply connect the speakers to the amplifier output terminals, select the correct VPL setting, and place the amplifier in service.

7.4.7 OUTPUT CURRENT PEAK LIMITER (CPL)

The Current Peak Limiter (CPL) ensures that the amplifier will not be damaged by trying to deliver more current to the outputs than that physically possible for the transistors. The CPL keeps the amplifier within the Safe Operating Area. The CPL is non-adjustable and has different limit values depending on model type. The maximum output current values for the four Q Series models are:

MA6.8Q, 24.5 Arms per channel
MA4.8Q, 17.5 Arms per channel

CPL activity is indicated by illumination of an orange LED for each channel on the front panel. Warnings also are shown in the MA NetControl software’s GUI.

A steadily illuminated orange CPL LED indicates a short circuit situation (or very low impedance). The output will mute for 6 seconds before measuring the output impedance again. This will continue until the short circuit is fixed, at which time the output will automatically un-mute. An input signal must be present to allow detection of short circuit or low impedance conditions.



If the CPL LED is steadily illuminated orange while the output is muted and the -4 dB signal LED is NOT on, then the amplifier output is detecting a short circuit or low impedance condition. The problem can be solved by checking input and output cables and examining the state of the loudspeaker load. If there is no short circuit present, then the condition may be rectified by lowering the VPL or input levels.

If the CPL and -4 dB indicators are lit simultaneously, then the amplifier is delivering too high a current and is being forced into a current limiting state (output muted).

7.5 PROTECTION, FAULTS AND WARNINGS

7.5.1 INTRODUCTION

The Q Series amplifiers incorporate a sophisticated and comprehensive set of protection features. Faults and warnings are indicated on the front panel and reported via the NomadLink network for indication on the MA NetControl GUI.

7.5.2 SAFE OPERATING AREA DETECTOR (SOAD)

The Safe Operating Area Detector (SOAD) compares output voltage against output current to ensure that the output transistors are working inside their safe operating area.

The SOA detector provides fault monitoring and input to the Current Peak Limiter (CPL). The SOA detector has no dedicated indicator, and its operation is revealed only in conjunction with features such as the CPL.

7.5.3 VERY HIGH FREQUENCY PROTECTION

All Q Series amplifiers include protection circuits that detect continuous Very High Frequency content in the input signal. The detection begins at approximately 10kHz and moves upwards to include ultrasonic signals. If VHF signals are detected, the output will mute for 6 seconds before re-measuring. Once no continuing VHF signal is detected, the output un-mutes and returns to normal operation.

This feature recognizes that continuous full-scale VHF signals do not appear in “natural” sources such as music. Any such signals can therefore be considered as a fault when present. VHF protection is essential in avoiding damage to high frequency drivers.

The VHF protection operational area is dependent on output power level and frequency. The illustration below shows a decreasing threshold on the output power level, starting at approximately 10 kHz and rising with a -6 dB slope. This defines the VHF protection area. When continuous output power above the threshold line is detected the VHF protection becomes active.

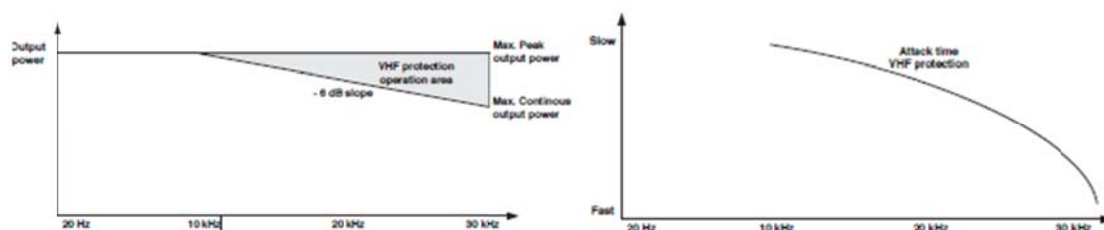

The Attack time for the VHF protection is increasingly shorter at higher frequencies. For example, an ultrasonic continuous signal will cause the outputs to mute rapidly, where it will take several milliseconds for a 10 kHz continuous signal to trigger the output mute. This is shown in the illustration above.

The VHF protection is NOT a limiter and does not alter the amplifier’s frequency response. It is implemented solely to detect continuous VHF content. The amplifier will always pass VHF peaks at full power, with no effect on musical “transients”.

The VHF protection is indicated by a yellow LED on the amplifier front panel, with output muting for 6 seconds when in action. It is reported as a fault via the NomadLink network on the MA NetControl GUI.



If you bench test the amplifier using a continuous, full scale sine-wave input above 10 kHz, the VHF protection will activate and prevent measurement of full peak output power. (Output will be muted long before maximum output power is attained.) To measure the true peak output power, use a burst signal.

7.5.4 DC PROTECTION

DC protection is implemented on each output to prevent damage to connected loudspeakers. DC present at the output will trigger muting and illuminate the fault LED indicator. Any DC present at the output indicates a hardware malfunction that requires servicing of the amplifier.

7.5.5 HI IMPEDANCE WARNING (OPEN LOAD)



A high impedance (open load) condition is indicated when an input signal above approximately -29dB is detected and no functioning loudspeakers are connected to the amplifier. The fault is indicated by a red Sig/Hi-imp LED. The indicator is green when a valid load is present under the same input signal conditions. Since the Hi-impedance detection initially triggers only when the input signal rises above -29dB, it might cause the indicator to first turn green, and then red, even in situations where no speaker is connected.

7.5.6 LO-IMPEDANCE PROTECTION (SHORT CIRCUIT)

A lo-impedance or short circuit fault is detected when current draw is high (Current Peak Limiter active) and when, simultaneously, output signal is low (-4 dB LED does not illuminate). When this occurs, the amplifier protects the output stage from damage by muting the output signal and bypassing the circuits. Indication of this fault is a constant orange illumination of the Current Peak Limiter (CPL) LED on the front panel. The protection will sequence at 6 second intervals to re-measure conditions. If the low-impedance fault is no longer detected, the amplifier will un-mute.



If the CPL turns constant orange, the output is muted, and the -4dB signal LED is ON, then the amplifier has gone into maximum current protection. This situation is caused by an excessive input signal and is not due to a short circuit. Turn down the input signal to avoid or remedy this situation.

7.5.7 TEMPERATURE PROTECTION

Thermal measurement points are provided on each output channel as well as on the power supply. These indicators will, if the pre-specified temperature level is exceeded, give a high temperature warning. This warning condition is indicated by a flashing Temp LED on the front panel and it is reported on the MA NetControl GUI via the NomadLink network.

As the amplifier approaches a thermal protection threshold, the warning LED sequence will start with short “on-time” bursts. If the amplifier continues to overheat and approaches the temperature limit, the flashing sequence will be defined by longer and longer on-time bursts until the protection mode is activated.

If the temperature becomes too high to continue safe operation, the overheated output channel(s) will be muted until the temperature returns to an acceptable level.

Fully active temperature protection (with muting) is indicated by a constantly illuminated Temp LED. It will also be indicated as a fault via the NomadLink network on the MA NetControl GUI.

Temperature measurements will continue at 6 second intervals. The output will un-mute when the channel or power supply returns to a safe operating temperature.

7.5.8 POWER AVERAGE LIMITER (PAL)

The Power Average Limiter (PAL) controls the current-drawing relationship between the power supply and the mains inlet. PAL limits the maximum average power consumption according to the power supply capabilities, ensuring that the PSU will not overload. In addition, in the larger models that potentially could pull more current from the mains than the mains-fuses are specified to handle (more than 16 A), PAL limits the amplifier's maximum current draw to prevent blowing the mains fuse.

7.5.9 SOFT START

High powered amplifiers with inadequate inrush limiting can pull considerable current from the mains at turn-on. This can result in fast acting mains breakers tripping. Such is not the case with Q Series amplifiers. The Q Series amplifiers have very low inrush power as the capacitors are charged slowly and in a controlled manner ensuring that breakers will not trip.

Several amplifiers will, under normal conditions, be able to be powered up simultaneously. If you do experience problems powering up multiple amplifiers simultaneously, use the NomadLink network and the NLB60E to establish a power sequence with a pre-set delay between each amplifier start-up.

7.6 FRONT PANEL MONITORING AND ADJUSTMENTS

7.6.1 LEVEL INDICATORS

Four signal / level / clip LEDs per channel are contained on the Q Series front panels:

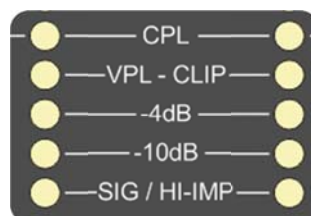

1. Orange CPL (Current Peak Limiter) flashing indicates signal exceeds maximum output current.
2. Red VPL/CLIP indicates that the signal has exceeded maximum output voltage. This activity is governed by the rear panel VPL settings.
3. Green - 4 dB indicates output signal has reached this level.
4. Green - 10 dB indicates output signal has reached this level.
5. Signal / Hi-Imp (Green/red) indicates an output signal above -44 dB. If it turns RED, this indicates that a high impedance ("open" connection) has been detected at the output. This can be a fault such as a disconnected cable or the driver is not functioning properly. However, it could indicate acceptable high impedance, such as a sub-bass enclosure with high impedance at a certain frequency. When the -10 dB signal LED is on AND the Hi-Imp. LED turns red, then the amplifier has detected an open load no speaker is connected).

For more detailed signal level indications use the MA NetControl editor application.

8.6.2 LEVEL ADJUST

Step	Attenuation
1 (Min)	-Inf. dB
2	-Inf. dB
3	-50 dB
4	-40 dB
5	-35 dB
6	-21.5 dB
7	-21.5 dB
8	-14.7 dB
9	-12.9 dB
10	-11.4 dB
11	-10.0 dB
12	-8.7 dB
13	-7.4 dB
14	-6.0 dB
15	-4.5 dB
16	-2.7 dB
17	-0.6 dB
18	-0.3 dB
19	-0.1 dB
20	0 dB
21 (Max)	0 dB

Level adjust potentiometers (one per channel) are located behind the removable dust filter cover on the amplifier's front panel. With the dust cover in place it is not possible to adjust the level settings.

The potentiometer's operational range is 0 dB to -Infinity in 21 steps. Attenuation is logarithmic, with 12 o'clock position being -10 dB. See table to the right with increments.

It is not possible to adjust the individual channel attenuation from the NomadLink network or elsewhere on the amplifier.

Use fingers or a screwdriver to adjust the potentiometers.

7.6.3 MUTE INDICATION

Individual channel Mute is indicated by illumination of the two yellow LEDs at the top of the channel's LED bargraph. Mute/Un-mute can only be performed from the network using either the MA-NET1 and/or the MA NetControl PC editor.

7.6.4 PERFORMANCE, WARNING AND FAULT INDICATORS

- **Power on/off** (green) indicates that mains power is switched on.
- **NomadLink** (blue) indicates that the network is connected. The NomadLink LED will light up even before the mains power is connected and switched on as it takes phantom power from the network cable.
- **CPL, Current Peak Limiter** (flashing orange), indicates the maximum possible current draw has been reached.
- **CPL, Current Peak Limiter** (constant orange), when constant indicates excessive current draw caused by a short circuit on the output or very low operational impedance. When detected, the output will mute for 6 seconds before re-measuring the output impedance. This will continue until the short circuit is removed. CPL remains constant orange in a fault condition only when an input signal is present.
- **Temperature** (yellow) warning is indicated by a flashing LED. If the amplifier goes into thermal protect (output muted) the LED illuminates constant yellow.
- **VHF**, Very High Frequency protection (yellow), indicates that potentially harmful continuous high frequencies have been detected on the input signal. The output is muted.
- **PAL**, Power Average Limiter (red), indicates that the amplifier is limiting because the power supply and/or the mains-inlet fuse has reached maximum capability.
- **Hardware fault** is indicated when both the CPL and VHF indicators light up simultaneously. The amplifier requires servicing before placing back in operation.

7.7 NOMADLINK NETWORK AND PC EDITOR

7.7.1 NOMADLINK NETWORK IN THE AMPLIFIERS

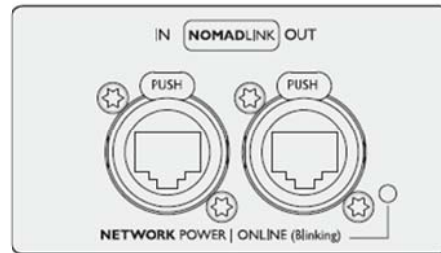

All Q Series amplifiers are equipped with the proprietary NomadLink network interface. This includes two Neutrik EtherCon housed RJ45 connections: one IN and one OUT.

Use standard straight Cat5 Ethernet cables with RJ45 connectors to connect the amplifier to the MA-NET1 network bridge or to daisy-chain multiple amplifiers.



It is very important that two IN or two OUT ports are NEVER connected to each other. This will cause the NomadLink communication and MA NetControl editor to exhibit erratic behaviour and display inaccurate data. However, this situation will not damage the amplifier circuitry.

Up to 60 amplifiers can be connected to one MA-NET1 in a daisy-chain or closed loop.

When the MA-NET1 bridge is powered up, the NomadLink network receives phantom power. This causes the blue NomadLink LED on the amplifier front panel and the NomadLink LED on the rear-panel to light up. NomadLink is active even when the amplifier has mains power disconnected or is not yet powered up.

The amplifier does not have a stand-by power supply for the network. The network is solely powered from the MA-NET1. Should an amplifier fail or be inadvertently disconnected from the mains, network integrity is fully maintained and all amplifiers remain visible on the system.

7.7.2 CONNECTION AND SETUP

The NomadLink network requires use of a MA-NET1. The NomadLink network is established by connecting the MA-NET1 OUT port to the first amplifier's IN port. Then a daisy-chain is established by connecting the first amplifier's OUT port to the next amplifier's IN port, and so on. If a closed loop network is desired for improved redundancy (highly recommended), the last amplifier's OUT port must be connected to the MA-NET1's IN port.

For all connections, straight Cat5 RJ45-equipped Ethernet cables should be used.



Optimal NomadLink performance can only be assured when using Cat5 cables. However, as NomadLink is only using two wires + ground for communication and phantom power it is possible to create converters from RJ45 to, for example, XLR connectors using 2-wire shielded cable. The NomadLink network can then be operated using a standard tie-line in a multicore signal distribution system. See the drawing below for an example of how to create a converter.

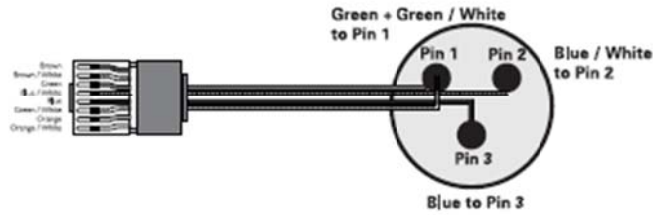

If any cable format or connection other than Cat5 (or better) and RJ45 is utilized, network performance may be compromised. In this event **Martin Audio** cannot guarantee that the NomadLink network will be fully operational.

7.7.3 NOMADLINK NETWORK CABLE LENGTHS

In situations where the amplifiers and the MA-NET1 will be positioned in different locations at some distance from each other, or where groups of amplifiers within a single subnet with up to 60 units will be installed with a distance in between, these general rules may be considered:

- **Rule 1:** The maximum cable length in between any two devices may not exceed 300 meters / 980 feet.
- **Rule 2:** In a non-closed-loop daisy-chained subnet the total maximum cable length is 400 meters / 1300 feet.
- **Rule 3:** In a closed-loop subnet the total maximum cable length is 700 meters / 2300 feet.

Below are typical examples of NomadLink network setups:

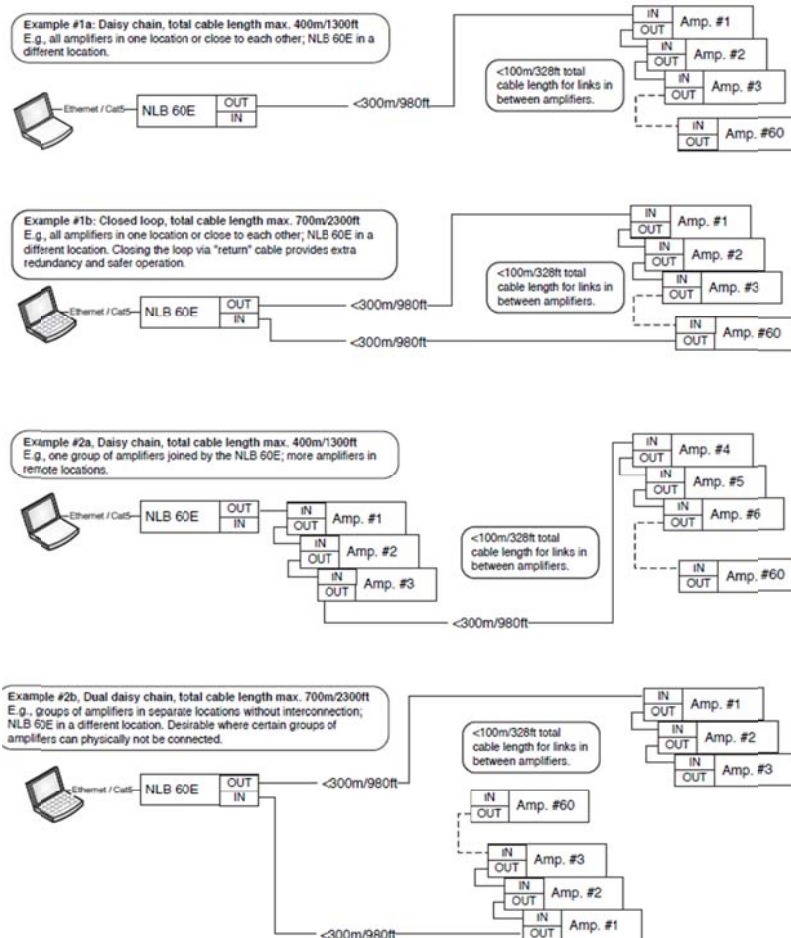

7.7.4 ETHERNET NETWORK CABLE LENGTHS

The connection between the MA-NET1 and your PC is a standard Ethernet network running the TCP/IP protocol. Cable distances between MA-NET1 and your PC follow standard rules for Ethernet systems.

Contact your IT expert for more details.

7.7.5 MA NETCONTROL EDITOR

The MA NetControl editor is a proprietary software application for monitoring and controlling networked Q Series power amplifiers. MA NetControl runs on a Windows PC, which connects via Ethernet to the MA-NET1 network bridge. MA NetControl provides comprehensive monitoring of amplifier status as well as control of amplifier power on/off and individual channel mute and solo functions.

Please review the MA NetControl user manual for more detailed information.

8. APPENDIX

8.1 MAINTENANCE

During normal operation your Q Series amplifier will provide trouble-free service. The only user maintenance required is to periodically vacuum clean the foam dust filters behind the front grille.

In some extreme cases it may be necessary for authorized service personnel to clean the inside of the amplifier. These conditions usually occur after prolonged use in extreme environments such as those using “cracked oil” smoke machines. If you are using your amplifier in a heavy duty application, it is recommended to have your amplifier serviced every 3 years purely as a preventative action.

8.2 FAQ

Following are common questions asked about Martin Audio's Q Series power amplifiers together with helpful answers.

Q: What is the input sensitivity of the amplifiers?

A: Input sensitivity is calculated from the amplifier gain, maximum output voltage and load. As gain and output voltage is adjustable in Q Series amplifiers, you need to look this information up in a table found in the Appendix section of this manual. Input sensitivity also is automatically calculated in the MA NetControl editor software application.

Q: What are the maximum cable lengths allowed when using the NomadLink network?

A: NomadLink uses a daisy-chain topology to connect amplifiers and an MA-NET1 bridge in a network. Standard RJ45-equipped Cat5 cables are used throughout. The daisy chain may be made into a closed-loop by connecting a return cable to the MA-NET1 from the last amplifier.

General rules of cable lengths:

- The maximum cable length in between any two devices may not exceed 300 meters / 980 feet.
- In a non-closed-loop daisy-chained subnet the maximum cable length is 400 meters / 1300 feet.
- In a closed-loop subnet the maximum cable length is 700 meters / 2300 feet.

Exceeding these limits may result in lost contact with the devices, or loss of phantom powering due to cable resistance.

Q: How long can cable-runs be on the Ethernet network connecting the MA-NET1 to the PC?

A: On the Ethernet side, normal Ethernet cable limits apply. This is typically a maximum of 80 meters / 300 feet between each device. Follow standard installation procedures for Ethernet. Distances beyond 100 meters may require use of a repeater, a format converter, or optical cables.

Q: Why is the NomadLink network a closed-loop topology?

A: Technically speaking, the closed loop is optional. The purpose of closing the loop is primarily to provide a secondary path to the amplifiers. If cables are broken or disconnected in either direction, all amplifiers still may be addressed by the network.

Q: How can I be sure that no protection circuits or safety functions interfere with the output signal?

A: If no Clip or Warning LEDs on the front panel light up, you can be fully confident that the rated maximum output power in the full frequency range is available for your speakers. No limiting or gain-reduction takes place without a warning or fault indication.

8.3 BENCH TEST THE AMPLIFIER

All Martin Audio amplifiers are highly advanced devices which incorporate various features (e.g. VHF protection and Power Average Limiter) that make it impossible to verify maximum performance when performing a standard bench-test with continuous, full-scale sine-wave signals.

We therefore highly recommend that you take the time to read our document: “Amplifier testing procedure”, found at www.martin-audio.com, before you bench-test a Martin Audio amplifier.

8.4 ADDITIONAL DOCUMENTATION

In case you didn't find what you were looking for in this Operation Manual, please visit www.martin-audio.com, where you can find a multitude of additional documentation for Q Series: Drawings, technical data sheets, tables with input sensitivity, background technology briefs and much more.

8.5 BTU SPECIFICATIONS

The following tables contain information on measured current consumption as well as calculated heat dissipation at three states: 1) Stand-by/idling; 2) Normal operation (1/8 of rated power); and 3) at extreme heavy duty operation (Max. power).

MA6.8Q									
Level	Load	Rated power	Line Current		Watt *1)			Thermal Dissipation	
			115VAC	230VAC	In	Out	Dissipated	BTU/hr	kCal/hr
Standby w. remote Power Off via NomadLink					0	0	0	0	0
Power On, Idling					133	0	133	454	114
			Amp (I) *2)		W				
1/8 of rated power (Pink noise, 12 dB crest factor)	8 Ω / Ch.	1200 x4	16,0	8,0	1123	600	523	1784	450
	4 Ω / Ch.	1700 x4	22,4	11,2	1578	850	728	2484	626
	2 Ω / Ch.	1200 x4	21,2	10,6	1378	600	778	2655	669
	100V / Ch.	1600 x4	21,0	10,5	1463	800	663	2262	570
Max. power*3) (Pink noise, 6dB crest factor)	8 Ω / Ch.	1200 x4	32,6	16,3	2429	1600	829	2829	713
	4 Ω / Ch.	1700 x4	38,8	19,4	2697	1700	997	3402	857
	4 Ω / Ch.	1200 x4	35,2	17,6	2296	1200	1096	3740	942
	100V / Ch.	1600 x4	35,4	17,7	2605	1600	1005	3429	864
Mains connector, 230 V CE version			16 A, CEE7						
Mains connector, 115 V ETL version			20 A / 5-20P						
*1) The amplifier's PSU operates as a non-resistive load, so the calculation "Volts x Amps = Watts" would not be correct. Instead, measured and specified here is what is known as the "Active Power" in the amplifier providing useful, real-world values of power consumption and heat dissipation.									
*2) Current draw figures measured at 230 V. 115 V figures are 230 V figures multiplied by two.									
*3) Figures measured at maximum power before amplifier protection and limiter features kicks in. Typically this is between 1/4 and 1/3 of rated power. Note that the max. power condition is very extreme and will never occur during normal operation. Also note that the mains breaker will not be tripped even if's in excess of max. ratings.									

MA4.8Q									
Level	Load	Rated power	Line Current		Watt *1)			Thermal Dissipation	
			115VAC	230VAC	In	Out	Dissipated	BTU/hr	kCal/hr
Standby w. remote Power Off via NomadLink					0	0	0	0	0
Power On, Idling					123	0	123	420	106
			Amp (I) *2)		W				
1/8 of rated power (Pink noise, 12 dB crest factor)	8 Ω / Ch.	1000 x4	13,8	6,9	945	500	445	1518	383
	4 Ω / Ch.	1200 x4	17,4	8,7	1171	600	571	1948	491
	2 Ω / Ch.	600 x4	12,4	6,2	769	300	469	1600	403
	100V / Ch.	900 x4	13,2	6,6	840	450	390	1331	335
Max. power*3) (Pink noise, 6dB crest factor)	8 Ω / Ch.	1000 x4	28,2	14,1	2116	1333	783	2670	673
	4 Ω / Ch.	1200 x4	30,6	15,3	2168	1200	968	3303	832
	2 Ω / Ch.	600 x4	21,6	10,8	1368	600	768	2620	660
	100V / Ch.	900 x4	26,4	13,2	1827	1200	627	2139	539
Mains connector, 230 V CE version			16 A, CEE7						
Mains connector, 115 V ETL version			20 A / 5-20P						
*1) The amplifier's PSU operates as a non-resistive load, so the calculation "Volts x Amps = Watts" would not be correct. Instead, measured and specified here is what is known as the "Active Power" in the amplifier providing useful, real-world values of power consumption and heat dissipation.									
*2) Current draw figures measured at 230V. 115V figures are 230V figures multiplied by two.									
*3) Figures measured at maximum power before amplifier protection and limiter features kicks in. Typically this is between 1/4 and 1/3 of rated power. Note that the max. power condition is very extreme and will never occur during normal operation. Also note that the mains breaker will not be tripped even if it's in excess of max. ratings.									

9. TECHNICAL SPECIFICATIONS

Following are the Q Series technical specifications. These figures are accurate at the time of printing but please note that all figures are subject to change without notice. For the most accurate and current information available, please visit www.martin-audio.com.

Individual values for Q Series amplifiers

	MA6.8Q	MA4.8Q
Number of channels per amplifier	4	4
Total Power Limit	6800 W	4800 W
Max. output voltage per channel	100 V _{rms}	100 V _{rms}
Max. output current per channel	24.5 A _{rms}	17.5 A _{rms}
Max. continuous output power all 4 channels driven at VPL: 141V and Gain: 35dB		
16 ohms (per ch.)	650 W	625 W
8 ohms (per ch.)	1200 W	1000 W
4 ohms (per ch.)	1700 W	1200 W
Hi-Z: 70V/100V (per ch.)	1600 W	900 W
Mains connector, 230V CE version	16A / CEE7	16A / CEE7
Mains connector, 115V ETL version	20 A / 5-20P	20 A / 5-20P
Maximum mains current consumption, 230V version	11.2 A	8.7 A
Maximum mains current consumption, 115V version	22.4 A	17.4 A
Performance with Gain: 35dB and VPL: 141V		
THD 20 Hz - 20kHz for 1W	0.1%	0.1%
THD at 1kHz and 1dB below clipping	0.05%	0.05%
Signal To Noise Ratio	112 dBA	112 dBA
Channel separation (Crosstalk) at 1kHz	70 dB	70 dB
Frequency response (1 W into 8 Ohm) +0/-3dB	6.8 Hz - 34 kHz	6.8 Hz - 34 kHz
Voltage Peak Limiter (VPL), max. peak output		
VPL, selectable per channel. (V) ³⁾	141, 118, 100, 85, 71, 59, 50, 42 V	
Voltage Peak Limiter mode (per ch.)	Hard / Soft	Hard / Soft
Gain and level		
Amplifier gain selectable (all channels) ¹⁾	Rear panel switches: 23, 26, 29, 32, 35, 38, 41, 44 dB	
Default gain	32dB	
Level adjustment (per ch.)	Front panel pot, 21 position detent -inf to 0 dB, hidden behind security panel/dust filter grille	
General		
Input connectors (per ch.)	3-pin Phoenix, electronically balanced	
Output connectors (per ch.)	Barrier strip 2-pole screw terminals	
NomadLink network	On board, 2 x RJ45 EtherCon connectors, IN and OUT	
Intelligent fans (on/off)	Depending on presence of output signal	
Power on/off and Remote enable on/off	Individual switches on front panel	
Cooling	Two fans, front to back airflow, temperature controlled speed	
Front panel indicators:		

Common	NomadLink® Network; Power Average Limiter (PAL™) 2); Power on
Per channel	Signal present / High impedance; -10 dB and -4 dB output signal; Voltage Peak Limiter (VPL); Current Peak Limiter (CPL): Very High Frequency (VHF); High temperature; Fault; Mute
Operating voltage, 230 V / 115 V nominal ⁵⁾	130-265 V / 65-135 V
Minimum power-up voltage, 230 V / 115 V	171 V / 85 V
Power Average Limiter ²⁾	Yes
Soft start / Inrush power	Yes / max. 5A
Dimensions (W/H/D)	W: 483 mm (19"), H: 88 mm (2 U), D: 343 mm (13.5")
Weight	12 kg (26.4 lbs.)
Finish	Black painted steel chassis with grey painted steel front
Approvals	CE 230V, ETL 115V/230V, FCC

PAL™ reduces the maximum output power keeping the power supply in safe operating area and/or preventing excessive current draw tripping the mains breaker. Refer to user's manual.

The Voltage Peak output values translate to rms Voltage for a sine wave as: $peak/1.41 = V_{rms}$. E.g. 141V peak is 100Vrms and 100V peak is 70Vrms. This means that the outputs can be set for high impedance loads without the use of an external transformer.

Single channel operation at 2 ohms and bridged mode at 4 ohms are not recommended.

Separate 230 V or 115 V versions available. Not selectable on the amplifier.

10. WARRANTY

General

This product is manufactured by Martin Audio, and it is warranted to be free from any defects caused by components or factory workmanship, under normal use and service, for a period of two (2) years from date of purchase from an authorized Martin Audio dealer.

If the product fails to perform as specified during the warranty period, Martin Audio will undertake to repair, or at its option, replace this product at no charge to its owner, provided the unit is returned undamaged, shipping prepaid, to an authorized service facility or to the factory.

This warranty shall be null and void if the product is subjected to: repair work or alteration by a person other than those authorized by us; mechanical damage including shipping accidents; war, civil insurrection, misuse, abuse, operation with incorrect AC voltage, incorrect connections or accessories; operation with faulty associated equipment; or exposure to inclement weather conditions. Damage due to normal wear and tear is not covered by the warranty. Units on which the serial number has been removed or defaced will not be eligible for warranty service.

Martin Audio shall not be responsible for any incidental or consequential damages. **Martin Audio's** responsibility is limited to the product itself. **Martin Audio** takes no responsibility for any loss due to cancellation of any events, or rent of replacement equipment or costs due to a third parties or customer's loss of profit, or any other indirect cost or losses however incurred. Martin Audio reserves the right to make changes or improvements in design or manufacturing without assuming any obligation to change or improve products previously manufactured.

This warranty is exclusive, and no other warranty is expressed or implied. This warranty does not affect the customer's statutory rights.

International warranties

Please contact your supplier or distributor for this information, as rights and disclaimers may vary from country to country.

Technical assistance and service

International

If your Martin Audio product requires repair, visit www.martin-audio.com, contact your Martin Audio dealer or distributor, or contact Martin Audio by fax or email to obtain the location of the nearest authorized dealer or distributor.

Factory service

In the event Martin Audio product requires factory service, you may contact your Martin Audio dealer for return instructions.

Please note for product return:

Use the original packing.

Include a copy of the sales receipt, your name; return address, phone and fax number, email address and description of the defect.

Martin Audio Limited
Century Point, Halifax Road
Cressex Business Park, High Wycombe
Buckinghamshire, UK. HP12 3SL

Phone: +44 (0)1494 535312

Fax: +44 (0)1494 438669

info@martin-audio.com

www.martin-audio.com