

Martin Audio

Section 5

W8L Series Line Arrays

**W8L Longbow, W8LC and W8LM
with advice on subwoofer
and front-fill alignment**

Includes W8LD, W8LCD & W8LMD



The Martin Experience

Section 5

Application Guide

**Wavefront W8L Series Line Arrays
W8L Longbow, W8LC & W8LM
with
Advice on subwoofer and front-fill alignment**

**Click blue text then scroll down for separate spreadsheets for
W8LD, W8LCD & W8LMD down-fill controller settings & notes**

- 5.1 [Introduction](#)**
- 5.2 [Specifications, outline drawings and performance plots](#)**
- 5.3 [Line array behaviour](#)**
- 5.4 [How many do I need?](#)**
- 5.5 [ViewPoint™ and System control](#)**
- 5.6 [Horizontal considerations](#)**
- 5.7 [Subwoofers and Front Fills](#)**
- 5.8 [Climatic effects](#)**
- 5.9 [Delay Systems](#)**
- 5.10 [W8L Longbow Quick Start Guide \(including W8LD patch examples\)](#)**
- 5.11 [W8LC Quick Start Guide \(including W8LCD patch examples\)](#)**
- 5.12 [W8LM Quick Start Guide \(includes W8LMD patch examples\)](#)**

General information

W8L Series Applications Guide, Version 3, December 2006

Copyright by Martin Audio Ltd 2006; all rights reserved.

Martin Audio Ltd

Century Point, Halifax Road, Cressex Business Park, High Wycombe, Buckinghamshire. UK.

The information presented in this document is, to the best of our knowledge, correct. Martin Audio Limited will not, however, be held responsible for the consequences of any errors or omissions.

Technical specifications, weights and dimensions should always be confirmed with Martin Audio Limited before inclusion in any additional documentation. In our efforts to develop and improve our products we reserve the right to change the technical specification of our products without notice. Martin Audio Limited tries, whenever possible, to minimise the effects of product changes on equipment compatibility.

Wavefront W8L Series Line Arrays



5.1 Introduction

Martin Audio W8L Series line arrays are next generation line array systems which combine innovative loudspeaker design techniques with line array technology to produce a family of very powerful line arrays with extended frequency response, smooth coverage and maximum dynamic impact.

The series includes:

- ✚ The W8L Longbow 3-way full-range line array + W8LD down-fills
- ✚ The W8LC 3-way compact line array + W8LCD down-fills
- ✚ The W8LM 3-way mini line array + W8LMD down-fills

W8L Longbow, W8LD, W8LC & W8LCD systems are fully horn-loaded tri-amplified systems. All sections are 8 ohms for easy paralleling in pairs.

W8LM & W8LMD systems combine direct radiating and horn-loaded cone drivers for low and mid frequency coverage with a horn-loaded high frequency section. The system may be bi-amplified (low/mid & high) or driven using a single amplifier channel via its internal 3-way passive crossover. W8LMs & W8LMDs are 12 ohms for easy paralleling in threes or fours.

Where low frequency extension is required, W8L Series line arrays will integrate

with a range of Martin Audio subwoofers including the W8LS direct radiating subwoofer system or Martin Audio WLX and WMX Hybrid™ subwoofer systems. See [section 5.7](#) for further details on the WLX.

W8L Longbow, W8LC and W8LM systems combine patentable driver loading techniques - researched and proven by Martin Audio over many years - with no-compromise vertically-coupled waveguides and true constant directivity horns to achieve a level of efficiency and coverage consistency not usually found in this popular format. W8L Series horns develop low curvature vertical wavefronts for smooth, comb-free coupling at practical vertical splay angles. A feature not possible with spaced, point-source drivers.

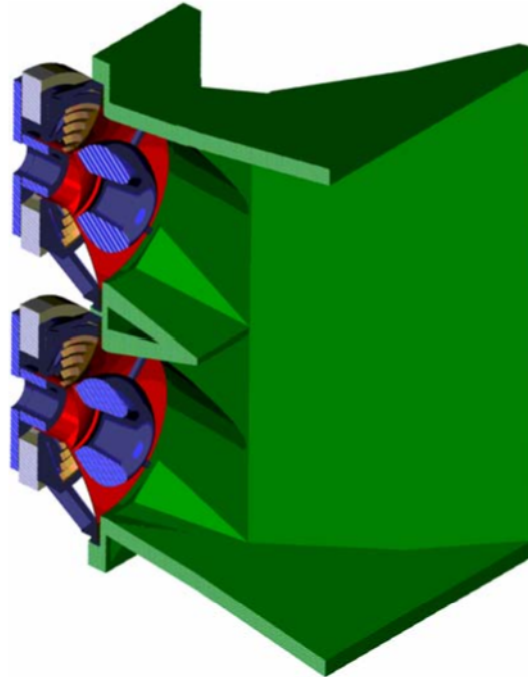

W8L Longbow Midrange section

Wavefront W8L Series line arrays feature integral, quick deployment flyware systems which allow progressive curvature columns of up to 16 cabinets to be assembled. By hinging at the front rather than the rear, the rigging system minimises gaps between the acoustic elements which would otherwise interfere with the line array effect.

Viewed from the side, W8L Series enclosures are trapezoidal in shape with 3.75° wall angles to allow arrays of varying curvature to be constructed. A series of inter-cabinet splay angles from 0° to 7.5° are selected by links at the rear of the enclosure. The 7.5° maximum splay angle allows tight curvature at the bottom of the array. 20° W8L Series down-fill systems are also available ([click here for more information](#)).



W8L Longbow rear rigging

Caution:

W8L Series systems should be rigged and flown by professional riggers or trained personnel under professional riggers' supervision. Flying professional loudspeaker systems is not a job for amateurs!

See the appropriate Flying System User Manual for further details.

5.2 W8L Longbow, W8LC & W8LM single enclosure specs

(For further details, down-fill specs etc., go to www.martin-audio.com)

Specification	W8L Longbow	W8LC	W8LM
Type	Full-range 3-way line array element	Compact 3-way line array element	Ultra-compact 3-way line array element
Frequency Resp ($\pm 3\text{dB}$)	35Hz-18KHz	60Hz-18KHz	60Hz-18KHz
Hor Coverage (-6dB) (-10dB)	90deg 120deg	90deg 120deg	100deg 120deg
Vert Coverage (-6dB)	7.5deg	7.5deg	7.5deg
Driver complement	LF: 1 x 15" Hybrid tm horn-loaded cone drivers MF: 2 x 8" horn-loaded cone drivers HF: 4 x 1" horn-loaded compression drivers	LF: 1 x 12" Hybrid tm horn-loaded cone drivers MF: 2 x 6.5" horn-loaded cone drivers HF: 3 x 1" horn-loaded compression drivers	LF+MF: 2 x 8" cone drivers. 1 ported direct radiating LF, 1 Hybrid tm horn-loaded LF/MF. HF: 2 x 1" horn-loaded compression drivers
Rated Power	LF: 1000W AES, 4000W peak MF: 400W AES, 1600W peak HF 200W AES, 800W peak	LF: 400W AES, 1600W peak MF: 200W AES, 800W peak HF 100W AES, 400W peak	Bi-amplified LF+MF: 400W AES, 1600W peak HF: 75W AES, 300W peak Passive 400W AES, 1600W peak
Sensitivity (spl at 1m, 1W)	LF: 106dB MF: 109dB HF: 119dB	LF: 103dB MF: 106dB HF: 109dB	Bi-amplified LF+MF: 100dB HF: 106dB Passive 99dB LF rising to 105dB HF
Max SPL (spl calc 1m)	LF: 136dB cont., 142dB peak.	LF: 129dB cont., 135dB peak.	Bi-amplified LF+MF: 125dB cont., 131 dB peak.

	MF: 135dB cont., 141dB peak. HF: 142dB cont. 148dB peak.	MF: 129dB cont., 135dB peak. HF: 129dB cont. 135dB peak.	HF: 125dB cont., 131 dB peak. Passive 124dB cont. 130dB peak.
Nominal Impedance	LF: 8 ohms MF: 8 ohms HF: 8 ohms	LF: 8 ohms MF: 8 ohms HF: 8 ohms	Bi-amplified LF+MF: 12 ohms HF: 12 ohms Passive 12 ohms
Crossover	LF to MF: 220Hz active, MF to HF 2.7KHz active	LF to MF: 300Hz active, MF to HF 3KHz active	LF to MF: 300Hz passive, MF to HF 2.2KHz active or passive
Connectors	2 x Neutrik NL8 or PAcon sockets (Input & Link)	2 x Neutrik NL8 or PAcon sockets (Input & Link)	2 x Neutrik NL4 sockets (Input & Link)
Enclosure	Vertical trapezoid 3.75 deg top & bottom walls. Multi-laminate birch ply	Vertical trapezoid 3.75 deg top & bottom walls. Multi-laminate birch ply	Vertical trapezoid 3.75 deg top & bottom walls. Multi-laminate birch ply
Finish	Textured paint	Textured paint	Textured paint
Grille	Perforated steel	Perforated steel	Perforated steel
Dimensions	mm (W) 1314 (H) 490 (D) 755/855*	(W) 1000 (H) 367 (D) 550/683*	(W) 620 (H) 241 (D) 400
	inches (W) 51.7 (H) 19.3 (D)29.7/33.7*	(W) 39.4 (H) 14.5 (D) 21.7/26.9*	(W) 24.4 (H) 9.5 (D) 15.75
(*incl wheelboard)			
Weight (incl. steel hardware)	120Kg (264lbs)	58Kg (1 28lbs)	24Kg (53lbs)

W8L Longbow & W8LS outline dimensions (W8LS shown)

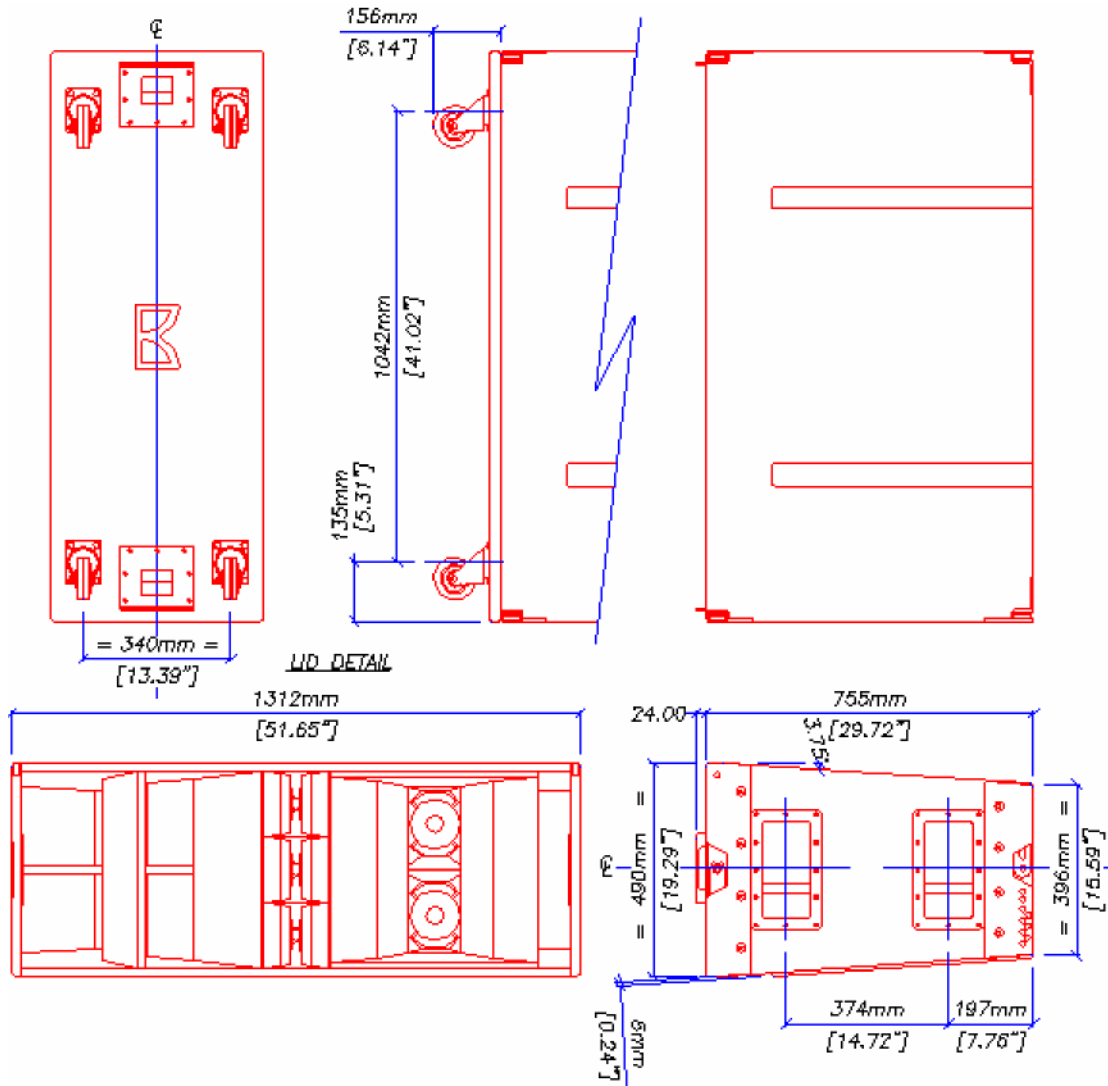

W8LC outline dimensions

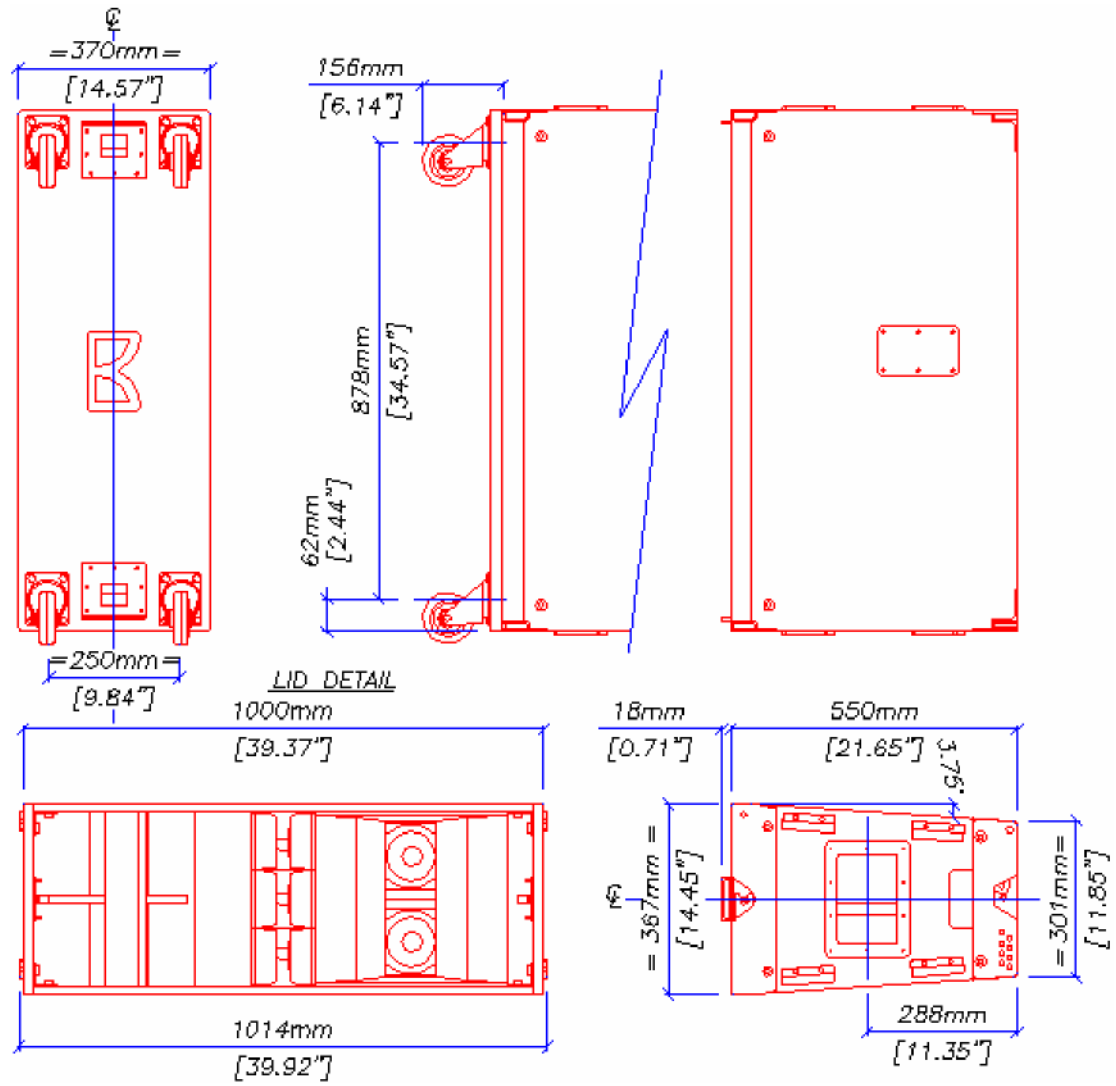

W8LM outline dimensions

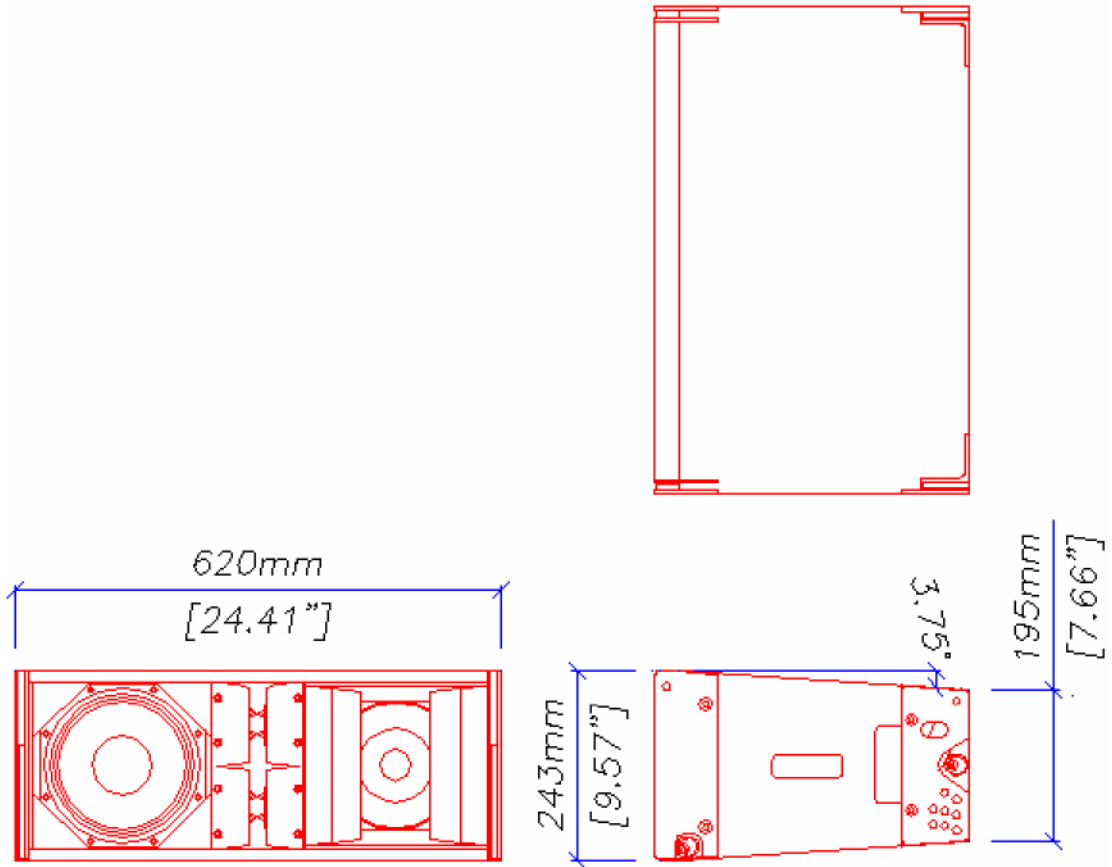

WLX outline dimensions

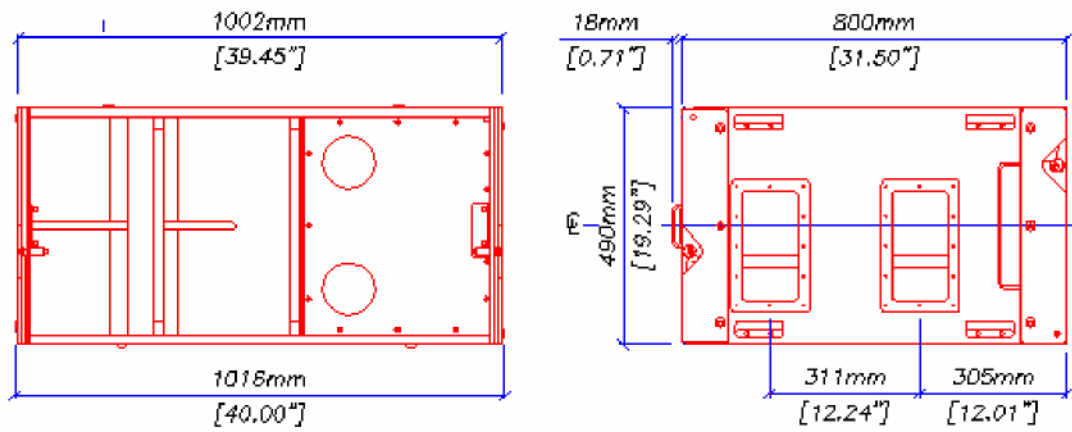
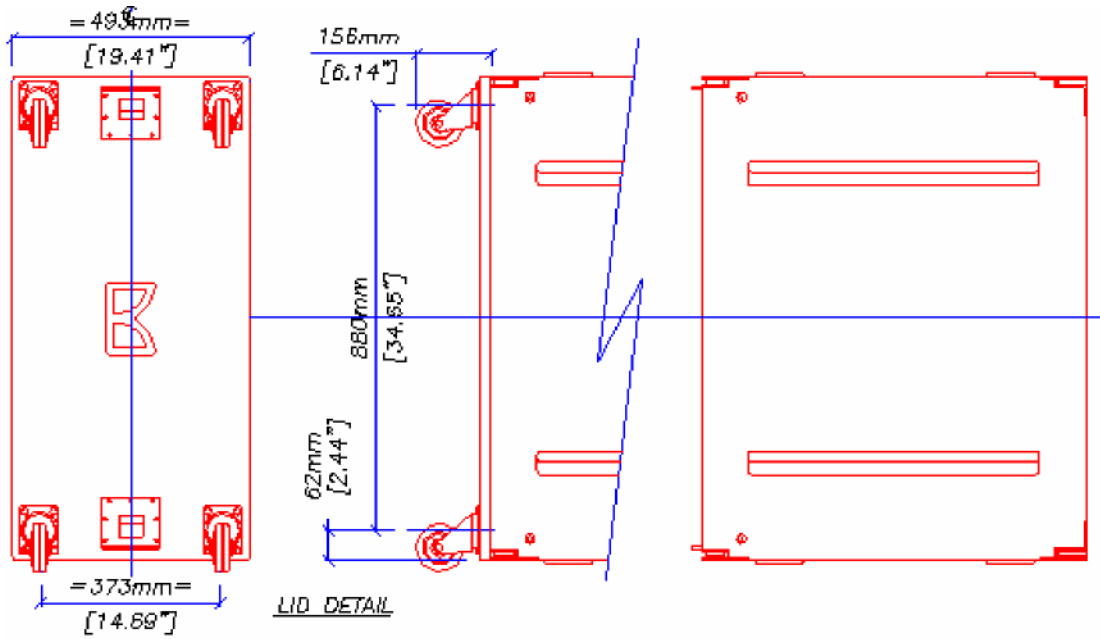

Horizontal polar responses

(Vertical response are 7.5deg line functions for W8L, W8LC & W8LM and 20deg line function for W8LD, W8LCD & W8LMD)

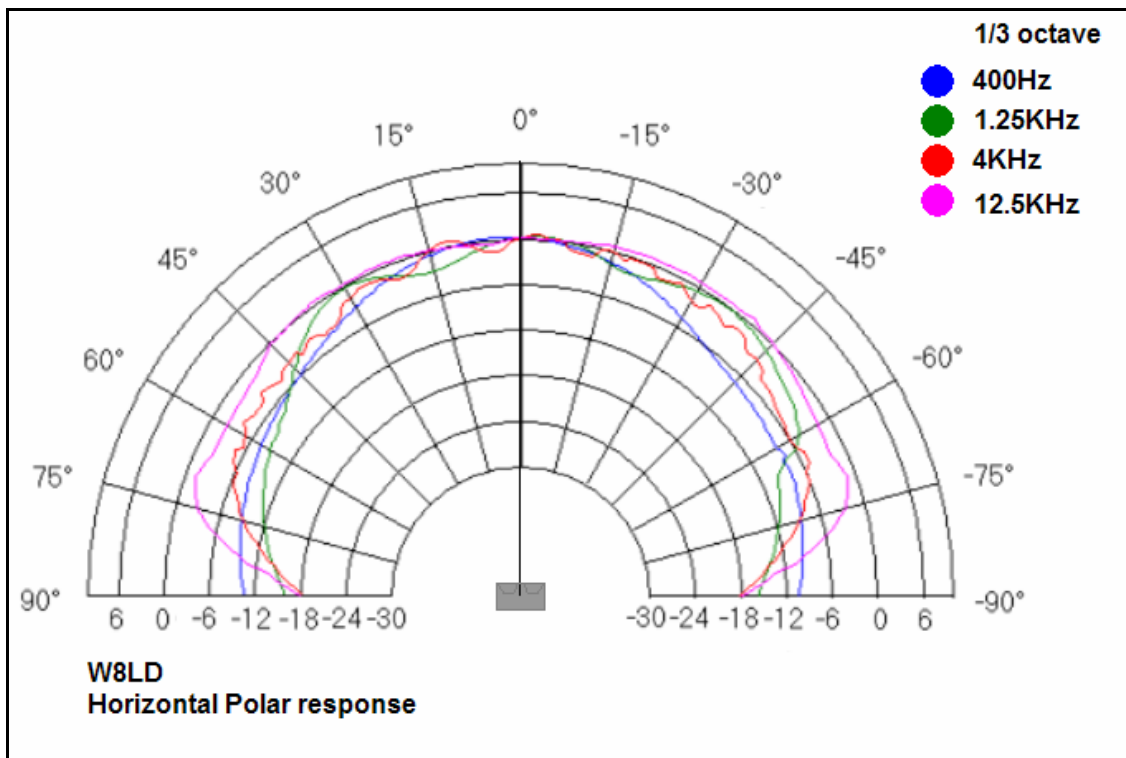
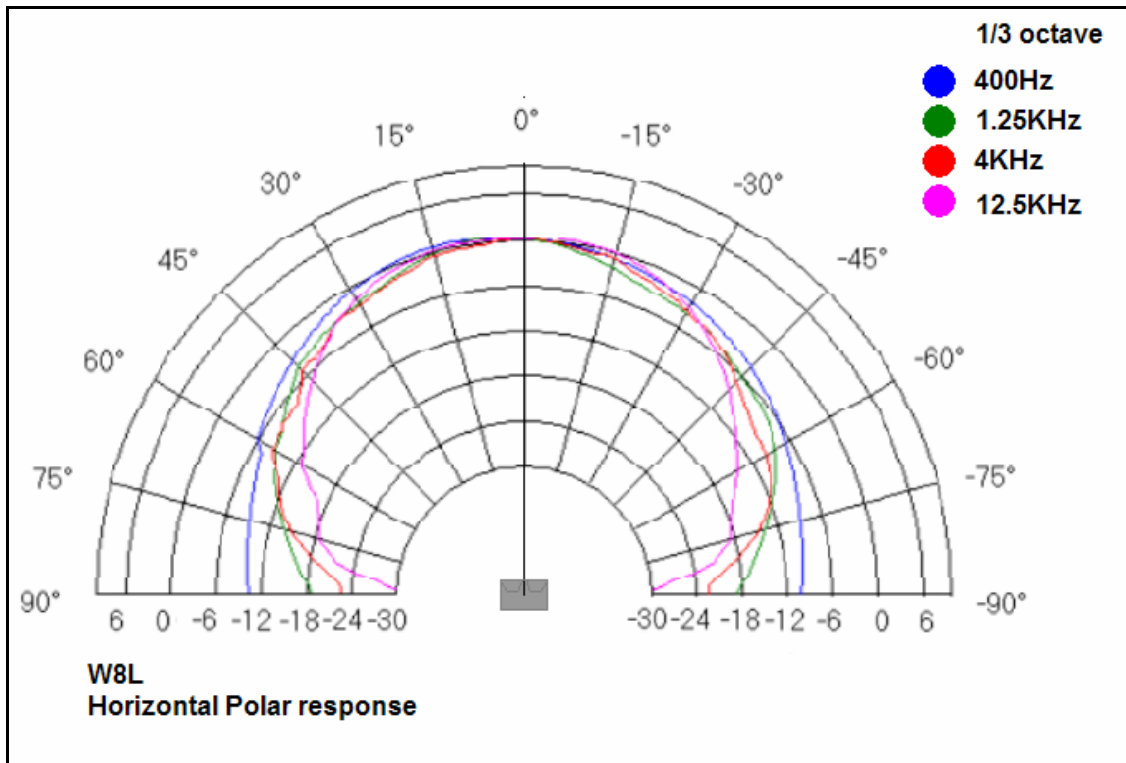

For further W8LD details, go to www.martin-audio.com

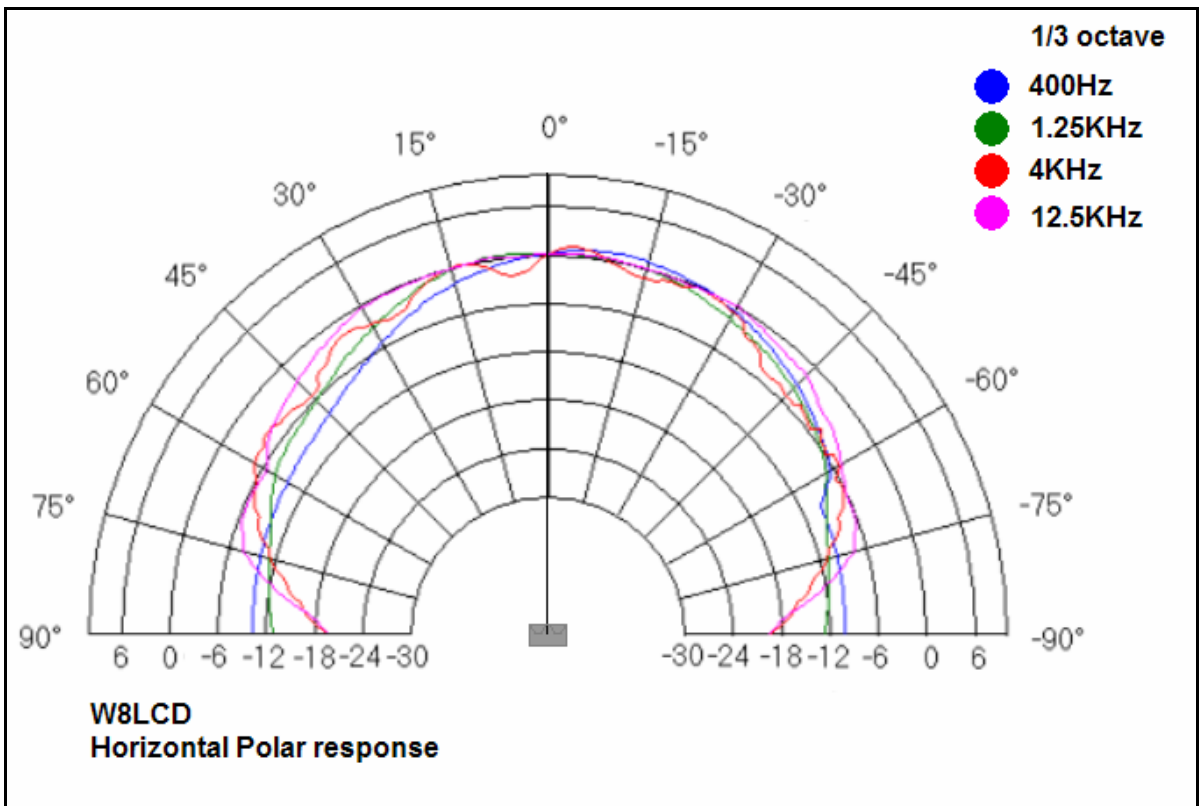
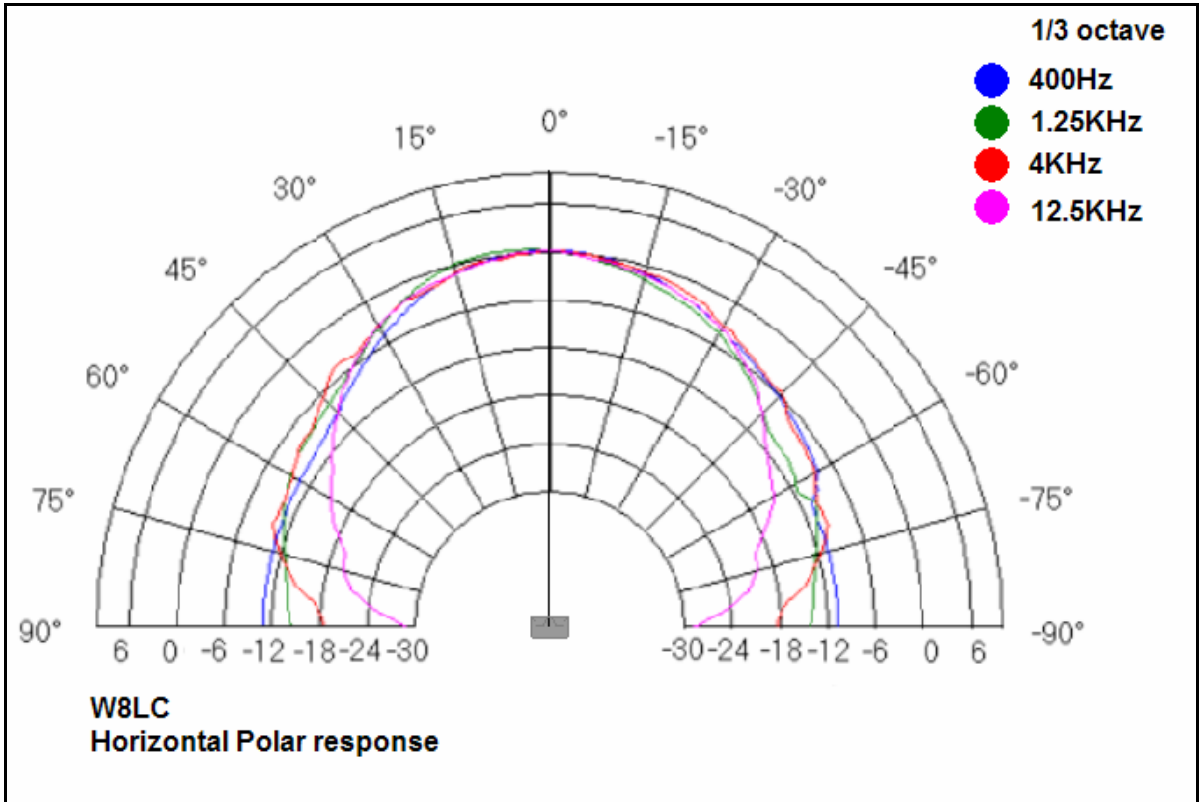

For further W8LCD details, go to www.martin-audio.com

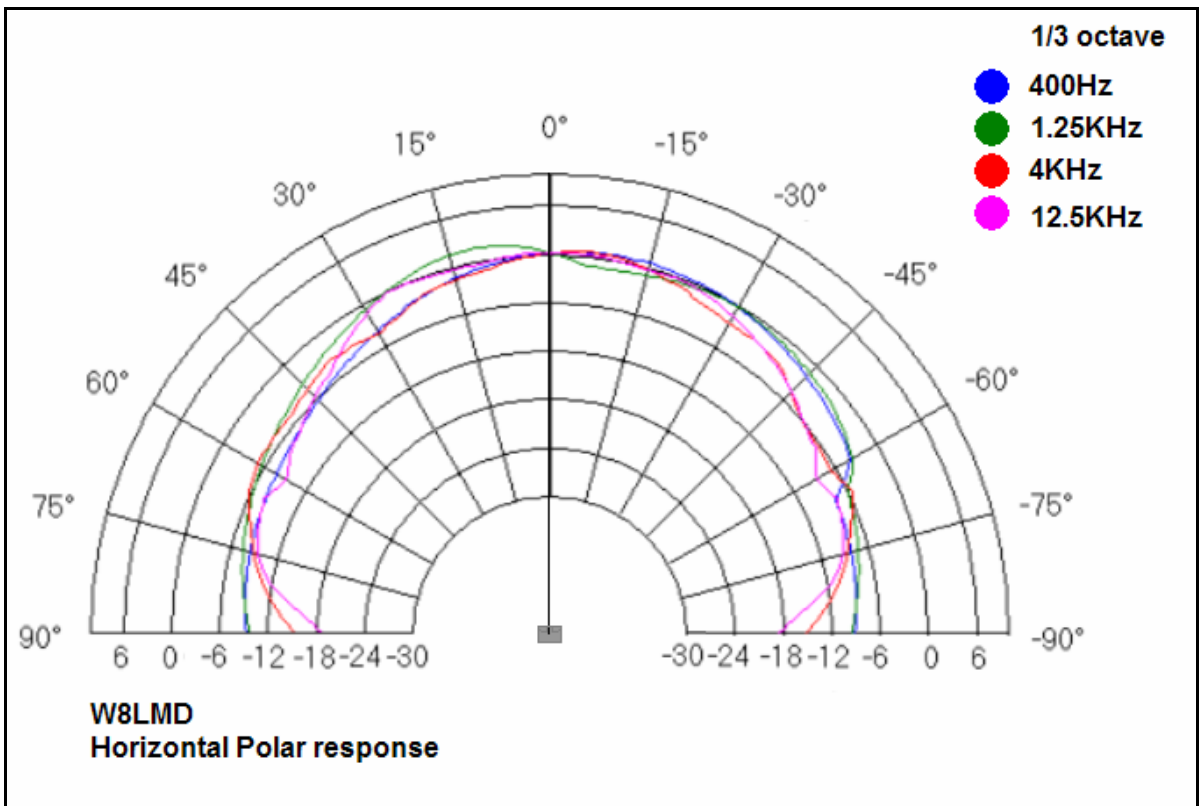
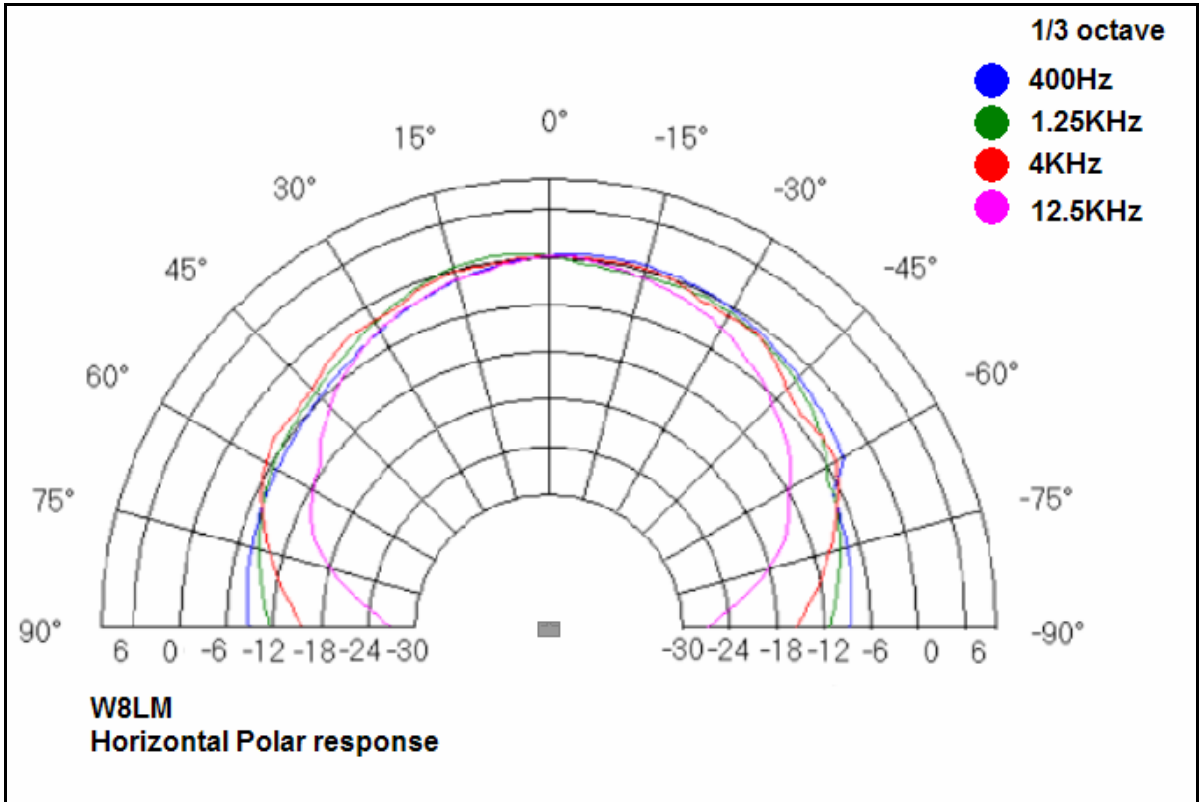

For further W8LMD details, go to www.martin-audio.com

5.3 Line array behaviour

Although the vertical coverage of a single point source may be wide, when arrayed in a straight line, multiple, acoustically small sources vector sum to form a tighter vertical coverage pattern that narrows with increasing cluster height and frequency following the classic law for multiple source line arrays.

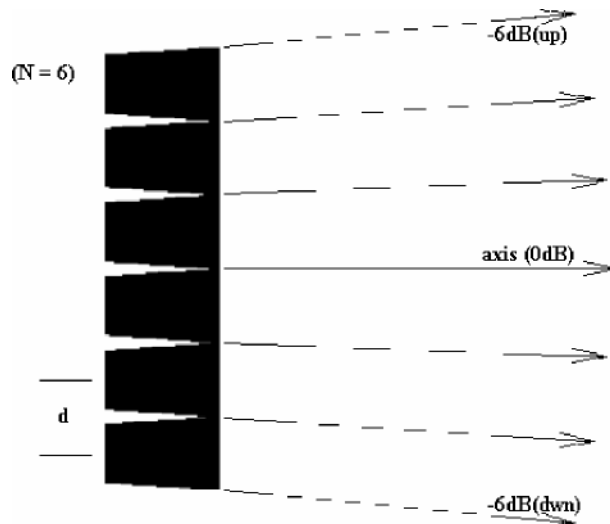

$$\text{Main coverage angle} = 2 \times \arcsin \left(\frac{0.61\lambda}{Nd} \right)$$

(between -6dB points
either side of axis)

where λ = the sound wavelength in meters = $\frac{340^*}{\text{Frequency (Hz)}}$
 N = the number of W8Ls high
 d = the centre-to-centre spacing (= 0.49m if vertically tightpacked)

* = speed of sound (m/s).Varies with temp.
 Arcsin = "the angle whose sin is..."
 Nd = the total height of the column in meters

Stacked general purpose horns vs low curvature line array elements

Note that individual elements have to be closely spaced to develop the benefits of a line array. Stacking traditional, vertically formatted multi-driver cabinets (with, typically, an LF driver near the bottom of the cabinet and an HF driver or horn near the top) simply doesn't work.

The following illustrations compare the poor coverage characteristics of vertically stacked general purpose loudspeakers with properly designed, closely coupled line arrays elements.

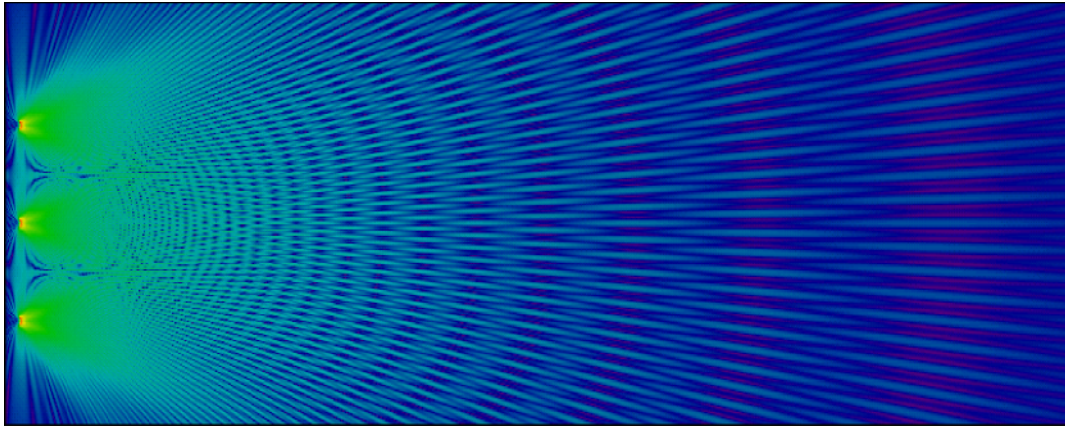

Three 30° horns 1m apart, 8kHz

The vertically spaced HF horns will have hot spots directly in front of each horn. The outputs from these multiple elements will add or subtract in the mid and far field depending on the wavelength and relative propagation times.

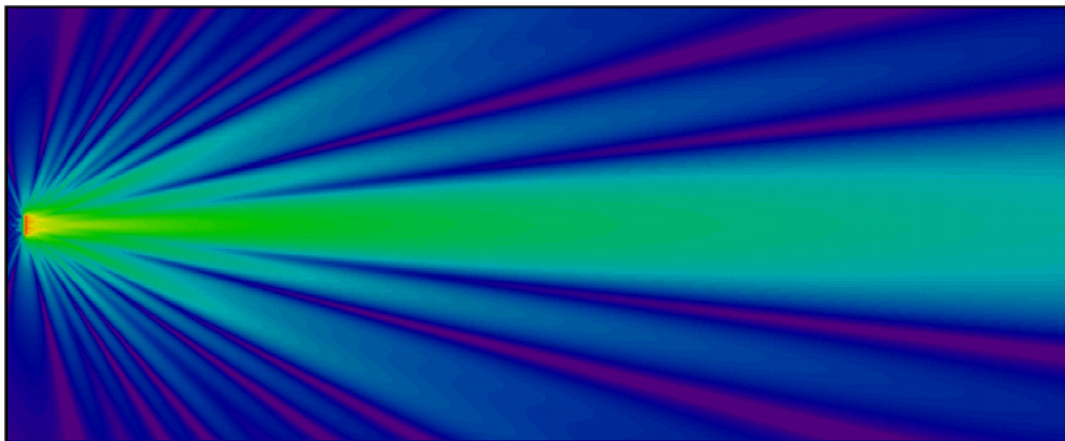

Three tightly arrayed low curvature horns at 8kHz

Closely spaced elements will sum more coherently.

As the number of coherent elements is increased forward projection strengthens and the side lobes decrease.

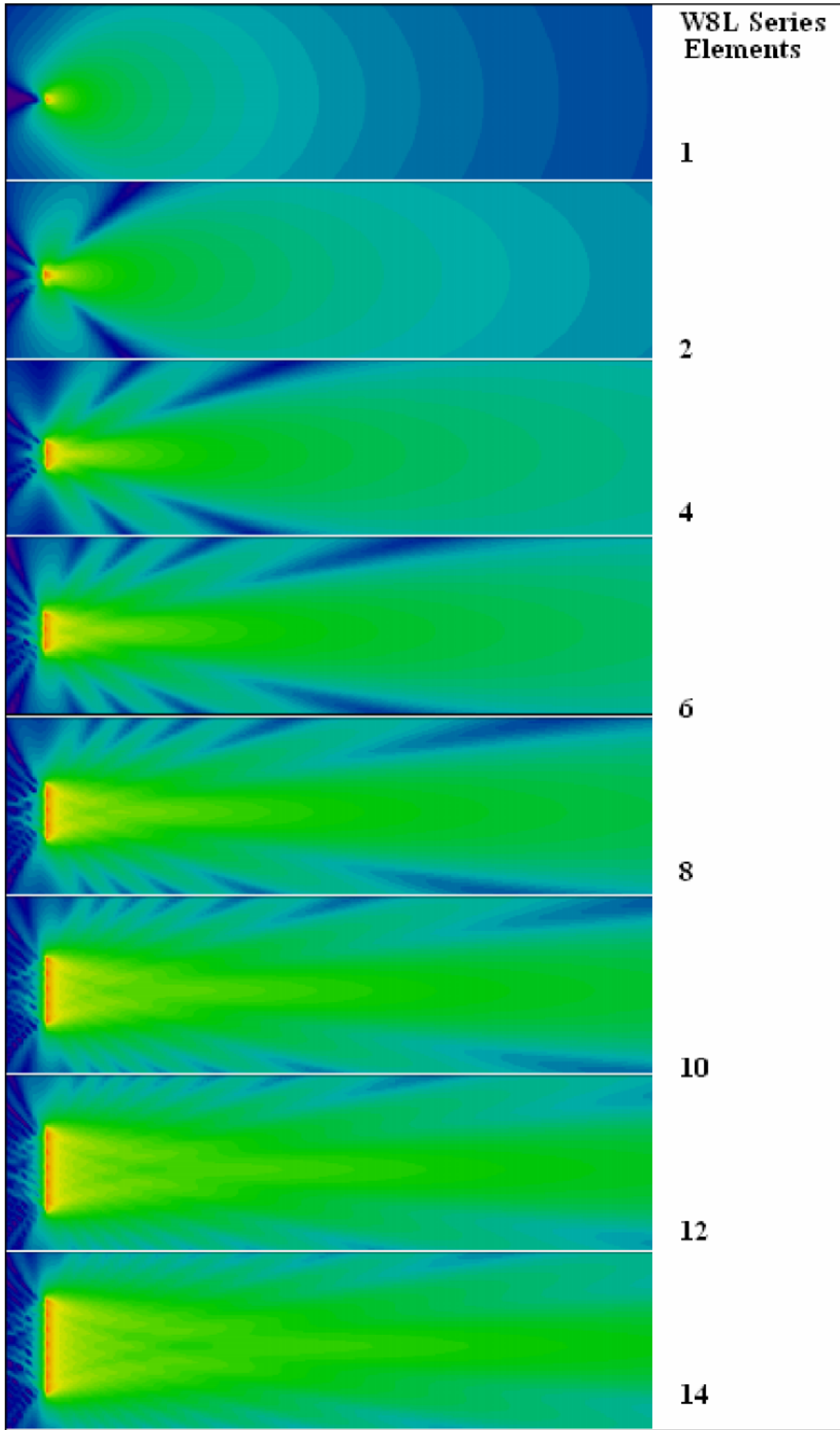

Unfortunately, the line array effect can also be limited by other factors:

- Real-world arrays tend to be acoustically small at low frequencies – restricting the low attenuation region to just a few metres
- Air absorption can cause excess attenuation of high frequencies and can be a significant factor over medium to long distances as it has a linear dB characteristic with distance (i.e. it may be quantified in dB/m)
- Coupling between adjacent elements can be imperfect at high frequencies because cabinet to cabinet spacing is significant at very short wavelengths. This is minimised for W8L Series systems by placing the cabinet-to-cabinet hinge at the front.

W8L Series

Note that our mid and hf designs do not try to emulate a dead straight ribbon. Practical loudspeaker columns must have vertical coverage patterns tailored to suit the audience size and shape and our line array systems have been designed with this in mind. The W8L Series are deliberately designed to produce slightly curved vertical wavefronts - enough to allow up to 7.5° of vertical splay to be introduced between boxes but not enough to affect straight line performance.

Curved arrays – determining inter-cabinet splay angles

Straight columns (0° splay angles) produce far-field high-mid frequency sound pressure levels that increase approximately 6dB for every doubling of W8L quantities but, as inter-box splay angles increase, the vector sum of multiple W8Ls decreases through 3dB for a 3° splay to 0dB (no summation) at 7.5° . This *Progressive Curvature* provides smooth level coverage without amplifier channel trimming for most applications.

ViewPoint™ and DISPLAY™ software

Martin Audio's ViewPoint and DISPLAY software calculates the optimum progressive curvature for a given audience area. The progressive curvature produces a more consistent frequency response from the front rows to the rear seats than the commonly used J-shaped arrays that have a straight, long throw section at the top and a curved lower section. An over-angular J-shaped array acts like a foreshortened straight array above a point source array and creates vertical lobes that result in irregular coverage.

ViewPoint calculates the maximum summation point (near the top of a progressively curved array) and aims this towards the furthest listening area. A progressive curvature array's HF coverage weakens dramatically above the maximum summation point so this point is regarded as the Coverage Stop.

ViewPoint simply advises on the appropriate array geometry and controller presets for a given 2-D room geometry. DISPLAY™ operates may be used in 2-D or 3-D and predicts polar responses, coverage levels and frequency responses.

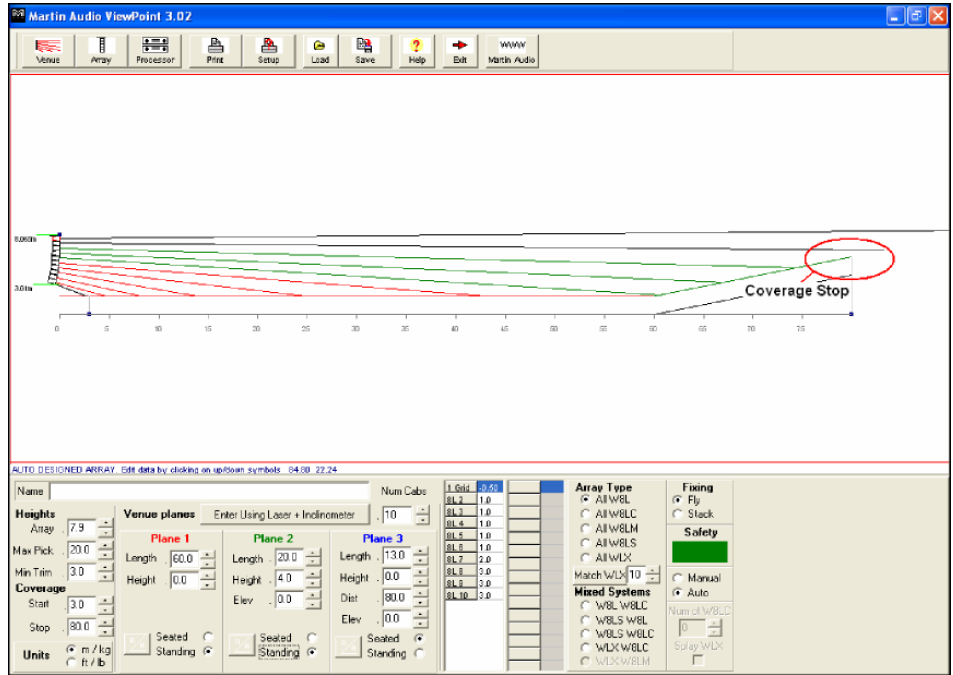

Coverage stop

A J-shaped array will provide irregular coverage in the near-field and mid-field audience areas due to imperfect summation of the very straight line top section and the spherical lower section.

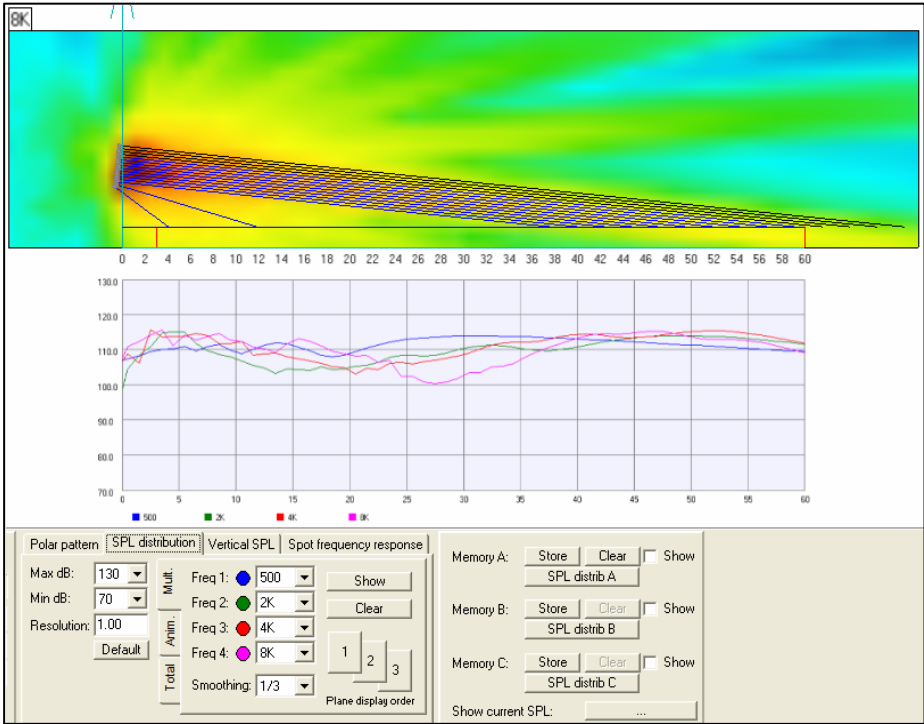

Irregular coverage from a J-shaped Array (including down-fills) – DISPLAY™ simulation

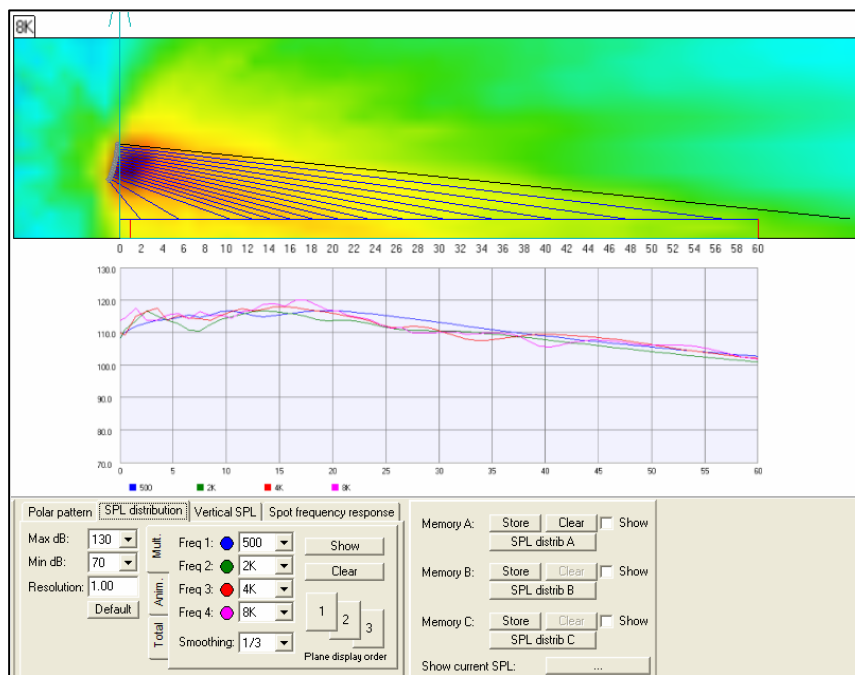

**Irregular coverage from an over-curved array (including down-fills)
– DISPLAY™ simulation**

An over-curved array will tend to cause weak coverage in the far-field.

It is possible to create a remarkably flat level response with distance using the appropriate combination of progressive curvature, level control and equalisation.

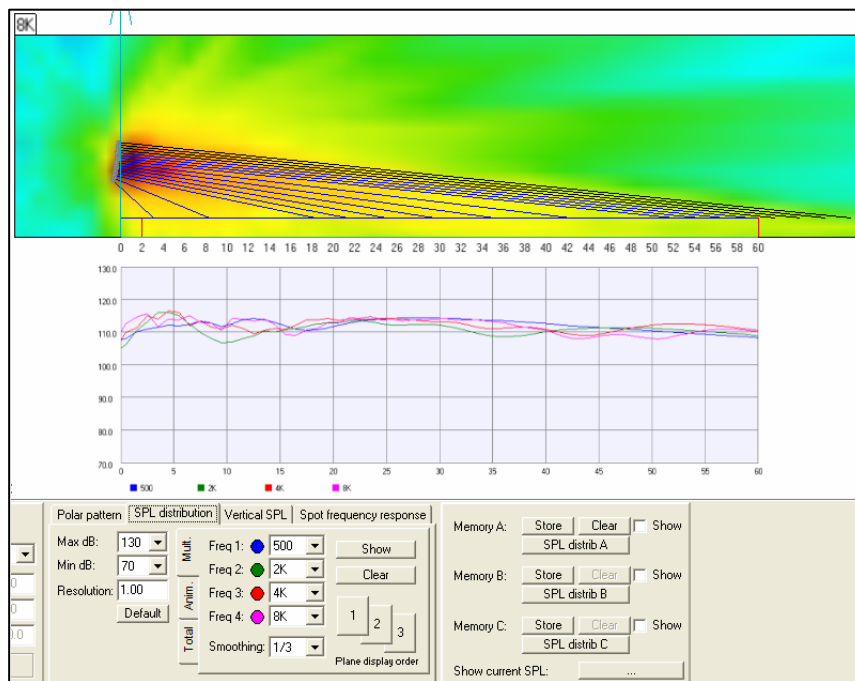

**14xW8LM+2xW8LMD set for almost flat level response –
DISPLAY™ simulation**

Whilst the above response may look good on a plot, the response in the near-field is a bit ragged and subjective experience dictates that a slight decrease in level with distance is desirable. A system with, say, +4dB at the front smoothly decreasing to -4dB at the back will sound more natural as long as background noise is not problematic.

The following progressive curvature array has a more natural coverage characteristic.

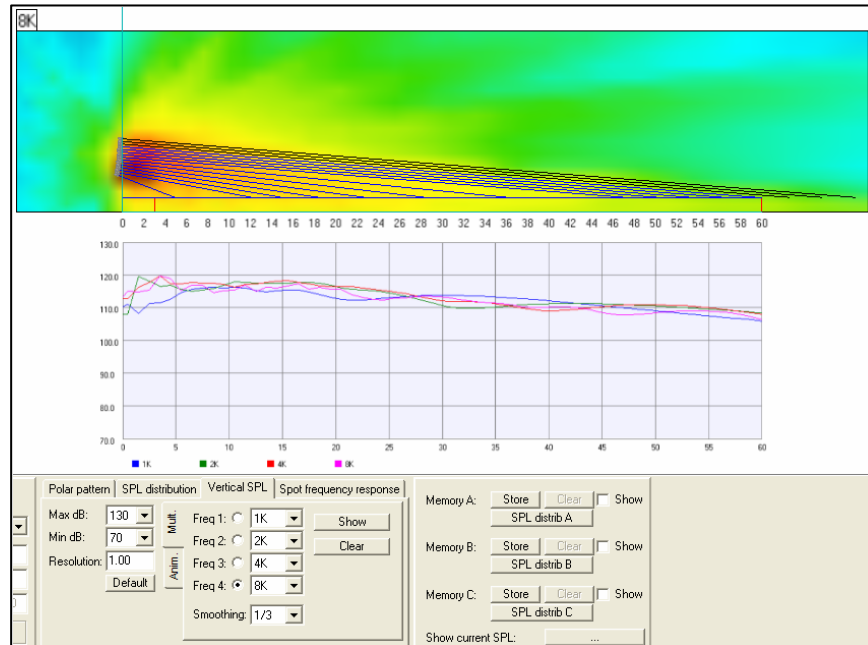

Smoother coverage from a progressive curvature array (including down-fills) – DISPLAY™ simulation

Band-zoning

Air absorption can cause excess high frequency attenuation which can seriously limit far-field performance unless compensation is used. Air absorption is most serious around 20% RH (relative humidity) – although the effect varies with temperature and atmospheric pressure.

Mid and high frequency boost are applied to the upper sections of an array to compensate for air losses. Again, a completely flat level and amplitude response will sound unnatural in the far-field. As mentioned earlier, an acceptable overall level range is ± 4 dB. An acceptable amplitude response is between flat and slightly pink (a falling response with frequency by up to 0.8dB per octave).

For more information on band-zoning, see the information on [System control](#) or the relevant [W8L Longbow](#), [W8LC](#) or [W8LM](#) quick start section.

5.4 How many do I need?

There are four major factors to be taken into account when determining what model of line array to use and how many:

- Will I need delays? This is very important – see [section 5.9](#)
- Spectral balance – the minimum column length required for spectral balance over the complete audience distance – or just beyond the first delays
- Maximum spl – the number and model required to achieve maximum spl
- Horizontal coverage – see [section 5.6](#)

Spectral Balance

Users new to line array technology can be confused by the spectral balance requirement because they are used to thinking in power terms only.

A straight line array's transition distance tends to increase with line length and frequency. If we simplify the relationship between transition distance, length and frequency (by assuming that individual elements are omni-directional - which they tend to be at very low frequencies) we can use an industry-standard equation to estimate the effect of line length on the low frequency transition distance:

$$\text{Transition distance} = \frac{\text{line length}^2 \times \text{frequency}}{2 \times \text{speed of sound}}$$

The transition distance is proportional to the square of the line length. Reducing the line length by approximately 30% (which would only reduce headroom by 3dB with non-line array systems) will reduce the LF transition distance by 50%!

The minimum column length cannot be reduced simply because the band is a quiet traditional folk combo. A short line array column would project only mid frequencies to the far field. It would lack warmth and sparkle as it would not be long enough for the line affect to take effect at low mid frequencies and may not have the headroom at high frequencies. Boosting the system's LF and HF would simply cause too much bass in the front seats and a lack of headroom at HF.

It is very important that you use a line array that is long enough for the low-mid frequency projection to follow the superior mid and high frequency projection out far enough for mid-high air absorption to have a balancing effect.

The following curves show the spectral balance of 4 and 12 W8L cabinets vs distance taking air absorption into account for about 40% relative humidity.

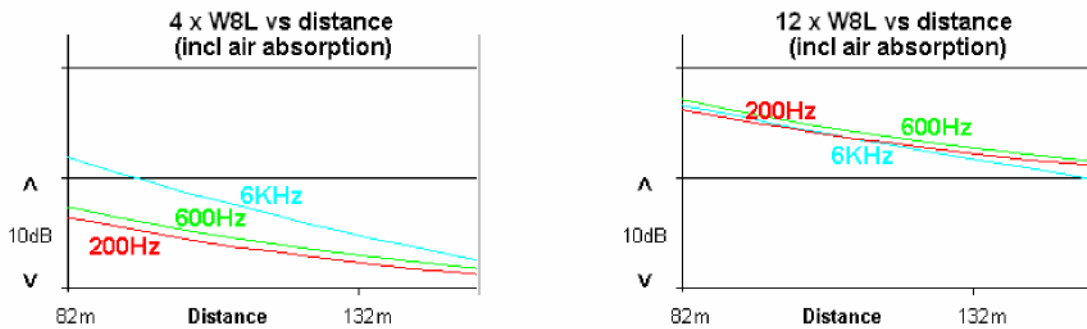

The 4-cabinet system low mid projection is less efficient than its upper mid projection because too few cabinets have been used for the line to be effective at low frequencies. The smaller system would project clean vocals but it would sound thin – lacking warmth and authority.

The 12-cabinet system 200Hz, 600Hz and 6KHz responses are closer together (and, obviously, at a higher amplitude). The longer line has "kicked" the low-mid frequencies out further so that they can keep up with the mid and high frequencies.

A 12-cabinet array provides excellent spectral tracking over typical stadium distances whilst providing the extra high frequency headroom required to partially counter air absorption.

Note that, as air absorption increases, upper mid frequency characteristics tend to track lower mid characteristics with high frequencies tailing off.

Model and quantity for a balanced spectral response

A spectrally balanced system will provide a useful far-field response within an octave of the product's LF and HF specification.

A system's LF response may be enhanced by extending the effective column length with subwoofers flown above or stacked immediately below the array.

HF air absorption is the dominant factor beyond 50m. Be cautious about specifying very long throw systems where the air may be dry (e.g. for outdoor events during hot, dry weather, for desert regions or for venues with warm air heating). See sections [5.8](#) & [5.9](#).

The chart on the following page indicates the minimum quantity and model for the required throw. The chart is based on applications experience and line array physics as it is currently understood.

Note: The cabinet quantities refer to low curvature arrays or the low curvature (upper) sections of progressively curved arrays.

Quantity	W8L Longbow (no subs)	W8LC (no subs)	W8LM (no subs)
Cabinets arrayed with 2° or less inter- cabinet splay	Throw (in meters) for spectral balance (8KHz loss equalisable)	Throw (in meters) for spectral balance (8KHz loss equalisable)	Throw (in meters) for spectral balance (8KHz loss equalisable)
4	25	18	12
6	40	29	18
8	60	40	25
10	80	58	32
12	100*	70	41
14	130**	88	50
16	155**	105*	60

* Assumes relative humidity 40% or higher at 25°C
 * * Assumes relative humidity 50% or higher at 25°C
 Lower humidity will cause unacceptable HF absorption

The following ViewPoint examples indicate the quantity of cabinets that can be regarded as contributing to the system's mid and high frequency far-field characteristic.

Example 1

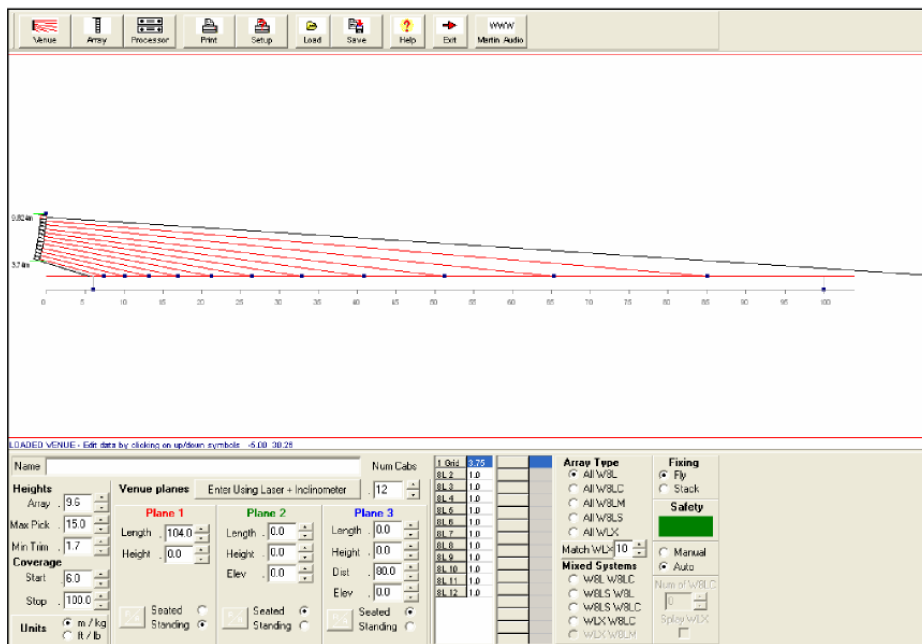

12xW8L or Longbow (at 1°) per side festival system in side wings for 100m throw

Example 2

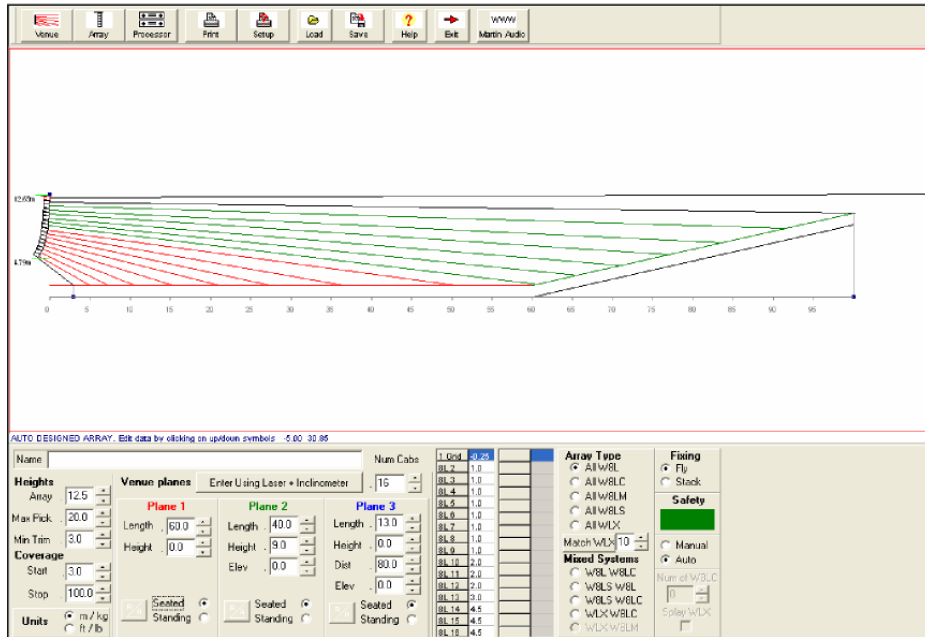

**16xW8L or Longbow per side arena system
Upper 12 cabinets at 1 & 2° for 100m throw**

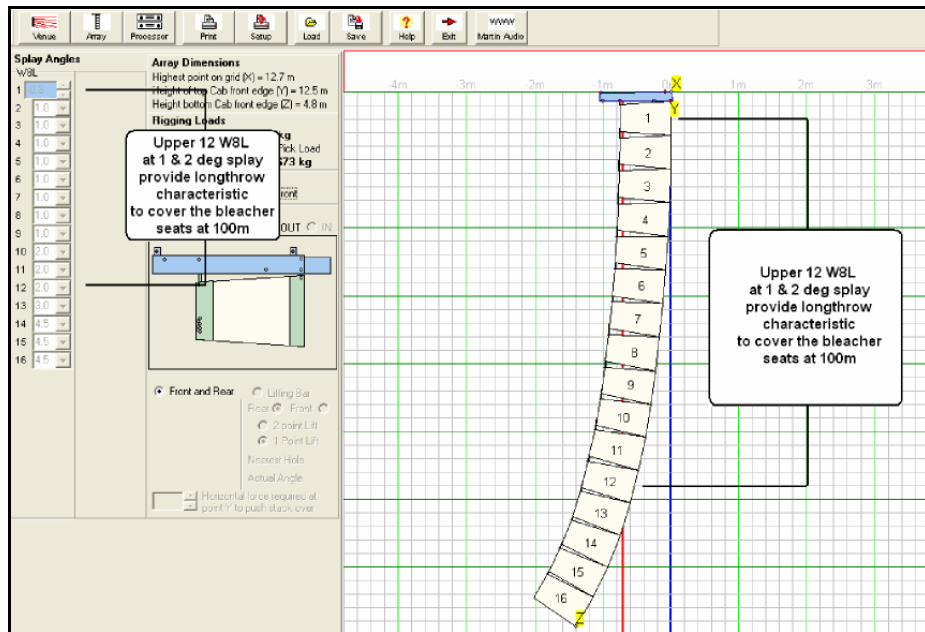

Array detail for above

5.4.2 Maximum far-field on-axis SPL Calculations

Simplified maximum far-field on-axis spl estimates for a single column may be made using the following simple arithmetic and look-up tables . . .

Far-field Sound Pressure Level (spl) = A minus B minus C

where **A = the effective source spl referred to 1m distance**
B = the radial attenuation with distance
C = excess air attenuation

- A)** The effective source spl is calculated for far-field estimates only (in practice, large array outputs do not integrate as close as 1m). This “source spl” will depend on the W8L Series model’s maximum spl, the number of cabinets and the splay angle between the cabinets. W8L Series cabinets have a nominal vertical MF & HF coverage of 7.5° so calculations have been restricted to 8 cabinets for 1° splay and 4 cabinets for 2° splay on the assumption that progressive curvature arrays start with minimal splay at the top for far-field projection, increasing towards the bottom. 0° (straight) arrays are calculated for up to 16 cabinets as curvature losses are not applicable.

See look-up table below.

- B)** Radial attenuation is the reduction in sound pressure due to the radial expansion of the wavefront. This attenuation varies from 3dB per doubling of distance in the near-field to 6dB per doubling in the far-field and depends on the length of the array.

See look-up table below.

- C)** Excess air attenuation is caused by air absorption. It is heavily dependent on humidity and temperature and is worse at mid and high frequencies. See look-up table below.

Value of A

Quantity (splayed at 0°)	Longbow Max dB spl cont. pk	W8LC Max dB spl cont. pk	W8LM Max dB spl cont. pk
1	142 148	129 135	125 131
2	148 154	135 141	131 137
4	154 160	141 147	137 143
6	158 164	145 151	141 147
8	160 166	147 153	143 149
10	162 168	149 155	145 151
12	164 170	151 157	147 153
14	165 171	152 158	148 154
16	166 172	153 159	149 155

Effective source spl (referred to 1m) - at 0° splay - vs model & quantity

Quantity (splayed at 1°)	Longbow Max dB spl		W8LC Max dB spl		W8LM Max dB spl	
	cont.	Pk	cont.	pk	cont.	pk
1	142	148	129	135	125	131
2	148	154	135	141	131	137
4	153	159	140	146	136	142
6	156	162	143	149	139	145
8	158	164	145	151	141	147

Effective source spl (referred to 1m) – at 1° splay - vs model & quantity

Quantity (splayed at 2°)	Longbow Max dB spl		W8LC Max dB spl		W8LM Max dB spl	
	cont.	pk	cont.	pk	cont.	pk
1	142	148	129	135	125	131
2	147	153	134	140	130	136
4	151	157	138	144	134	140

Effective source spl (referred to 1m) – at 2° splay -vs model & quantity

Value of B

Distance from array ?	1m array (2xLongbow, 3xW8LC or 4xW8LM)	2m array (4xLongbow, 5xW8LC or 8xW8LM)	4m array (8xLongbow, 11xW8LC or 16xW8M)	6m array (12xLongbow or 16xW8LC)	8m array (16xLongbow)
16m	15dB	12dB	12dB	12dB	12dB
32m	21dB	15dB	15dB	15dB	15dB
64m	27dB	21dB	18dB	18dB	18dB
128m	33dB	27dB	21dB	21dB	21dB
256m	39dB	33dB	27dB	24dB	24dB

Radial attenuation vs line array length & distance at 6KHz
(inter-cabinet splay = 1° or less)

Value of C

Distance from array ?	25% R.H.	50% R.H.	75% R.H.	100% R.H.
16m	2dB	1dB	0.7dB	0.6dB
32m	4dB	2dB	1.4dB	1.2dB
64m	8dB	4dB	2.8dB	2.3dB
128m	16dB	8dB	5.6dB	4.6dB
256m	32dB	16dB	11dB	9.2dB

Excess air attenuation vs distance at 6KHz (20°C at sea level)

Stereo Approximation

The above figures are for a single column. Centre-field maximum spl may increase by approximately 3dB at mid frequencies for stereo systems and may approach a 6dB increase at low frequencies.

Horizontal off-axis attenuation

Off-axis figures will be less than single column on-axis figures at mid and high frequencies as follows:

Horizontal off-axis attenuation	W8L or Longbow (± off-axis angle)	W8LC (± off-axis angle)	W8LM (± off-axis angle)
-3dB	22.5°	22.5°	25°
-6dB	45°	45°	50°
-10dB	60°	60°	60°

Note! Gusting side winds may affect these figures erratically.

5.5 ViewPoint (Version 3.0 or later)

Contents

- [5.5.1 Introduction](#)
- [5.5.2 Installing ViewPoint](#)
- [5.5.3 Using ViewPoint](#)
- [5.5.4 Entering venue data](#)
- [5.5.5 Coverage start and stop](#)
- [5.5.6 Array type](#)
- [5.5.7 Array fixing](#)
- [5.5.8 Designing a flown array](#)
- [5.5.9 Stacked systems](#)
- [5.5.10 Venue name](#)
- [5.5.11 Editing ViewPoint designs](#)
- [5.5.12 Frequently asked question](#)
- [5.5.13 Using ViewPoint for systems with subwoofers](#)

- 5.5.14 Manual array editing**
- 5.5.15 Array page**
- 5.5.16 Processor page**
- 5.5.17 Saving a design**
- 5.5.18 Loading a design**
- 5.5.19 Printing ViewPoint**
- 5.5.20 Exiting the programme**
- 5.5.22 Designing for venues with deep balconies**

ViewPoint (Version 3.0 or later)

5.5.1 Introduction

ViewPoint software will automatically calculate the splay angles of a W8L Series array and will indicate the optimum controller (processor) preset and amplifier patch information once venue and array data has been entered. You can print out array, venue, rigging and patch information and save your work to disk.

Note that ViewPoint produces results based on high resolution loudspeaker data and the audience coverage but you must use the amplifier patch and one of the controller preset indicated for accurate Band Zoning and smooth coverage.

The controller preset names shown on ViewPoint correspond to the preset names on our DX1, XTA DP226 or XTA AudioCore data files.

Please ensure that your controllers are set to our standard presets and that your system follows the recommended patch configuration (see sections [5.10](#), [5.11](#) & [5.12](#) near the end of this Applications Guide) for the W8L Series loudspeaker in use.

Users should start with a unity gain, zero delay, flat frequency response controller input section and revert back to our standard presets at the beginning of each venue setup to avoid using settings contaminated with input equalization or system delays from a previous gig.

5.5.2 Installing ViewPoint

ViewPoint is supplied in a zip folder which contains a setup executable file *ViewPoint 3.0*.exe*. For example:



Double-click on this and follow the on-screen prompts.

5.5.3 Using ViewPoint







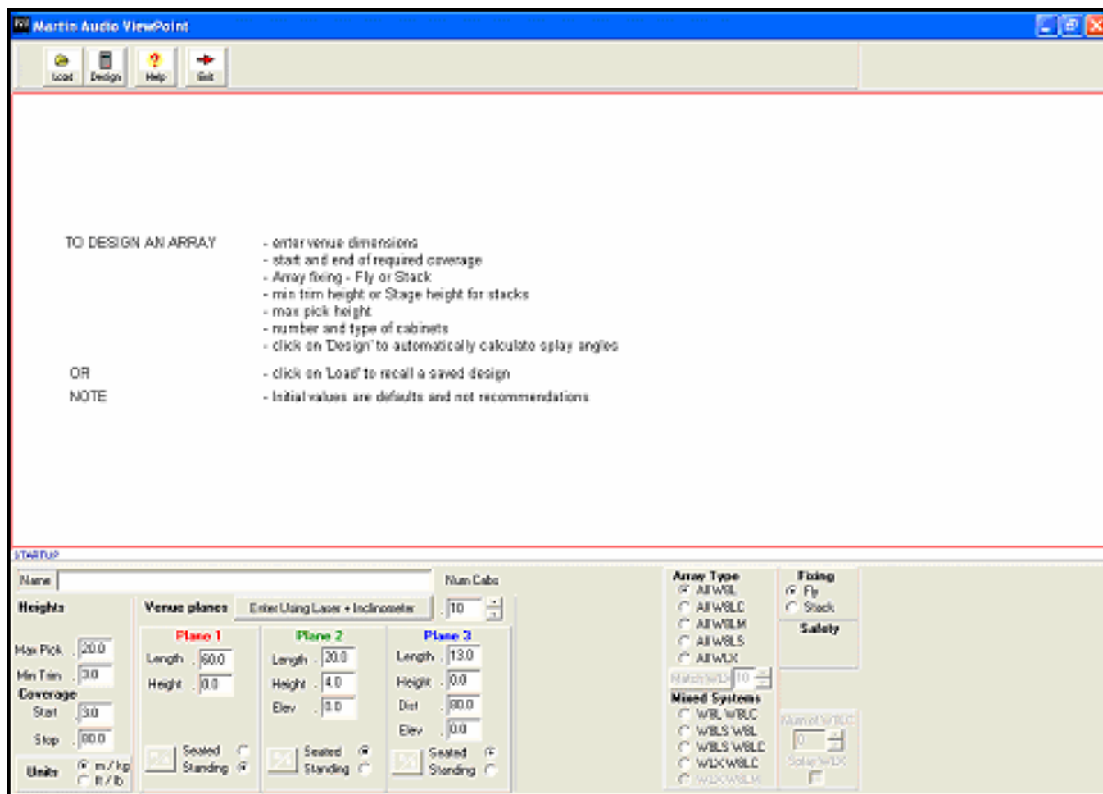

Once you have installed ViewPoint, it will be visible as a shortcut in All Programs via your Windows Start button.



A single click on the viewpoint v3.0* tab will open the following page:



ViewPointtm will indicate splay angles and controller presets for these flown systems:

-  W8L/Longbow (Full-range line array)
-  W8LD (W8L/Longbow width down-fill)
-  W8LS (W8L/Longbow width direct radiating, ported subwoofer)
-  W8LC (Compact line array)
-  W8LCD (W8LC width down-fill)
-  WLX (W8C width Hybrid™ sub woofer)
-  W8LM (Mini line array)
-  W8LMD (W8LM width down-fill)
-  WMX (W8LM width Hybrid™ subwoofer)

Plus various flown and stacked combinations of the above.

Contact viewpointsupport@martin-audio.com regularly
for the latest version of Viewpoint™

5.5.4 Entering venue data

Choose metric or imperial units using the **Units** box on the **Venue** page.

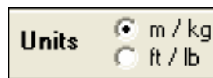

Click on the button adjacent to the units that you would like to use.

Note: if you enter dimensions in one unit system and then click on the button of the other system all dimensions will be converted, i.e. 1m will become 3.28ft.

PLEASE NOTE!

ViewPoint is designed as a line array design aid. It does not claim to be a high resolution drawing programme.

It indicates optimum line array curvature based on simple audience dimensions that may be gathered from basic venue drawings or from a quick on-site survey.

For best results, planes should be used as follows:

Plane 1 is used to simulate the main floor area from the stage to a rear bleacher or boundary.

Plane 3 is used to simulate the furthest/highest audience area.

Plane 2 is used for any audience area between Plane 1 and Plane 3.

Example:

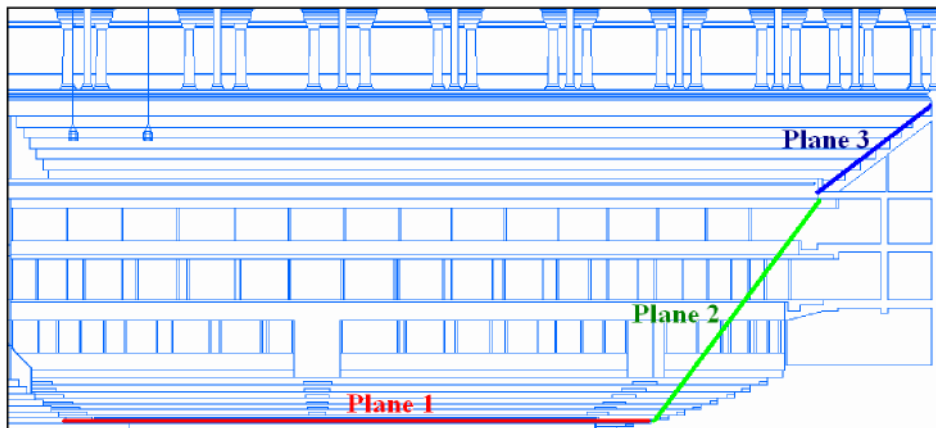

Plane 1, plane 2 & plane 3 decisions

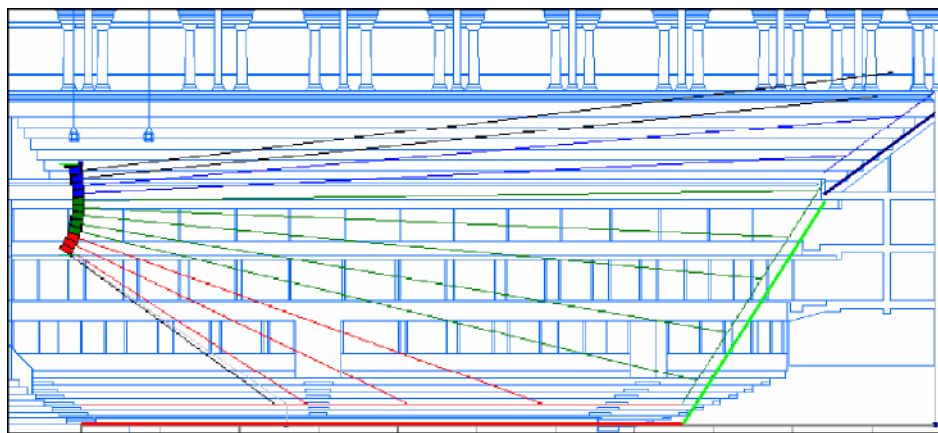

Overlaid ViewPoint screen (front fills not shown)

There are 3 methods for entering venue Dimensions.

5.5.4.1 Direct

If you have venue plans, enter the height, length and elevation for up to three planes.

Plane 1	Plane 2	Plane 3
Length . 60.0	Length . 20.0	Length . 13.0
Height . 0.0	Height . 4.0	Height . 0.0
	Elev . 0.0	Dist . 80.0
		Elev . 0.0
<input type="checkbox"/> Seated <input checked="" type="checkbox"/> Standing	<input type="checkbox"/> Seated <input checked="" type="checkbox"/> Standing	<input type="checkbox"/> Seated <input checked="" type="checkbox"/> Standing

- **Length** refers to the horizontal length of that plane
- **Height** refers to the height of the rear of the plane. Plane 1 height can be negative or positive.
- For planes two and three **Elev** refers to the elevation (height) of the front of the plane.
- For plane three **Distance** relates to the actual distance from the front of the array to the start of the third plane.
- For all planes selecting **Seated** or **Standing** places ear level at 1.4 or 1.8m above the respective plane.

5.5.4.2 Individual Plane R-A

To enter diagonal distance (R) and angle of elevation (A) instead of length (X) and height (Y) click on the symbol in the bottom left hand corner of a plane.



The following window will appear:

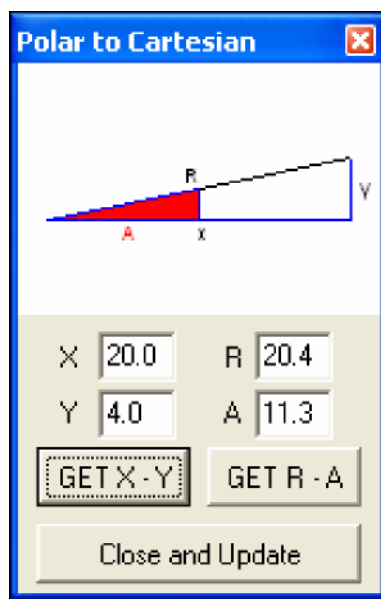

Enter R and A in the right hand boxes and click on **Get X-Y**.

Click on **Close and Update** to copy the X and Y data into the Length and Height boxes and close the pop-up window or click on the x symbol in the right hand corner of the pop-up window to close it without copying.

Note: You can also use this in reverse to calculate angles from X and Y data.

5.5.4.3 Single Point Survey

This option enables you to enter all plane data from a single reference point directly under the intended flying point or above the stack position.

We recommend that you use a tripod to mount your laser distance measurement device and your inclinometer since the data entered is very sensitive to small errors.

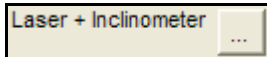

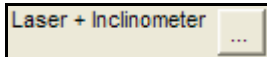
Click on  and a tool will appear that details the diagonal length and angle for each plane beginning and end.

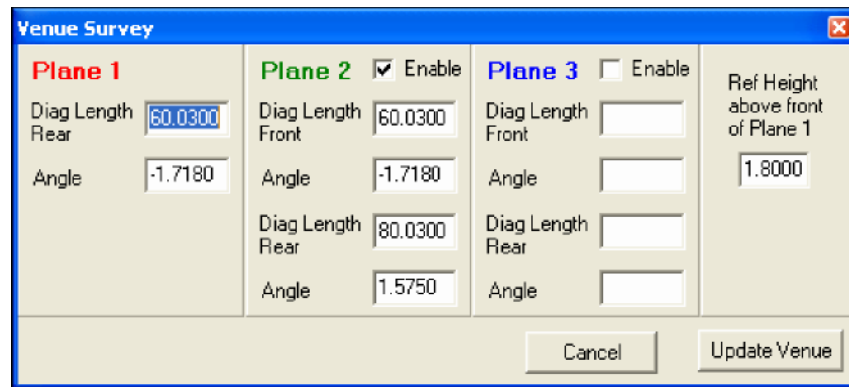

It also details the height of your distance measuring device above plane 1. If the stage is raised then include this height as well as the height of the device above the stage.

Note: It is assumed that plane 1 begins at the point where you mount the tripod and the array will be flown directly above it.

To enter data for each plane aim your device at the beginning and end of the plane and enter the values into the spaces provided. The units of measurement will be determined by the choice made in the main window and negative aiming angles imply the point aimed for is below the device.

Ensure that you have enabled or disabled the planes you require by checking the *enable* tick box for each plane.

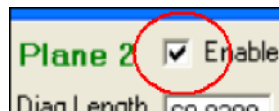

When you are satisfied with the data click *Update venue*, a conversion will then be made to the direct form of venue dimension.

You can switch back and forth between the single point survey and direct form at any time.

5.5.5 Coverage start and stop

Coverage	
Start	3.0
Stop	80.0

Specify the horizontal coverage distances from the front of the array. Coverage start and stop are shown as vertical grey bars on the view of the venue.

5.5.6 Array Type

Array Type	
<input checked="" type="radio"/>	All W8L
<input type="radio"/>	All W8LC
<input type="radio"/>	All W8LM
<input type="radio"/>	All W8LS
<input type="radio"/>	All WLX

The choice of loudspeaker type depends on the application. See W8L Series Applications Guide [section 5.4](#).

If a mixed system is selected a further section to the right allows you to define the quantity of the lower cabinets.

Num Cabs 10	1 Grid -0.75	8LC 1 0.0	Array Type <input checked="" type="radio"/> All W8L <input type="radio"/> All W8LC <input type="radio"/> All W8LM <input type="radio"/> All W8LS <input type="radio"/> All WLX	Fixing <input checked="" type="radio"/> Fly <input type="radio"/> Stack
	8LS 2 0.0	8LC 2 1.0		
lane 3 13.0 0.0 80.0 0.0		8LC 3 2.0	<input type="checkbox"/> Match WLX 10 Mixed Systems <input type="radio"/> W8L W8LC <input type="radio"/> W8LS W8L <input checked="" type="radio"/> W8LS W8LC <input type="radio"/> WLX W8LC <input type="radio"/> WLX W8LM	Safety <input type="radio"/> Manual <input checked="" type="radio"/> Auto
		8LC 4 3.0		
		8LC 5 4.0		
		8LC 6 5.0		
		8LC 7 6.0		
		8LC 8 6.0		
Seated <input checked="" type="radio"/> Standing <input type="radio"/>				Num of W8LC 8 Splay WLX <input type="checkbox"/>

5.5.7 Array Fixing

Select either *Fly* or *Stack* in the *Fixing* section to determine how the array is supported.

Array Type	Fixing
<input type="radio"/> All WBL	<input type="radio"/> Fly
<input checked="" type="radio"/> All WBLC	<input checked="" type="radio"/> Stack
<input type="radio"/> All WBLM	Safety

In *Fly* mode the grid is suspended and cabinets are attached beneath

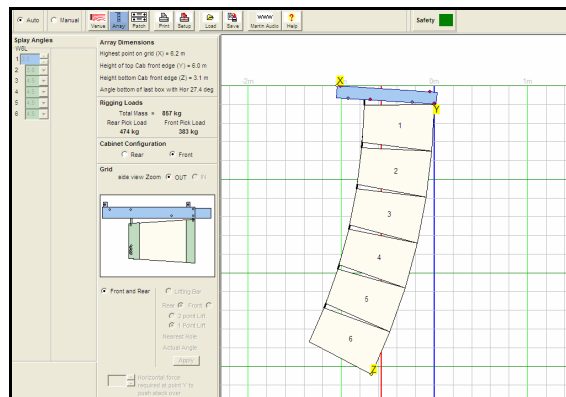

In *Stack* mode the grid forms a base and cabinets are placed on top. Ground Stack Bars are fixed between the grid and the rear splay holes of the lowest cabinet to set the overall system tilt.

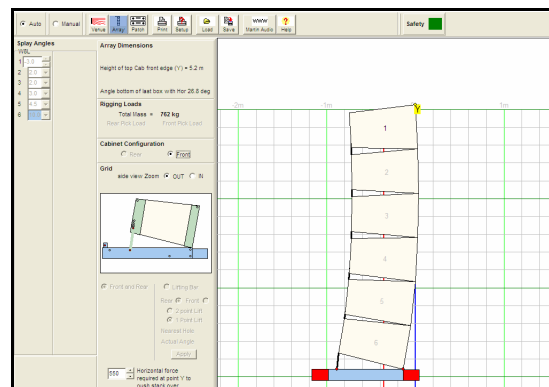

5.5.8 Designing a flown array

Minimum trim height

This is the low limit for the array and is defined as the smallest allowable distance from the lowest point of the array to the ground below.

You should set the minimum allowable trim height by sight line considerations.

Work this out from venue information gathered from venue and stage set information. Make sure the array does not restrict the audience view from 1.8m above the highest audience plane to 2m above the highest upstage artist position.

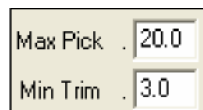

Maximum pick height

Set this to the maximum array height allowable (usually the highest part of the flying frame).

The maximum pick height is usually chosen to allow for the maximum flying point height minus a sensible allowance for any shackles, stingers, bridles or flying hooks.

1m should be allowed for a stinger between each grid flying lug and the relevant motor hook to ensure that motor chain bags do not rest on the grid or top cabinet and upset its tilt angle.

Array Height

Set the array height for best coverage. It refers to the highest point of the array but does not include shackles, stingers, bridles or flying hooks.

Array height is an important aspect of line array system design.

A low flown system may interfere with sightlines and may be too straight to provide the smooth coverage that would be provided by a progressively curved array. Low arrays may also fail to cover high side seats. If in doubt, check with DISPLAY™.

A high flown system may provide smooth coverage – but at the expense of maximum sound pressure level if the system curvature does not allow small enough inter-cabinet splay angles for efficient far-field projection. See [section 5.4](#) to relate maximum source spl to loudspeaker quantity and curvature. Always check with DISPLAY™ if you can.

A system flown too high will be uncomfortable for the audience as the sound source will not coincide with the performance area. High arrays can also cause rear wall echoes to reflect back into a lower audience area.

Example

Venue view – inefficient design

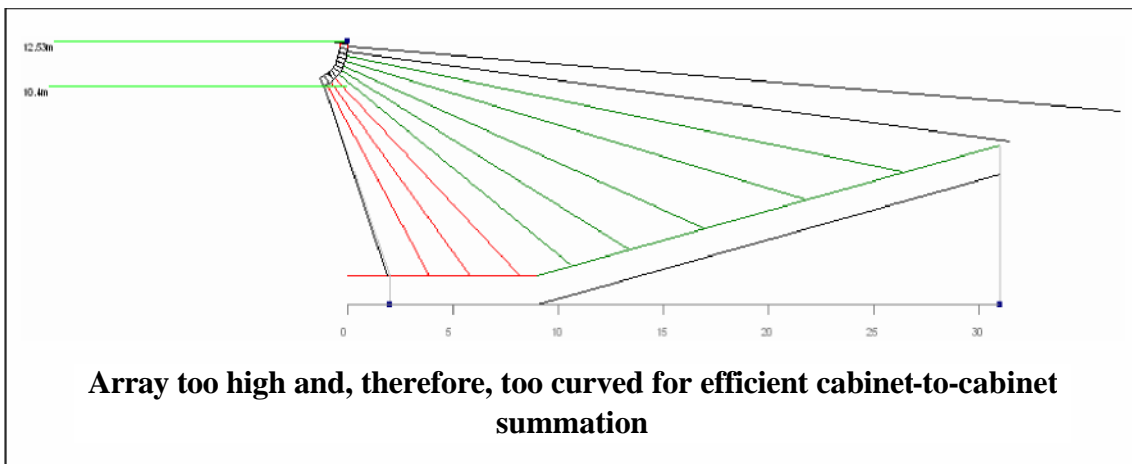

Array view – inefficient design

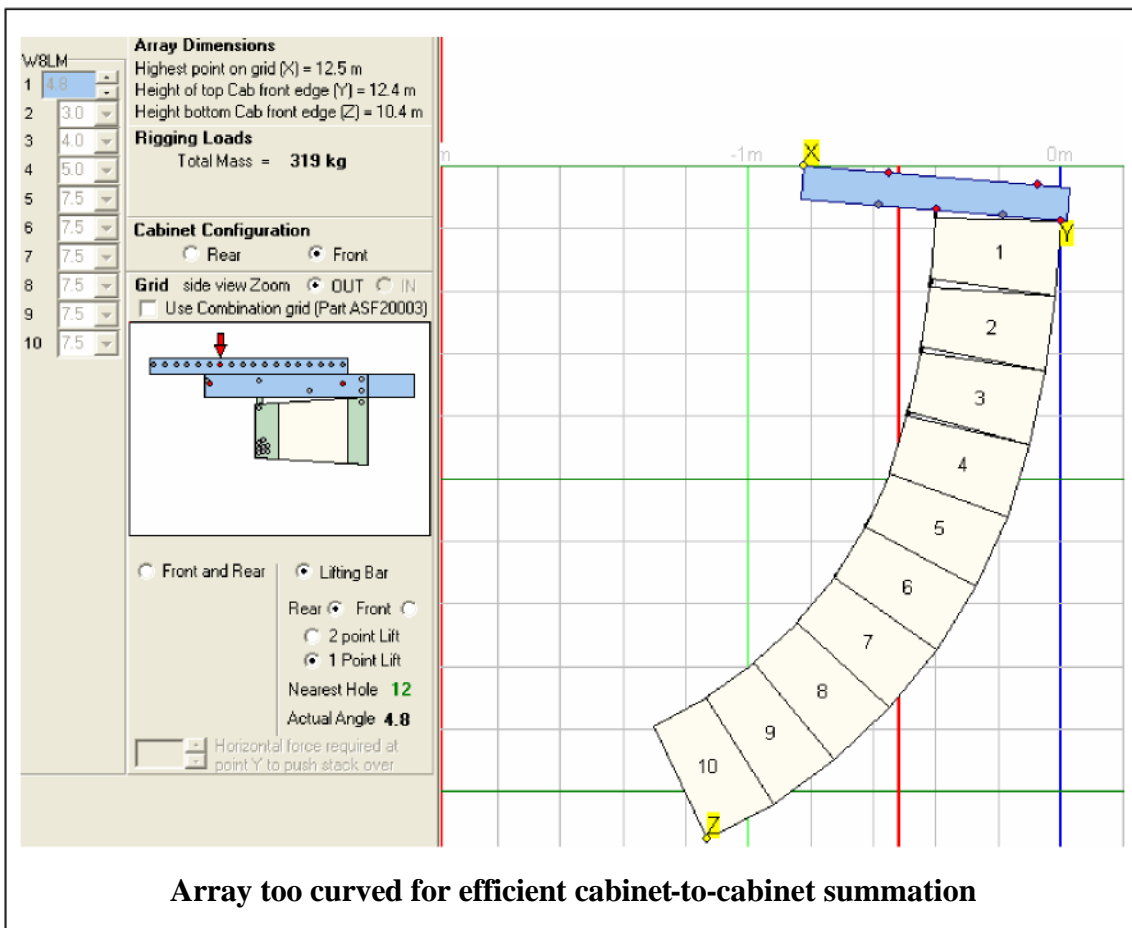

Venue view – efficient design

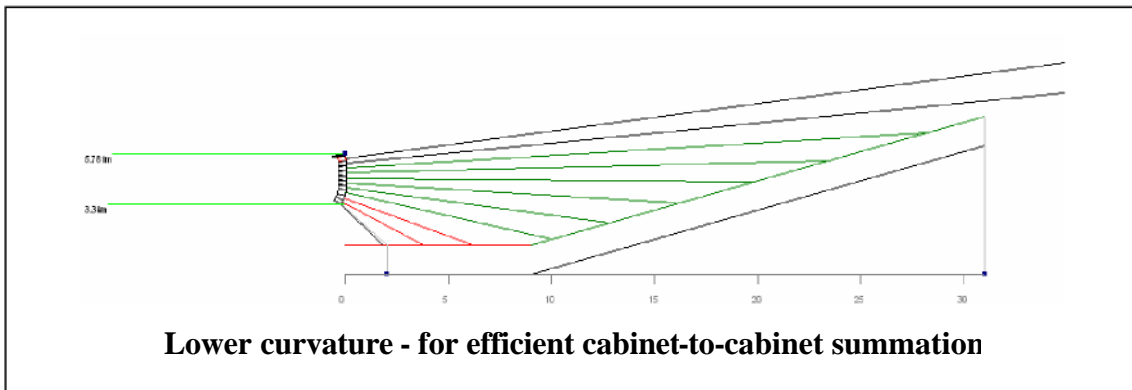

Array view – efficient design

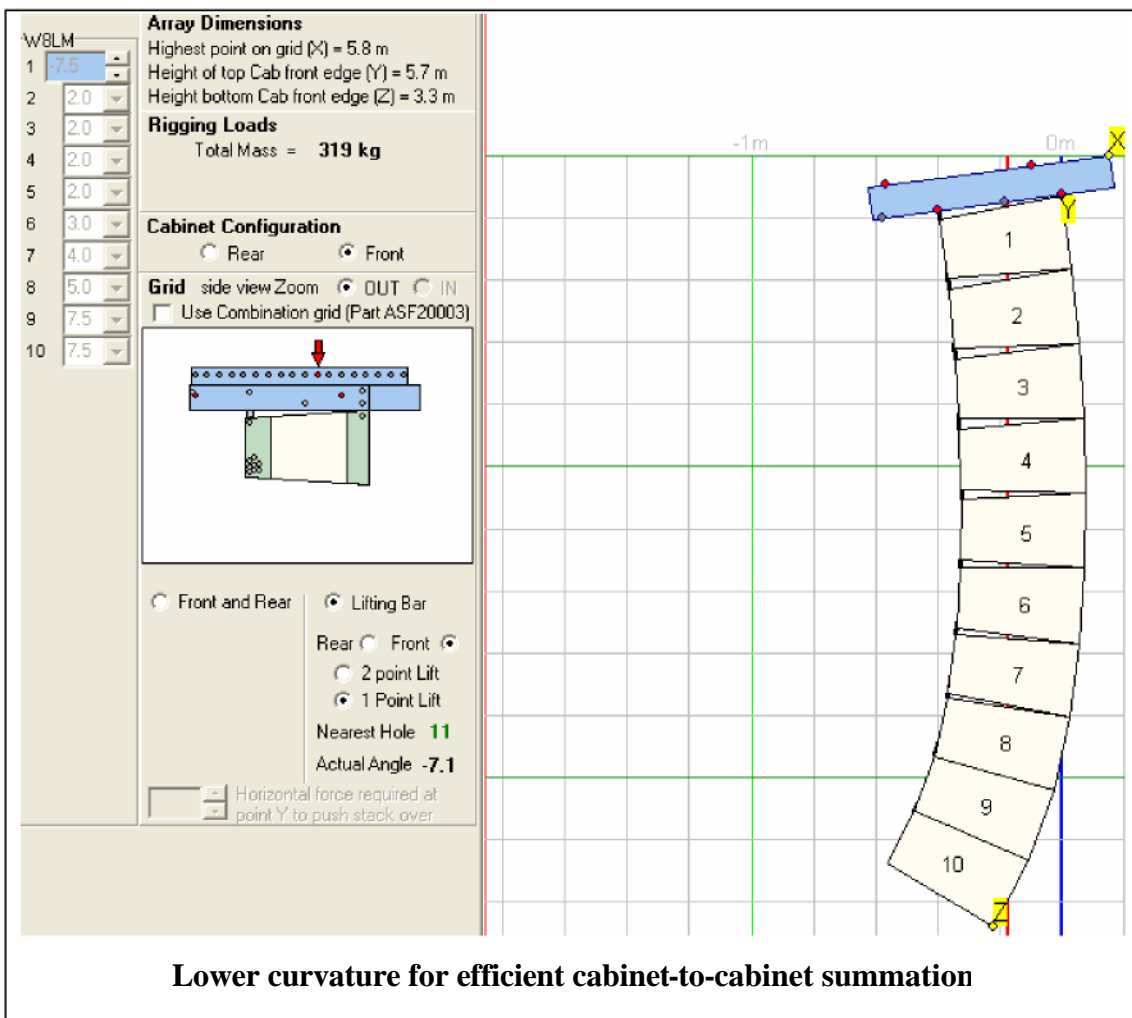

Caution – don't forget the side seats!

Always be aware of side seat coverage. A low, straight array provides great imaging and throw but may fail to cover high side seats. If in doubt, keep the grid height near the height of the highest seats. DISPLAY™ - Martin Audio's 3-D prediction programme - can be an invaluable decision making tool in these circumstances

Number of cabinets

The default value is 10 cabinets and this is a good starting point for most situations.

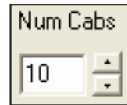

Click the *Design* button to see coverage, array length and splay angles.



You may wish to edit the number of cabinets to see how coverage, array length and splay angles are affected.

Note: the software will attempt to cover as wide an area as set by the coverage start and stop values. If the coverage (Start to Stop) cannot be met with the number of cabinets selected, a screen message will appear.

Coverage start not met

VERY IMPORTANT NOTE!!!

Long throw applications will require arrays long enough to ensure the appropriate vector summation for the distance to be covered. Too few cabinets may result in an inappropriate design. Once again, see [section 5.4](#).

Mixed systems

The number of cabinets in mixed systems relates to the total number of cabinets in the array. A separate control dictates how many of the lower cabinet types are present. See later.

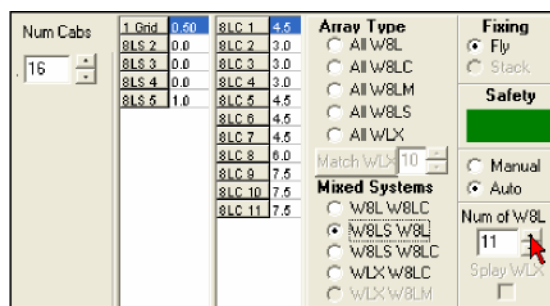

5.5.9 Stacked systems

When *Stack* is selected the maximum number of cabinets is limited and instead of *Array Height*, *Stage Height* appears in its place.

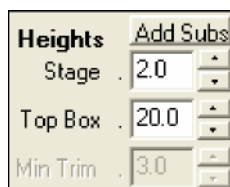

Set **Stage Height** to the vertical distance from the first plane to the floor of the stage. The **Add Subs** button allows the stack to be mounted on popular Martin Audio subwoofers – with the sub woofers either on the stage or stacked directly on the floor.

Note: If **Stage Height** is below the ear level of the first plane then the ear height becomes equal to the stage height.

5.5.10 Venue name

Enter the name of the venue. Previously saved venue names will appear here.



5.5.11 Editing ViewPoint designs

Once the initial venue and array parameters have been entered and the **Design** button has been clicked, venue and array data, can only be edited by clicking on the up or down symbols next to the appropriate data box.

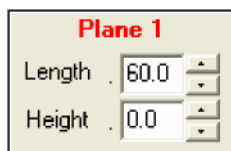

Whenever a value is altered the software will automatically recalculate splay angles.

5.5.12 Frequently asked questions

Q. Why is the top cabinet overshooting the furthest seat?

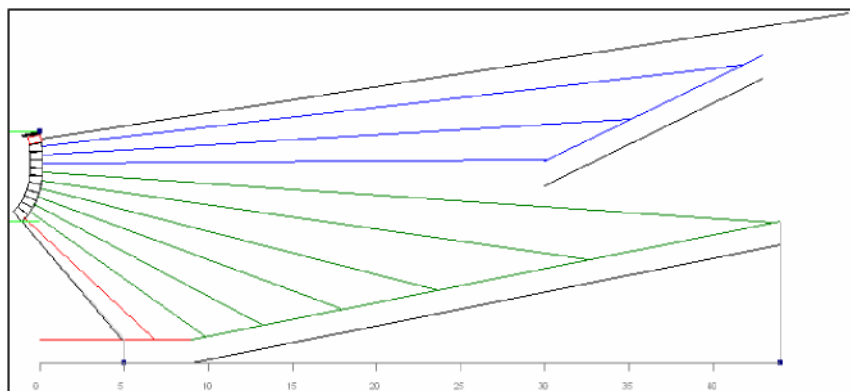

A. The auto calculation routine will tend to aim the top cabinet slightly beyond the coverage stop distance to give maximum vector summation at the furthest listening position. This is physics at work and is not a shortcoming of the W8 Series line arrays.

One benefit of this overshoot is that it can act as a hedge against coverage shortfalls caused by temperature and wind gradients bending the projected sound downwards. See [section 5.8](#) for further information about temperature and wind gradients.

Reducing echoes and overspill

ViewPoint's auto calculation routine is based on a combination of theoretical modeling* and practical experience and aims to give the most consistent frequency response over the audience surfaces as well as an even SPL distribution. We strongly recommend using ViewPoint's recommendations before attempting different schemes.

If there are highly reflective surfaces (or sensitive neighbours!) immediately beyond the **Coverage stop** point you may wish to reduce the overshoot at that point. This may be done by reducing the coverage stop distance until the top cabinet ray coincides with the highest/furthest audience area. The trade-off will be a slight (approx 2dB) loss of level at the highest seat in return for an echo reduction.

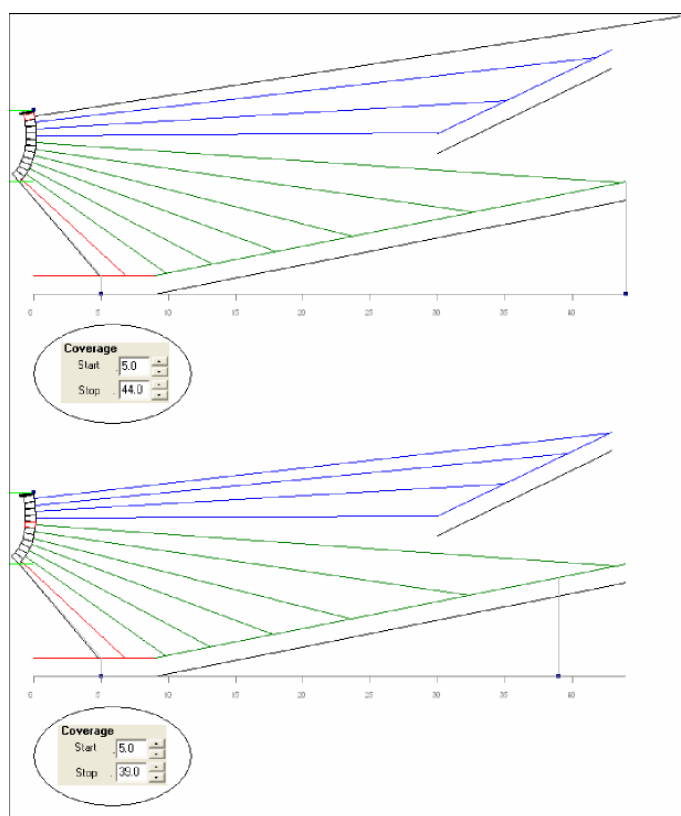

Reducing echoes by trimming the coverage stop

Direct echoes may be made less audible in the audience by placing the array at or, if there are no high side seats, slightly below the height of the furthest seats.

Q. The cabinet rays are spaced further apart in the 45 – 75m area. Surely this means that just one cabinet is covering more than fifteen meters of the audience?

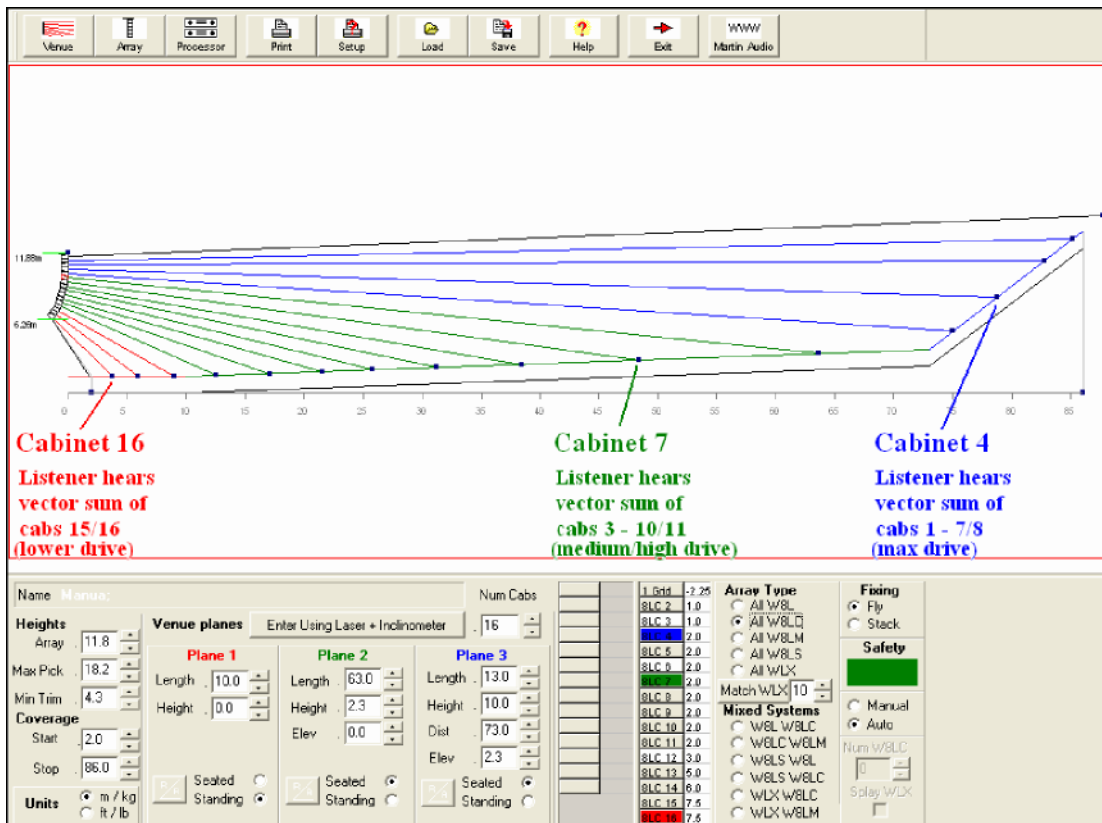

A. The rays shown on ViewPoint can be a little misleading because a series of rays arriving at a shallow angle will appear to be widely spaced.

Many users equate this with the sun's rays which weaken as the sun sets. In fact, the setting sun's power weakens due to greater absorption of shorter wavelengths through the earth's curved atmosphere not because the rays are arriving at a shallow angle.

With W8L Series arrays, the sound pressure level at any point in the room can be thought of as the vector sum of all the cabinets +/-7.5 degrees from that point, not simply due to the cabinet whose ray is aiming there. The example above shows that the "cabinet 7" area receives contributions from cabinets 3 to 11, not just cabinet 7. ViewPoint's Progressive Curvature calculations ensure that inter-cabinet splay angles increase gradually from the array and arrays are driven slightly harder towards the top of the array to partially compensate for air losses. This combination of Progressive Curvature and Band Zoning gives maximum projection to the furthest seats and the smoothest coverage.

5.5.13 Using ViewPoint for systems with subwoofers

Flown W8LS subwoofers

By default all W8LS splay angles are set to zero. If possible, raise the array height so that the W8LS cabinets are pointing downwards – or consider a parallel (side) W8LS or WLX subwoofer array.

W8LS side arrays

Matching a W8LS side array to the curvature of the main W8L Longbow system is easy. Simply copy the array shape exactly.

WLX side arrays

If you specify a WLX side array it should be designed to match the curvature of the main array. Matching adjacent WLX and W8LC array shapes is difficult (as they are different shapes and sizes) so ViewPoint does it for you.

Enter the number of WLXs you wish to use in the number box to the right of the **Match WLX** button, then click the **Match WLX** button.



A WLX array is generated that has a similar shape to your original main array.

Splaying WLX cabinets in mixed systems

In mixed WLX/W8LC systems ViewPoint may be used to aim the upper WLXs as close to the main audience area as the rigging system will allow whilst keeping the lower W8LC array pointing in the correct position for best coverage.

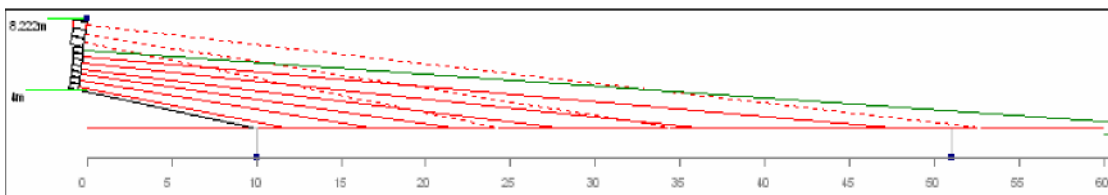

Click the **Splay WLX** control to enable/disable this feature.

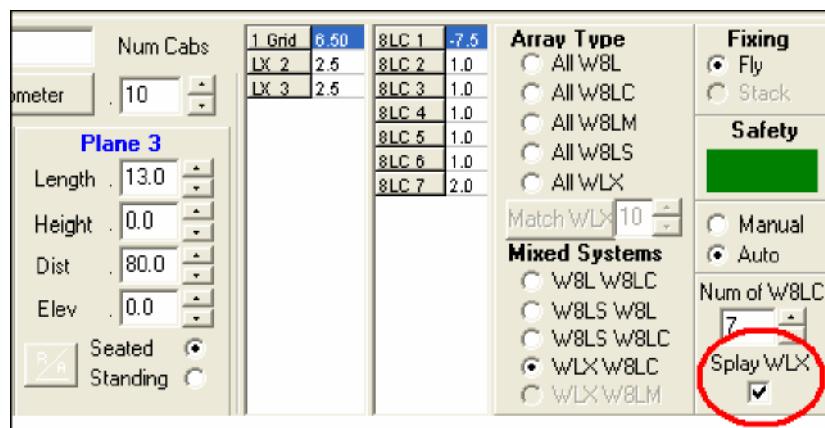

For subwoofer placement and alignment tips, see [section 5.7](#).

5.5.14 Manual array editing (experts only)

Should you wish to ignore ViewPoint's accurate coverage advice, continue with great caution, as follows:



Click on the Manual button (in Venue view) to manually edit splay angles and the array tilt angle.

- 1) Position the cross-hair over the dark blue squares at the end of each ray until the box turns red.
- 2) Use the left and right mouse buttons to increase or decrease the array tilt (top cabinet only) or inter-cabinet splay angles of the cabinets below.

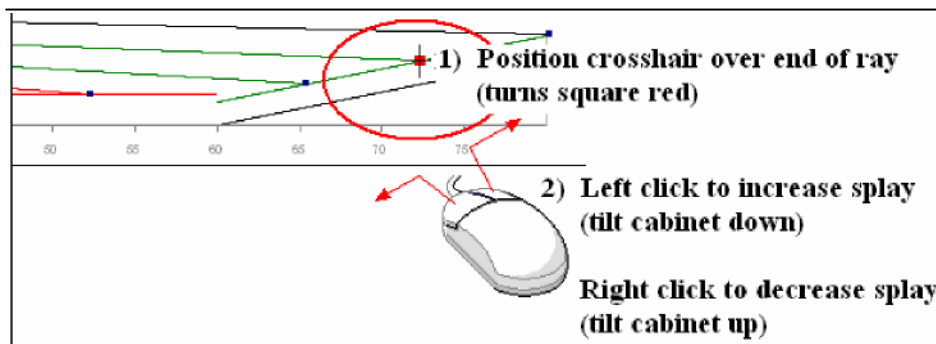

Alternatively ...

- 1) Click on the splay angle to be altered to select a cabinet.

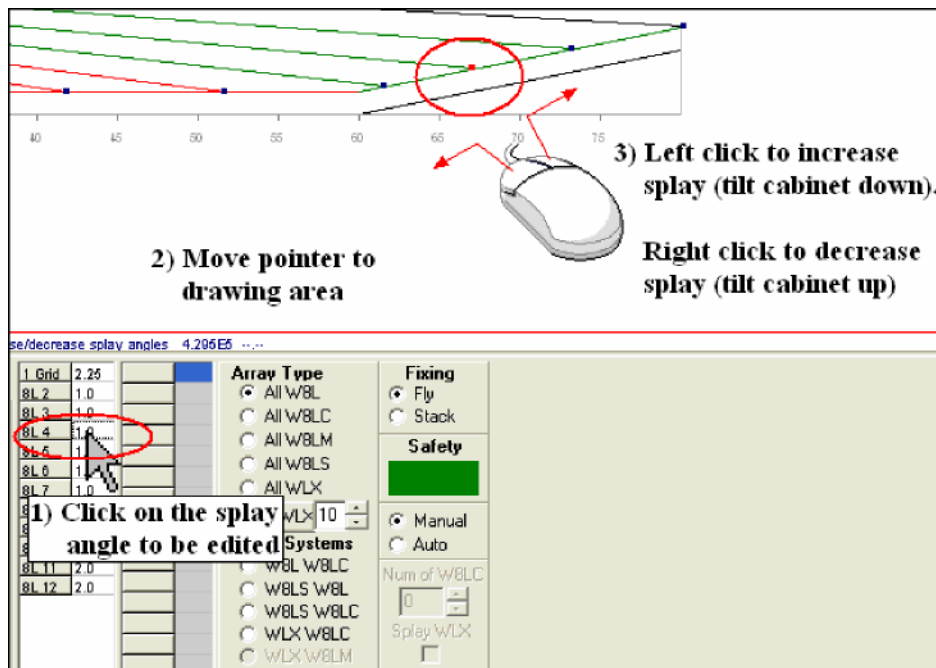

- 2) Move the mouse pointer into the top half of the screen.

3) Use the mouse buttons as described to change the angle. This is useful when the blue squares at the end of the uppermost rays lie outside the displayable area.

Note that the ray colours relate to Planes 1, 2 and 3. Occasionally, when a venue involves three planes or the second plane is a balcony which is above the level of the first plane, the auto calculation routine will indicate **black ray(s)** not pointing at the audience. This occurs when rays hit a vertical surface such as a balcony front.

Do not be tempted to switch off or heavily attenuate cabinets indicating a black ray as this could upset the line effect producing lobes and causing room colouration.

The user has the choice of ignoring the warning, which may be advisable if the balcony front is small or non-reflective, or manually editing the splay angles to miss the reflective surface.

It is not advisable to miss the surface completely as temperature gradients in the air can steer high frequencies upwards or downwards by 5° or more from the direction the cabinets are pointing in.

5.5.15 Array Page

Please note!

ViewPoint's Array page is for design/decision making only.

It does not guarantee safety. Safety will depend on the condition of the product, the suitability of supporting structures and personnel, weather conditions etc.

ViewPoint information should be passed to suitably qualified and experienced riggers for final decisions about loading, stability and safety.

5.5.15.1 Flown arrays

Click on the *Array* tab to show the rigging configuration and mechanical parameters.

This shows a close up of the array along with dimensions and splay angles. The gridlines are calibrated in 0.2m or 0.5ft increments, depending on which unit system is selected. Using the gridlines it is possible to read off dimensions such as the depth of any part of the array.

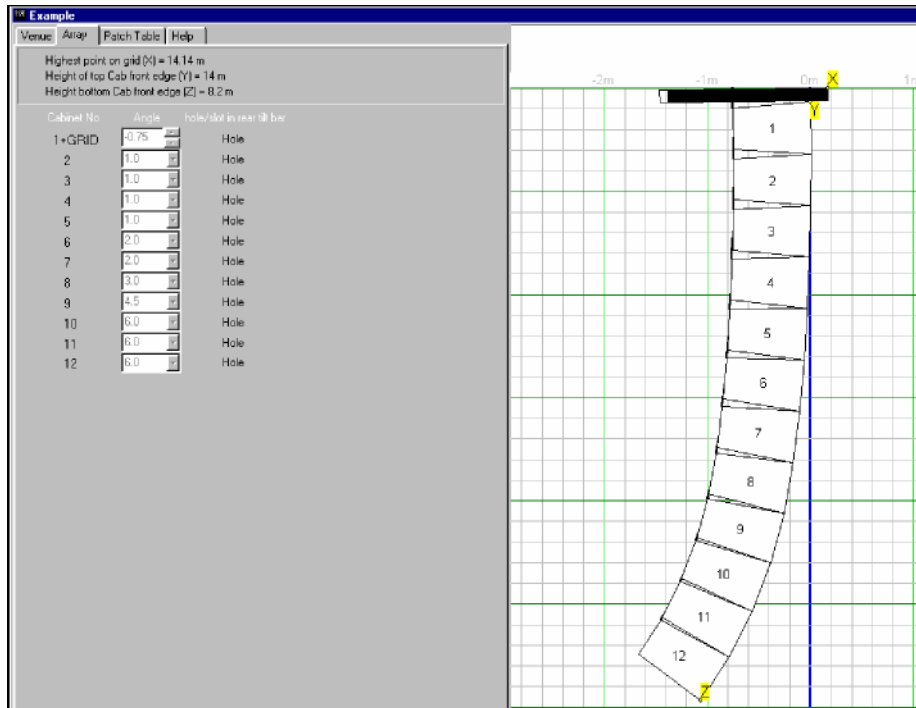

Note that the top front edge of the upper cabinet is the distance reference point. This is indicated as a blue vertical line on the *Array* view which indicates the datum point from which coverage Start/Stop distances are measured.

Pick Points and Cabinet Positions

Two grid pick points (front & rear) are shown for flown arrays.

<p>Array Dimensions Highest point on grid (X) = 8.1 m Height of top Cab front edge (Y) = 7.9 m Height bottom Cab front edge (Z) = 3.0 m</p> <p>Rigging Loads Total Mass = 1365 kg Rear Pick Load Front Pick Load 643 kg 722 kg</p> <p>Cabinet Configuration <input type="radio"/> Rear <input checked="" type="radio"/> Front</p> <p>Grid Configuration Grid Side View Zoom <input checked="" type="radio"/> OUT <input type="radio"/> IN</p> <p><input checked="" type="radio"/> Front and Rear <input type="radio"/> Lifting Bar</p>	<p>Array Dimensions Highest point on grid (X) = 8.1 m Height of top Cab front edge (Y) = 7.9 m Height bottom Cab front edge (Z) = 3.0 m</p> <p>Rigging Loads Total Mass = 1365 kg Rear Pick Load Front Pick Load 966 kg 399 kg</p> <p>Cabinet Configuration <input checked="" type="radio"/> Rear <input type="radio"/> Front</p> <p>Grid Configuration Grid Side View Zoom <input checked="" type="radio"/> OUT <input type="radio"/> IN</p> <p><input checked="" type="radio"/> Front and Rear <input type="radio"/> Lifting Bar</p>
---	---

The cabinet grid position can be selected as either Front or Rear depending on the amount of system tilt required. The rear positions makes more down-tilt (+ve angle) available and the front position makes more up-tilt (-ve angle) available.

Lifting Bar Option

A *Lifting Bar* option is available for W8LC, WLX and W8LM flown arrays.

When *Lifting Bar* is selected, further options become available.

The lifting bar can be placed in the *Rear* or *Front* position and can be lifted at either one or two points.

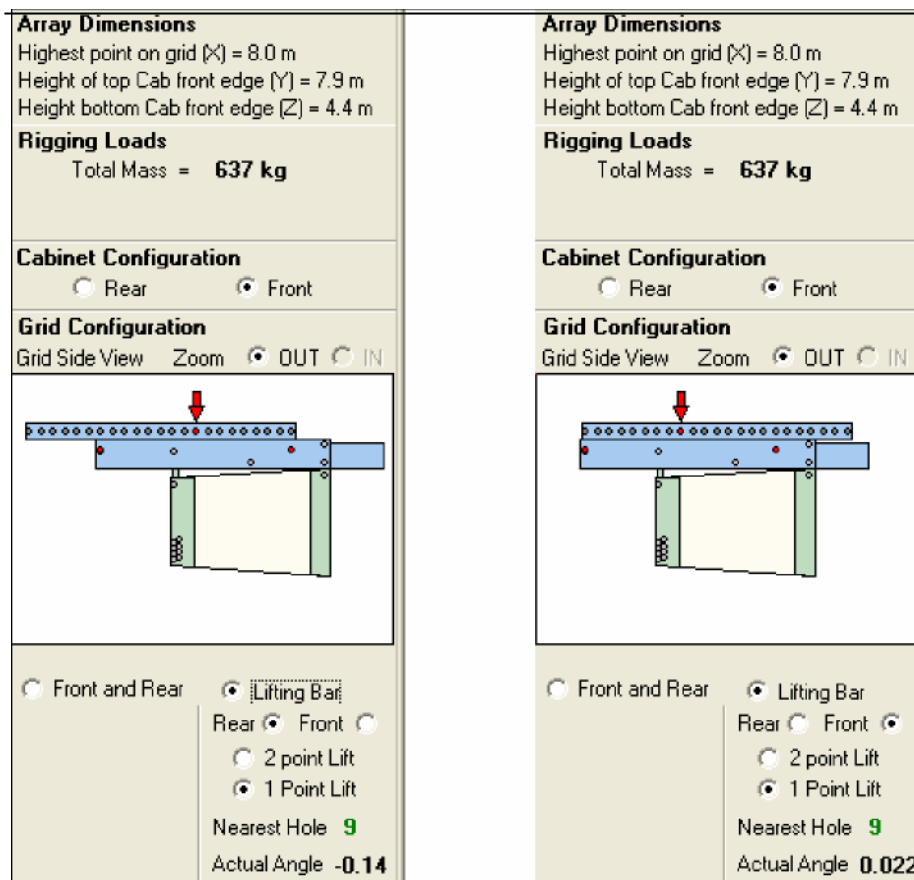

Single Point Lift

This displays the *Nearest hole* in the lifting bar and the *Actual Angle* of the grid when lifted at that hole.

Note that ViewPoint will display a warning if there is no suitable hole available.

C.O.G is not coincident with any Hole

If the required lifting point is too far back, make sure the lifting bar is in the rear position and that the cabinet is mounted at the front of the grid before trying an alternative height. Similarly, if the required lifting point is too far forward, make sure the lifting bar is in the front position and the cabinet is mounted at the rear of the grid before trying an alternative height.

Adjusting the array height slightly on the *Venue* page will often position the system on a suitable hole or narrow the gap between the required angle and the angle given by the nearest hole. Flip between *Venue* and *Array* views to set and recheck.

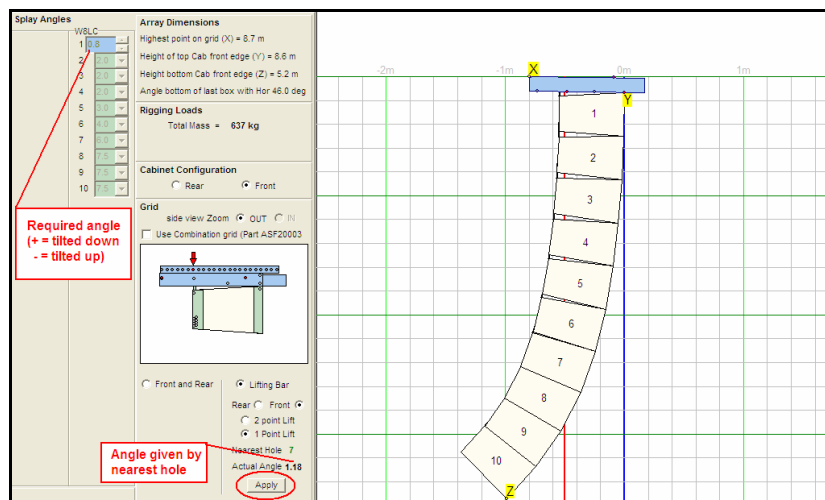

Slight difference between required tilt and tilt given by nearest lifting bar hole

Alternatively, you may click on the *Apply* button (circled). This applies the actual angle ($\pm 0.1^\circ$) given by the nearest lifting bar hole to the design by switching ViewPoint to *Manual* mode. Check that coverage start is met (*Venue* view) before accepting this.

Two Point Lift

This places a pick point at each end of the bar.

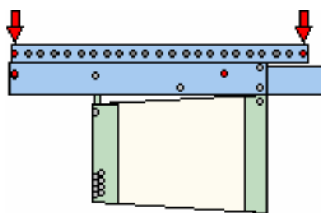

A two-motor lift from a lifting bar will...

- Enable more extreme up-tilts and down-tilts because the lifting bar extends beyond the front lifting point forward of the normal grid tab in the front position and extends the rear lifting point behind the normal grid tab in the rear position
- Spread the array load across two rigging points
- Allow fine angular control using the motors

Load Indicators

Depending on the grid configuration the 'Rear Pick Load' and 'Front Pick Load' are displayed as well as total mass. These loads as well as the forces between cabinets are checked after each change of the array or grid.

Rigging Loads	
Total Mass =	1365 kg
Rear Pick Load	Front Pick Load
643 kg	722 kg

Should either of the pick loads become less than zero or the inter-cabinet forces become too high then a mechanical warning window will appear.

Mechanical Safety Warning		
Position	Load	Safety factor
Cabinet Front links	-516.73 kg	16.92
Cabinet Rear links	1507.30 kg	7.52
Grid Front Pick point	-114.63 kg	250.81
Grid Rear Pick point	1860.60 kg	15.45
COG Position	NOT between pick points	

Help >>

5.5.15.2 Stacked arrays

When designing ground-stacked arrays, inspect the array view and check that the center of gravity is in a safe place.

Stack stability

Red stability limits are indicated within the grid on the Array page – circled on the right below.

If the centre of gravity crosses this red region the force required to push or pull the array over is less than that shown in the box beside the array view and a mechanical warning is raised.

Please note: This assumes that no sliding takes place. Grids should be securely attached to the ground in all cases. The push value (in Newtons) – shown circled on the left below - can be varied to simulate wind load.

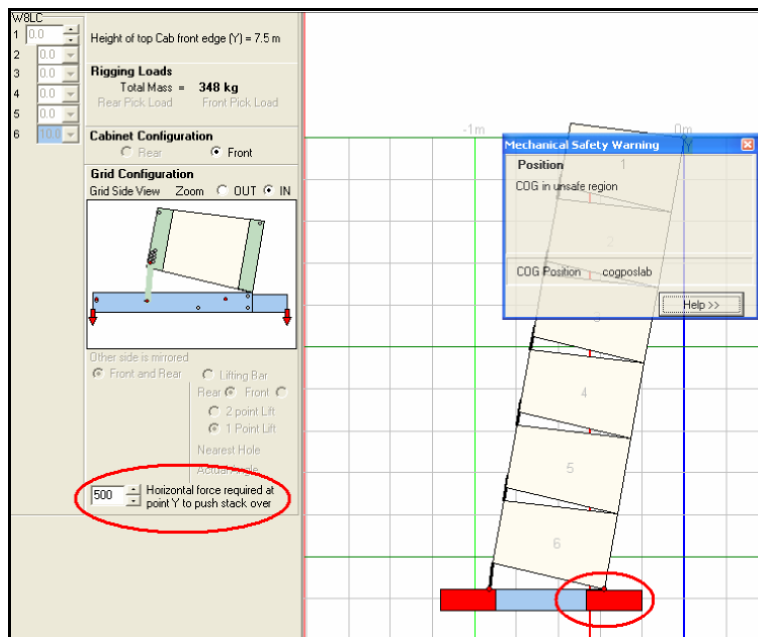

Zoom In

This shows the ground-stack bar position required for the lowest cabinet angle.

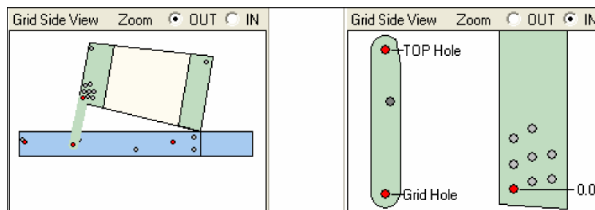

5.5.16 Processor page

The Processor page shows a controller-to-amplifier patch table and indicates which controller settings to use for the design. The system patch is very important because it controls the level of band-zoning applied to the array.

Please ensure that your system patch and controller preset selection is correct by following ViewPoint's recommendations and by following the patch information in the appropriate Quick Start Guide towards the end of this document.

Controller Settings						
- Standard HF EQ						
16W8LC HF NORM						
- Reduced HF EQ						
16W8LC HF CUT						
- Increased HF EQ						
16W8LC HF BOOST						
TILT AND SPLAY ANGLES			SPEAKER	CONTROLLER O/P CHAN		
CAB	ANGLE	TYPE	O/P GROUP	LF	MF	HF
1+Grid	1.25	W8LC	H	1	3	6
2	1.0	W8LC	H	1	3	6
3	1.0	W8LC	G	1	3	6
4	1.0	W8LC	G	1	3	6
5	1.0	W8LC	F	1	3	6
6	1.0	W8LC	F	1	3	6
7	1.0	W8LC	E	1	3	6
8	2.0	W8LC	E	1	3	6
9	2.0	W8LC	D	1	3	6
10	2.0	W8LC	D	1	3	6
11	2.0	W8LC	C	1	3	5
12	2.0	W8LC	C	1	3	5
13	2.0	W8LC	B	1	2	5
14	2.0	W8LC	B	1	2	5
15	2.0	W8LC	A	1	2	4
16	3.0	W8LC	A	1	2	4

Controller presets

The recommended DX1 or XTA DP226 controller preset is shown on the Processor page. Most of our line array controller presets include extra channels for Band-zoning. Band-zoning is a technique of splitting the array into various MF and HF zones to provide more air absorption compensation for the upper (longer throw) sections.

Rack patches

Historically, cabinets in large loudspeaker array have been numbered from top to bottom (see the CAB column in the patch table). Unfortunately, this traditional numbering scheme is not well suited to line array technology because line arrays tend to be band-zoned and grouped from the bottom up. Arrays are extended by adding straighter sections

to the top.

To avoid the confusion of two numbering standards, we use the traditional top-down number standard for the individual cabinets and a bottom-up lettering standard for band-zoning groups. See the SPEAKER O/P GROUP column. Group A is at the bottom of the array and drives the bottom two loudspeakers 15 & 16.

W8L Series impedances and grouping

W8L Longbow and W8LC line array section impedances are all 8 ohms and usually driven in pairs so that each power amplifier channel sees a 4 ohm load. W8LM line array section impedances are about 13 ohms and are usually driven in fours to present a 3.25 ohm load.

Multipurpose racks are easily configured for a wide variety of array sizes by using this bottom-up lettering scheme. Smaller line array configurations can be driven from large multipurpose racks by leaving the upper, more equalized, outlets unused.

The following example relates bottom-up rack outlet lettering to traditional top-down cabinet numbering for 16-cab and 8-cab systems.



Note that W8L Longbows and W8LCs are driven in pairs (8ohms//8ohms = 4ohms) whereas W8LMs are driven in fours (13ohms//13ohms//13ohms//13ohms = 3.25ohms).

Speaker Outlet	W8L, Longbow or W8LC 16-cab system (paralleled in pairs)	W8L, Longbow or W8LC 8-cab system (paralleled in pairs)	W8L, Longbow or W8LC 4-cab system (paralleled in pairs)	W8LM 16-cab system (paralleled in fours)	W8LM 8-cab system (paralleled in fours)	W8LM 4-cab system (paralleled in fours)
H	1&2					
G	3&4					
F	5&6					
E	7&8					
D	9&10	1&2		1-4		
C	11&12	3&4		5-8		
B	13&14	5&6	1&2	9-12	1-4	
A	15&16	7&8	3&4	13-16	5-8	1-4

A typical large scale system will have its LF sections driven in unison, its MF split into upper (far-field) and lower (near-field) zones and its HF split into upper (far-field), middle (mid-field) and lower (near-field) zones.



See [section 5.9](#) for more on Band Zoning plus [sections 5.10 \(W8L or Longbow\)](#), [5.11 \(W8LC\)](#) or [5.12 \(W8LM\)](#) for rack info.

Note that W8L Longbow and W8LC presets also offer a choice of settings:

-  HFCUT
-  HFNORMAL
-  HFBOOST

These are intended to cater for differing propagation conditions and, of course, personal taste.

We recommend the following settings for differing humidity conditions:

-  HF BOOST when RH = 10 to 30%
-  HF NORMAL when RH = 30 to 50%
-  HF CUT when RH = 50 to 100%.

W8L presets have an HF VARIABLE setting to allow the user to manually adjust HF equalisation for atmospheric effects and personal taste.

A reminder ...

ViewPoint produces sonically accurate results based on high resolution loudspeaker data and the audience coverage. You must use the recommended preset and amplifier patch for accurate Band Zoning and smooth coverage.

- 1) The controller preset names shown on ViewPoint correspond to the preset names on our published Martin Audio DX1, XTA DP226 or XTA AudioCore data files.**
- 2) Please ensure that controllers are loaded with the recommended presets for the loudspeaker in use.**
- 3) Users should start with a unity gain, zero delay, flat frequency response controller input section and revert back to our standard presets at the beginning of each venue setup to avoid using settings contaminated with room equalization from a previous event.**

5.5.17 Saving a venue or array design to disk

Select the *Venue* page and click on *Save*.

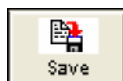

The normal Windows *Save As* dialogue box will pop up.

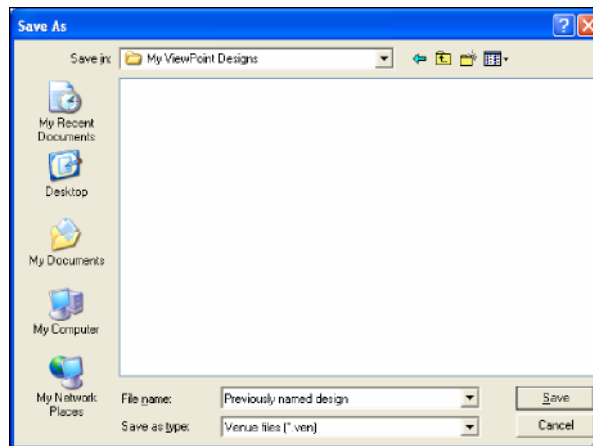

If you have already entered a venue name, this will be used as the default filename. Create a new folder or select an existing destination and click Save.

5.5.18. Loading a venue or array design from disk

Select the *Venue* page and click on *Load*. The normal Windows Open dialogue box will pop up. Browse the *Look in* drop down menu to select the required *.ven* file and highlight it. Click *Open*.



5.5.19 Printing ViewPoint

Printer Setup

Select the Venue page and click on Setup.



A printer and paper size may be selected via the normal Windows Print Setup panel.

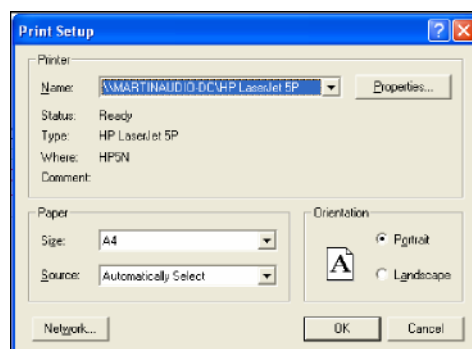

ViewPoint will automatically select portrait or landscape printing as required.

Note: If you have *Adobe Acrobat* software, selecting *Acrobat PDF Writer* will enable you to produce an *Adobe Acrobat .pdf* file suitable for emailing to PC and Mac users alike. We have found *PDF Writer* to be more reliable than *Distiller* at all resolutions.

Printing venue and array information

Select the *Venue* page and click *Print*.



This will print out the sectional view of the venue and the array to provide a hard copy of array position and venue coverage.

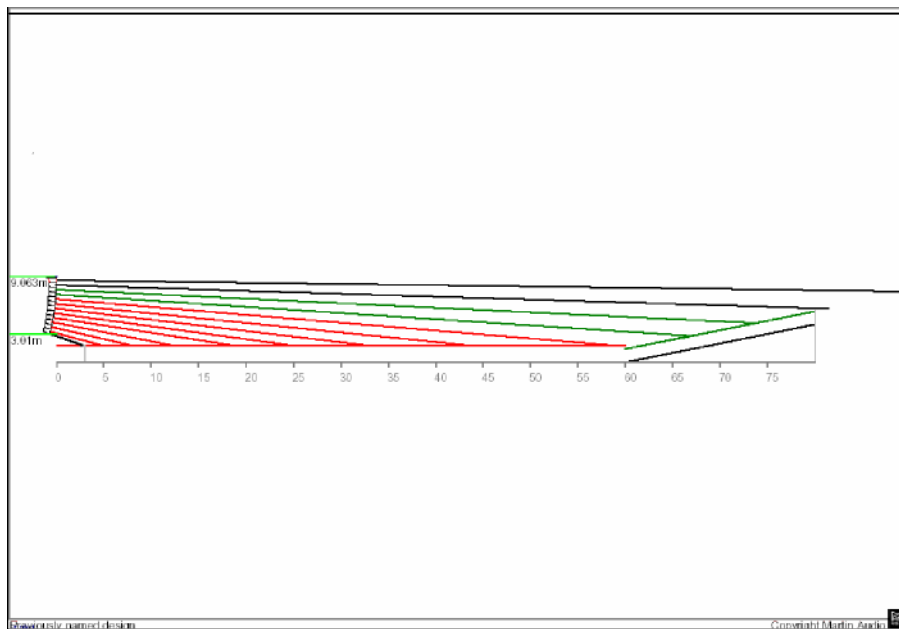

Printing rigging and patch information

Select the *Array* or *Processor* page and click on *Print*.



This will print a sheet showing all the rigging and patch information required to rig and cable an array.

Highest (X) = 9.063 m
Height (Y) = 8.914 m
Height (Z) = 3.009 m

Previously named design

TILT AND SPLAY ANGLES			SPEAKER		CONTROLLER O/P CHAN		
CAB	ANGLE	TYPE	O.P.GROUP	LF	MF	HF	
1+Grid	0.75 H°	W8L	F	1	3	6	
2	1.0 H°	W8L	F	1	3	6	
3	1.0 H°	W8L	E	1	3	6	
4	1.0 H°	W8L	E	1	3	6	
5	1.0 H°	W8L	D	1	3	6	
6	1.0 H°	W8L	D	1	3	6	
7	1.0 H°	W8L	C	1	3	5	
8	1.0 H°	W8L	C	1	3	5	
9	1.0 H°	W8L	B	1	2	5	
10	2.0 H°	W8L	B	1	2	5	
11	2.0 H°	W8L	A	1	2	4	
12	2.0 H°	W8L	A	1	2	4	

***Hole or Slot in rear tilt bar**

Flying Detail - side view

Controller Settings

- Reduced HF EQ - 12V8L HF CUT
- Standard HF EQ - 12V8L HF NORMAL
- Increased HF EQ - 12V8L HF BOOST

LF ch1: 30Hz High pass as default
Set to 20Hz for use without subs

Mechanical : SAFE

Load on Front Pick Point = 733 kg
Load on Rear Pick Point = 896 kg
C.O.G. re. top front corner box 1 = -0.5698 m

Total mass of Array = 1619 kg

Amplifier patch diagram (rear of MA4.2 amp shown)

5.5.20 Closing the program

Select Exit or click on the X symbol in the top right hand corner of the window. You will be prompted to save your work or click Cancel to exit without saving.

5.5.21 ViewPoint Support

Martin Audio Limited is, first and foremost, a loudspeaker manufacturer and we provide software on that basis - to help Martin Audio users get the best performance from our products.

ViewPoint software has been designed for use with selected Martin Audio W8L Series Line Array products only. It is based on accurate W8L Series loudspeaker measurements and is not applicable to other manufacturers' products.

We do not claim to cater for every conceivable W8L Series combination or application but welcome your suggestions that may help improve future products and software.

Request updates or report any operational issues or suggestions by email to:
viewpointsupport@martin-audio.com (Links to email form via IE blank. May take a minute)

5.5.22 Designing systems for deep balconied venues

Typical Question:

My current version of ViewPoint configures the system for a single progressive curvature from the furthest audience area to the front seats.

I am trying to configure a system for a venue with a deep balcony and, therefore, deep under-balcony. I need to make sure that the system covers the rear under-balcony area well because the mix position is there – but I don't want to make the system too loud for the front balcony seats. I don't want to split the array because I want to maintain mid-bass impact.

Answer:

Venues with a deep balcony need arrays with double progressive curvatures. This can be done as follows:

Deep balcony example

The following example is a musical theatre where the distance to the rear of the balcony is similar to the distance to the under-balcony.

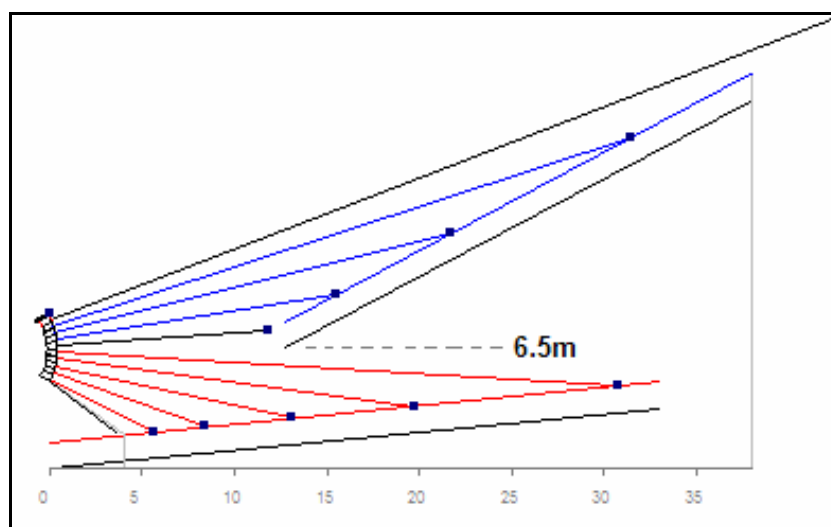

Musical theatre with deep balcony

10 x W8LC per side are available. Front-fills and side fills are used for the first 4m.

Procedure

Although a single array (per side) will be used we can split the array into upper and lower sections – each having its own progressive curvature.

Lower (floor) section

1) Design a system to cover the floor-under-balcony area only - using 5 W8LCs in *Auto* mode. Set the coverage start & stop to cater for the floor coverage required.

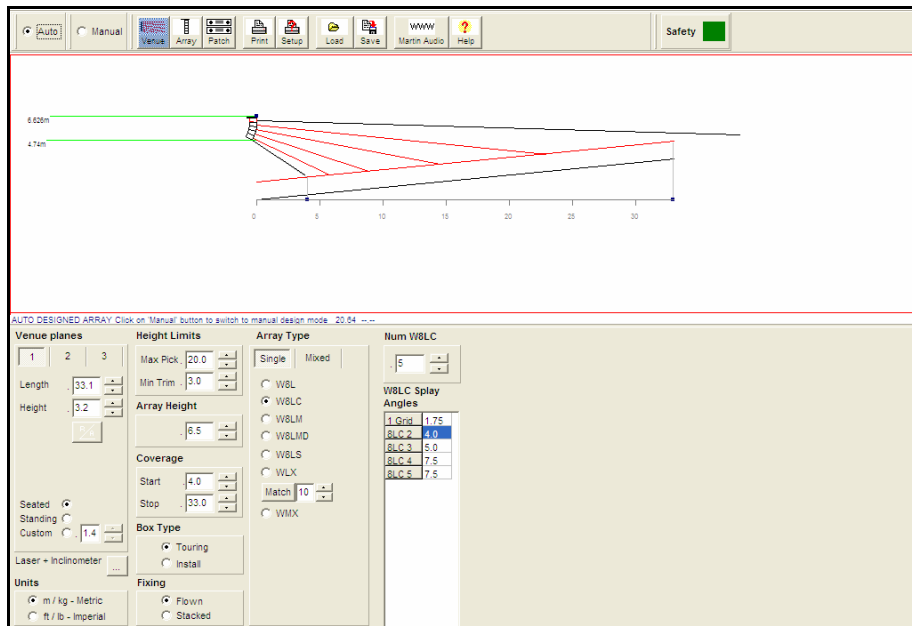

Dual progressive curvature array – lower section only

Set the upper of the five cabinets to the height of the floor at the front of the balcony – point Y on the ViewPoint *Array* page shown overleaf...

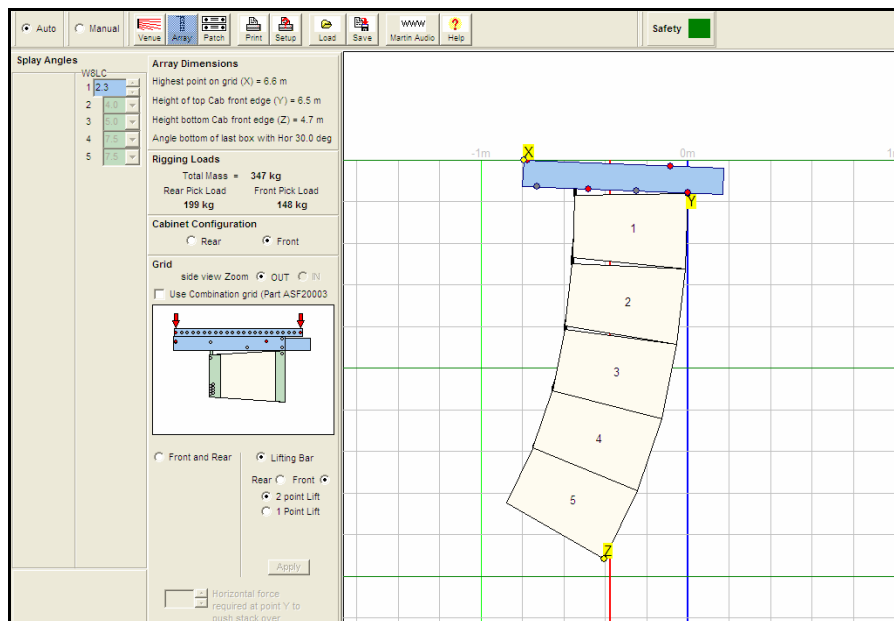

**Dual progressive curvature array – lower section point Y = balcony height (6.5m)
(Make a note of the Z height as well – you'll need this for step 5 later)**

Upper (balcony) section

2) Open a 2nd ViewPoint window and design a system to cover the balcony area only - using the other 5 W8LCs in *Auto* mode. (Use plane 3 and zero the plane 1&2 dimensions)

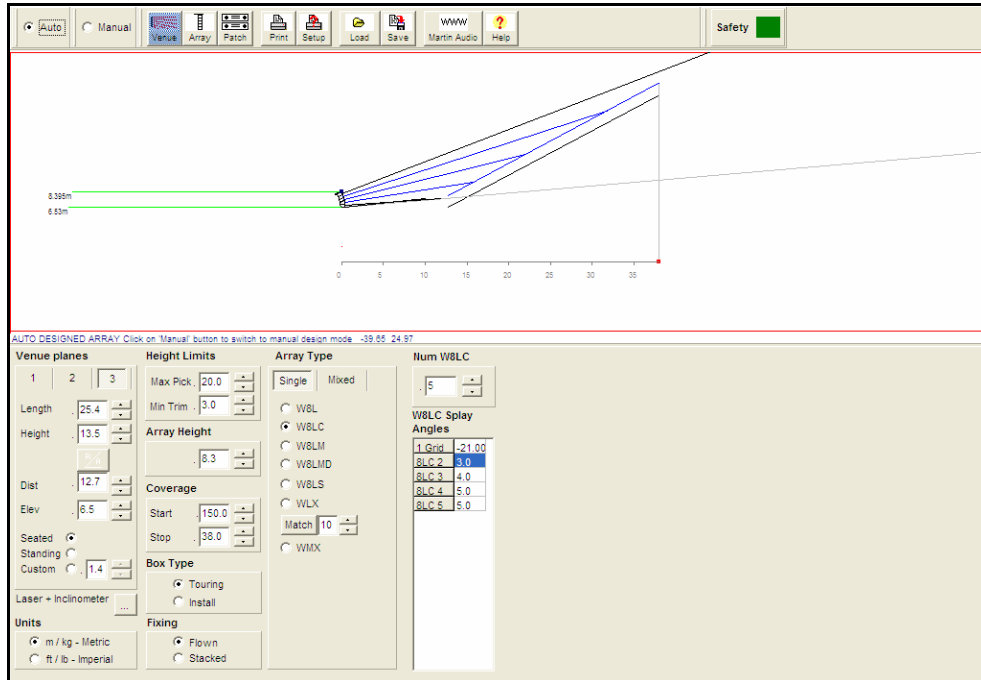

Dual progressive curvature array – upper section only

Set the lower of the five cabinets to the height of the floor at the front of the balcony – point **Z** on the next ViewPoint *Array* page below...

Set the coverage stop to the furthest seat but exaggerate the coverage start until the start line from the bottom of the lower cabinet extends towards the front balcony ear height.

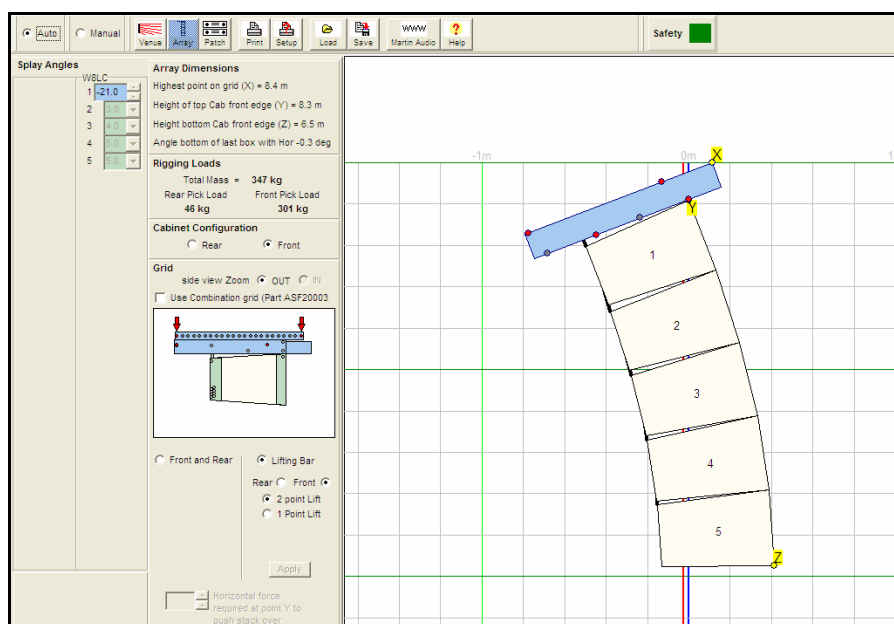

Dual progressive curvature array – upper section point **Z = 6.5m**

Completing the venue and adding the arrays

3) Now take the first (floor only) ViewPoint set-up and add the balcony data from the second one to make a complete venue

- a) Increase the number of W8LCs to 10 (for the complete system)
- b) Set the **coverage start** as set for the floor only and the **coverage stop** as set for the balcony only
- c) Set the array height so that the **lowest (Z) point** is the same as it was for the floor only set-up in step 1)
- d) Switch ViewPoint to **manual** operation and to the **array page**
 - i. Set the lower 5 cabinet angles (7-10) to those used for the previous lower section in step 1)
 - ii. Set angle 6 (the angle between the upper and lower sections) to 7.5°
 - iii. Set the grid tilt and upper 5 cabinet angles (1-5) to those used for the previous upper section in step 2)

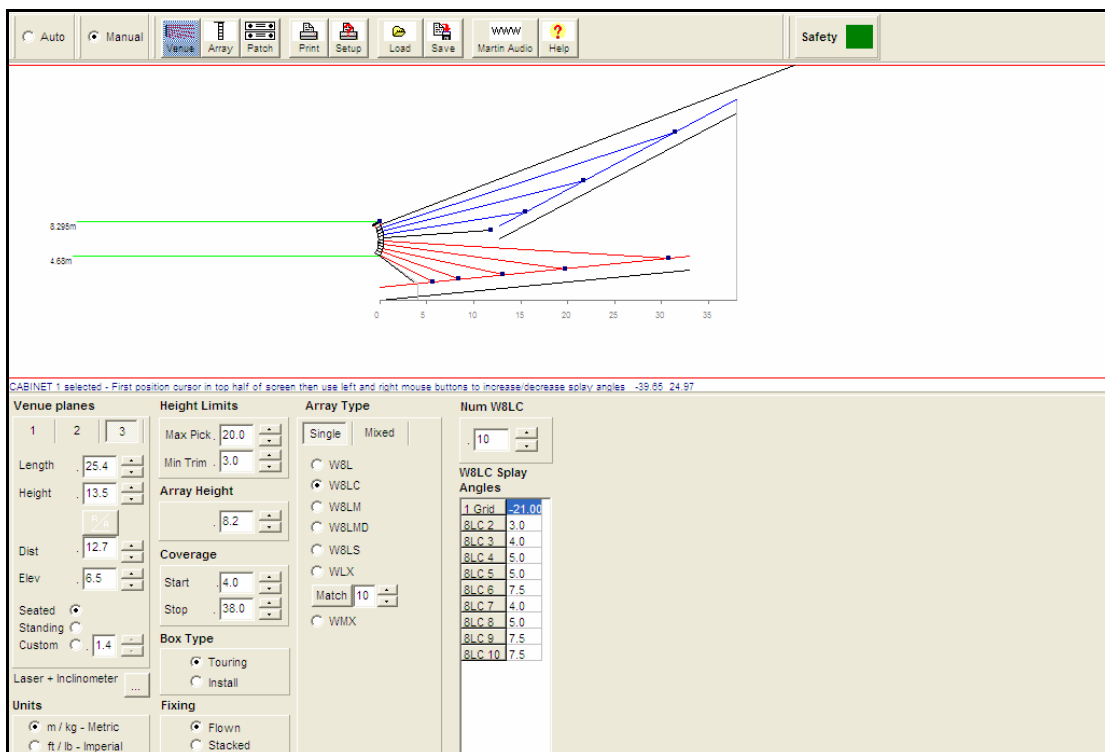

Complete system

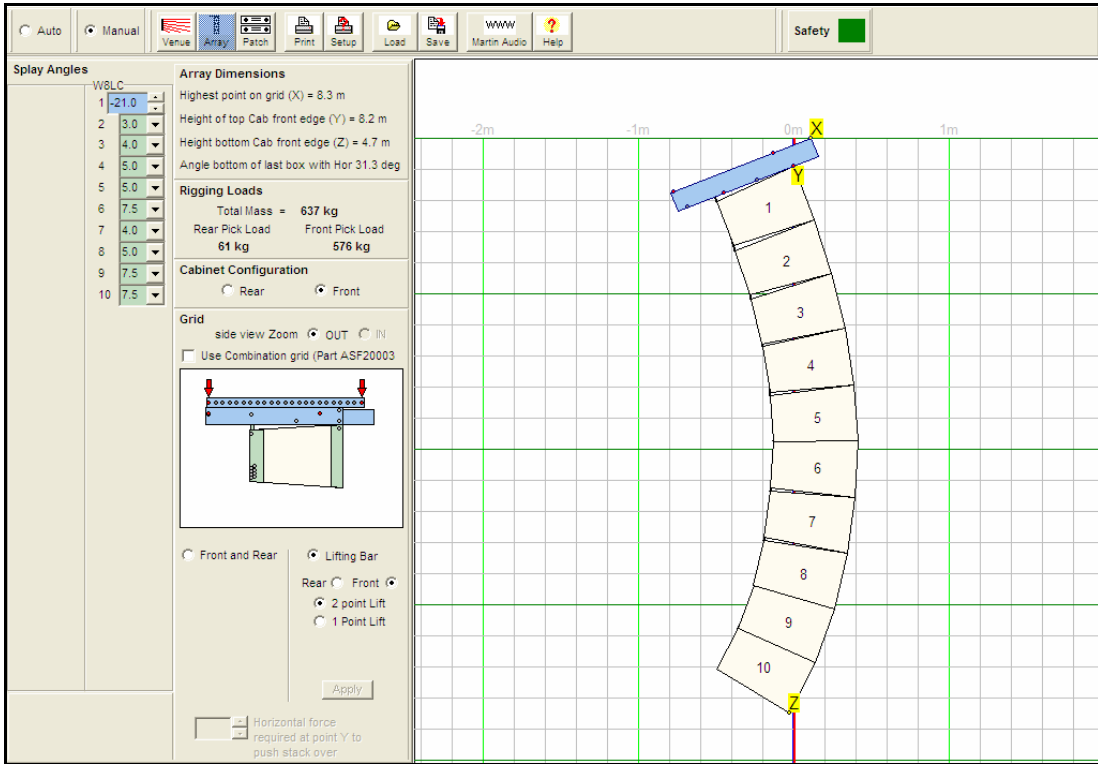

Complete system

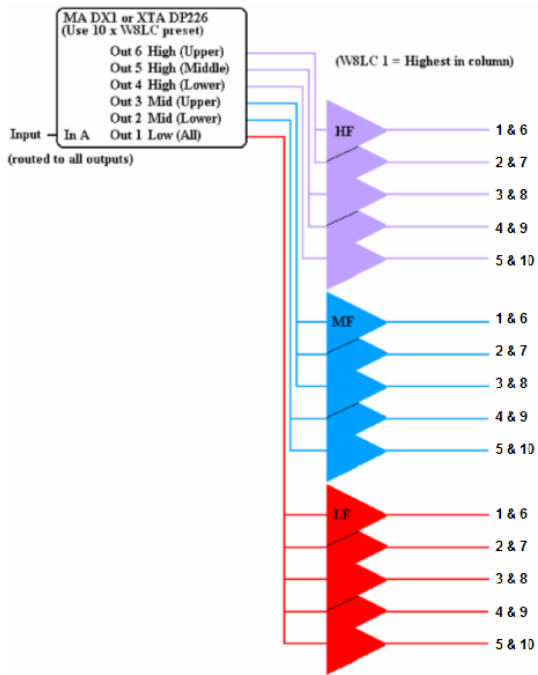

Standard W8LC amplifier rack for 10 x W8LC using standard 10W8LC High Curve preset (Individual lf, mf & hf shown)

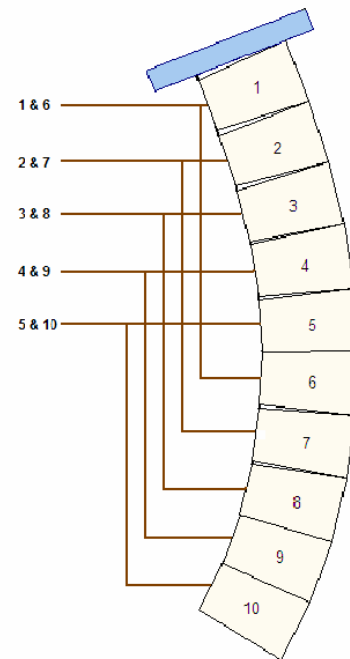

Special speaker array patching (Longer NL8 link leads required!) (3-way cables shown)

5.5.23 System control and Band-zoning

Rack patching

ViewPoint's Processor page recommends suitable controller presets for the line array configuration being plotted. These controller presets ensure that larger line arrays are correctly band-zoned. It is important that racks are correctly patched.



W8L or Longbow amplifier rack patch

Standard W8L Longbow presets configure Martin Audio DX1 or XTA DP226 outputs for the following controller-to-amplifier patches:



DX1 o/p	4xW8L/ Longbow	6xW8L/ Longbow	8xW8L/ Longbow	10xW8L/ Longbow	12xW8L/ Longbow	14xW8L/ Longbow	16xW8L/ Longbow
6 Upper HF			Upper 2 HF	Upper 4 HF	Upper 6 HF	Upper 8 HF	Upper 10 HF
5 Middle HF	Upper 2 HF	Upper 4 HF	Middle 4 HF	Middle 4 HF	Middle 4 HF	Middle 4 HF	Middle 4 HF
4 Lower HF	Lower 2 HF	Lower 2 HF	Lower 2 HF	Lower 2 HF	Lower 2 HF	Lower 2 HF	Lower 2 HF
3 Upper MF		Upper 2 MF	Upper 4 MF	Upper 6 MF	Upper 8 MF	Upper 10 MF	Upper 12 MF
2 Lower MF	All MF	Lower 4 MF	Lower 4 MF	Lower 4 MF	Lower 4 MF	Lower 4 MF	Lower 4 MF
1 All LF	All LF	All LF	All LF	All LF	All LF	All LF	All LF

Note that W8L Longbow and W8LC band zoning is from the bottom upwards as follows:

Mid frequencies

-  Bottom 4 cabinets in the lower zone
-  The rest of the cabinets in the upper zone

High frequencies

-  Bottom 2 cabinets in the lower zone Up to 4 cabinets in the middle zone
-  The rest of the cabinets in the upper zone

W8LC amplifier rack patch

Standard W8LC presets configure Martin Audio DX1 or XTA DP226 outputs for the following controller-to-amplifier patches:

DX1 o/p	4 x W8LC	6 x W8LC	8 x W8LC	10 x W8LC	12 x W8LC	16 x W8LC
6 Upper HF			Upper 2 HF	Upper 4 HF	Upper 6 HF	Upper 10 HF
5 Middle HF	Upper 2 HF	Upper 4 HF	Middle 4 HF	Middle 4 HF	Middle 4 HF	Middle 4 HF
4 Lower HF	Lower 2 HF	Lower 2 HF	Lower 2 HF	Lower 2 HF	Lower 2 HF	Lower 2 HF
3 Upper MF		Upper 2 MF	Upper 4 MF	Upper 6 MF	Upper 8 MF	Upper 12 MF
2 Lower MF	All MF	Lower 4 MF	Lower 4 MF	Lower 4 MF	Lower 4 MF	Lower 4 MF
1 All LF	All LF	All LF	All LF	All LF	All LF	All LF

W8LM amplifier rack patch

W8LM presets 20-39 configure Martin Audio DX1 or XTA DP226 outputs for the following active (as shown) & passive (using low-mid o/p) contr-to-amp patches:

DX1 or DP226 Output	2 x W8LM (Stereo)	4 x W8LM (Stereo)	6 x W8LM (Mono)	8 x W8LM (Mono)	12 x W8LM (Mono)
6	Right High	Right High			Upper 4 High
5	Right Low-mid	Right Low-mid	Upper 2 High	Upper 4 High	Middle 4 High
4	Optional Right Subs	Optional Right Subs	Lower 4 High	Lower 4 High	Lower 4 High
3	Left High	Left High	Upper 2 Low-mid	Upper 4 Low-mid	Upper 8 Low-mid
2	Left Low-mid	Left Low-mid	Lower 4 Low-mid	Lower 4 Low-mid	Lower 4 Low-mid
1	Optional Left Subs	Optional Left Subs	Optional Subs	Optional Subs	Optional Subs



Alternative W8LM +WLX presets (40-49) are now available. These provide active W8LM settings with a separate sub woofer signal chain via input B and output 6:

DX1 or DP226 Input	DX1 or DP226 Output	6xW8LM+WLX (Mono)	8xW8LM+WLX (Mono)	12xW8LM+WLX (Mono)
B	6 Subs (Default = WLX)	WLX	WLX	WLX
A	5 Upper High			Upper 4 High
A	4 Middle High	Upper 2 High	Upper 4 High	Middle 4 High
A	3 Lower High	Lower 4 High	Lower 4 High	Lower 4 High
A	2 Upper Low-mid	Upper 2 Low-mid	Upper 4 Low-mid	Upper 8 Low-mid
A	1 Lower Low-mid	Lower 4 Low-mid	Lower 4 Low-mid	Lower 4 Low-mid



Band Zoning

W8LM band zoning is from the bottom upwards as follows:

Low-mid frequencies

-  Bottom 4 cabinets in the lower zone
-  The rest of the cabinets in the upper zone

High frequencies

-  Bottom 4 cabinets in the lower zone
-  Up to 4 cabinets in the middle zone
-  The rest of the cabinets in the upper zone

Controller presets

Your Martin Audio DX1 or XTA DP226 controllers must be loaded with the correct system preset files before use. See next section ...

Output limiters

Please note that all W8L Series controller output limiters are set for a power amplifier gain of 32dB (x40). **DO NOT USE AMPLIFIER CLIP ELIMINATORS OR LIMITERS!**

Important: *If you wish to use power amplifiers with different output/input gains please make sure you compensate by adjusting the limiter setting.*

Decrease limiter settings by 1dB for every 1dB increase in amplifier gain.

Loading W8L Series presets into your Martin Audio DX1 or XTA DP226



Presets are regularly updated.

Locate the latest DX1 or XTA DP226 software in the [Controller Presets](#) section of the latest *User Guides CD* and follow the instructions carefully

A *User Guides CD* will have been included in every product carton supplied by Martin Audio. If your loudspeakers arrived without them please contact your supplier for a copy.

You will need a 9 pin male-to-female RS232 cable (not the null modem type) if you wish to load binary presets from your pc into your Martin Audio DX1 or XTA DP226 controller.

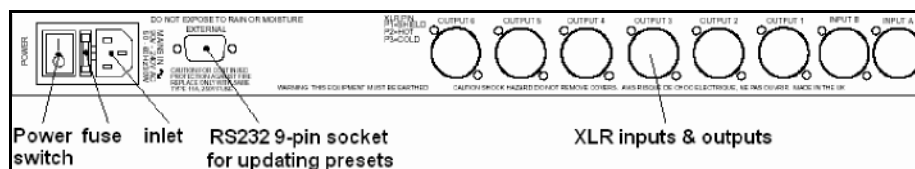

Very important warning:

Although loading new Martin Audio factory presets will not override your personally saved user settings, the new presets will overwrite previous factory presets and the Martin Audio DX1 or XTA DP226 will be dedicated to W8L Longbow, W8LC or W8LM use only depending on which .bin file has been loaded.

Make sure you have a copy of the latest User Guides CD available before starting this process so that you can reload the previous data if you need to.

Do not try to load Martin Audio (MARR) presets into an XTA DP226 or vice versa as this will render the controller unusable until it is repaired.

5.6 Horizontal considerations

Horn-loaded mid frequency system advantage

W8L Series mid frequency elements have been designed with true constant directivity horns for excellent wide-band horizontal pattern control over a wide coverage angle.

Many line array manufacturers cut their costs by ignoring the superior coverage pattern control good horn designs can provide. They use direct radiating mid-range devices instead - incorporating cross-firing techniques to try to emulate coverage control. These cross-fired midrange drivers can create two acoustical problems. They do not combine to produce consistent mid frequency coverage and they disturb the HF mouth shape destroying HF coverage consistency.

Narrow venues

Where line array loudspeakers are to be used in narrow venues we normally recommend placing them in stereo with left and right paths crossing towards the rear of the venue.

There is a trade off between stereo coverage and far-field sound pressure level. Crossing paths at the rear of the venue gives maximum summation for maximum spl at the rear centre.

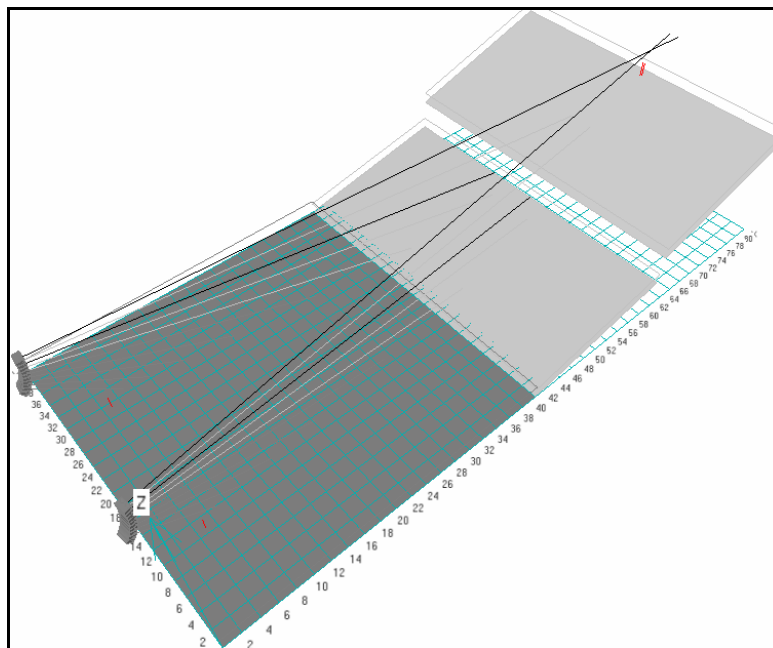

DISPLAY™ view showing stereo set-up in narrow venue

Crossing paths about 2/3 up the venue gives a wider stereo footprint nearer the front. Note that left and right are cross-fired for rear corner audiences. This can help avoid the ping-pong effect of hearing all left or all right. Cross-firing has to be used with care though. Signal doubling may be heard between the rear corners and the sides if the left-right path lengths differ by more than 30mS

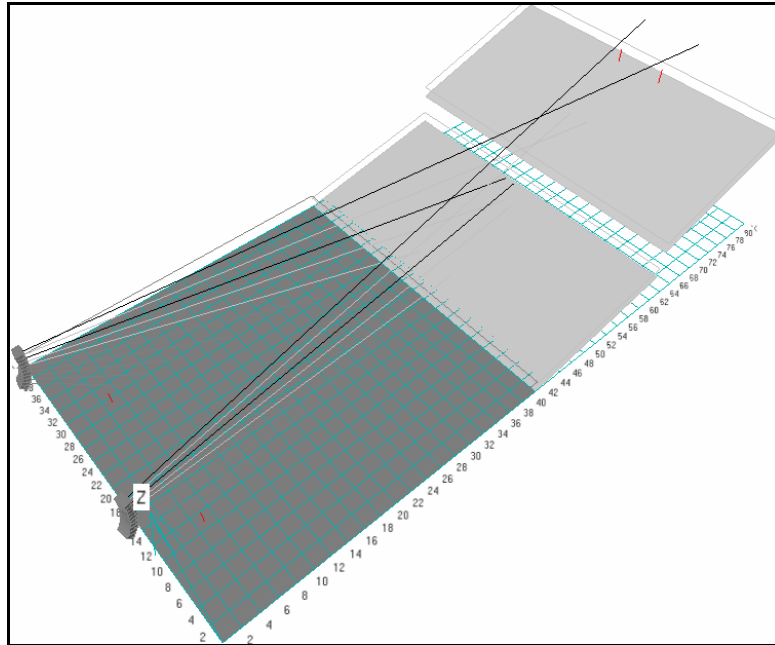

Cross-fired stereo set-up in narrow venue

Wide venues

Where line arrays are required to cover wider venues they may be opened out to aim almost straight down the room for $\pm 45^\circ$ coverage or even opened out a few degrees.

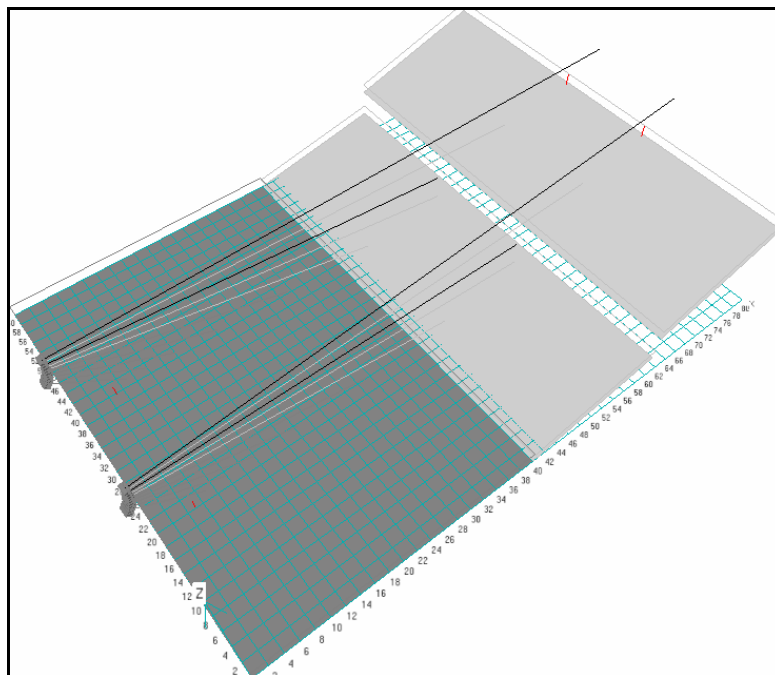

L-R system aimed almost straight down wide room

Note that columns aiming straight out will have a much narrower stereo coverage than arrays that are aimed inwards slightly. Operators should bear this in mind and keep mixes semi-mono.

Multiple W8L series arrays

Well designed line arrays provide very consistent horizontal coverage right up to very high frequencies. W8L series arrays may be placed up to 90° apart to extend horizontal coverage for very wide venues. Inner sections should be aimed in by a few degrees for good stereo coverage at the mix position.

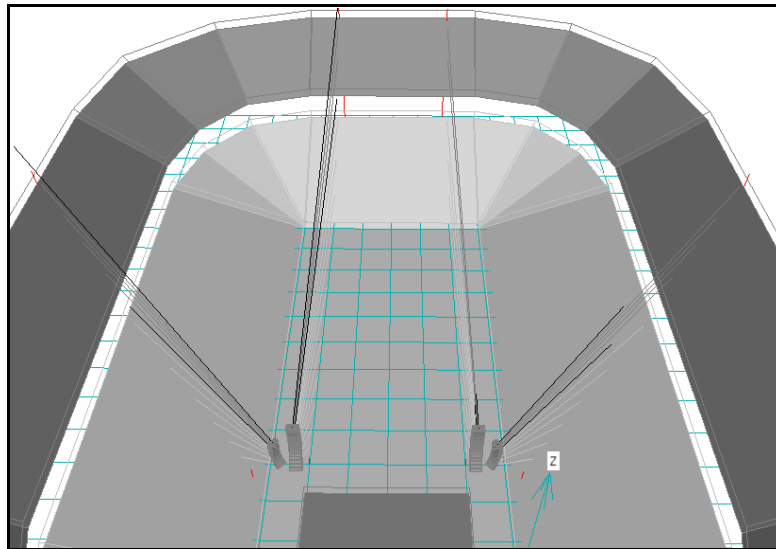

DISPLAY™ view of multiple W8L series arrays

Outer and inner systems may be different members of the W8L series depending on the relative distances to be covered and the rigging point ratings available.

Very wide venues

Note that pairs of W8L series arrays may be horizontally splayed by up to 90° for very wide coverage with minimal gain between arrays. The Martin Audio heritage of W8L series loudspeakers gives them that typical Wavefront arrayability. No special spacing is required. Simply ensure that the adjacent bottom rear corners are within 30cm.

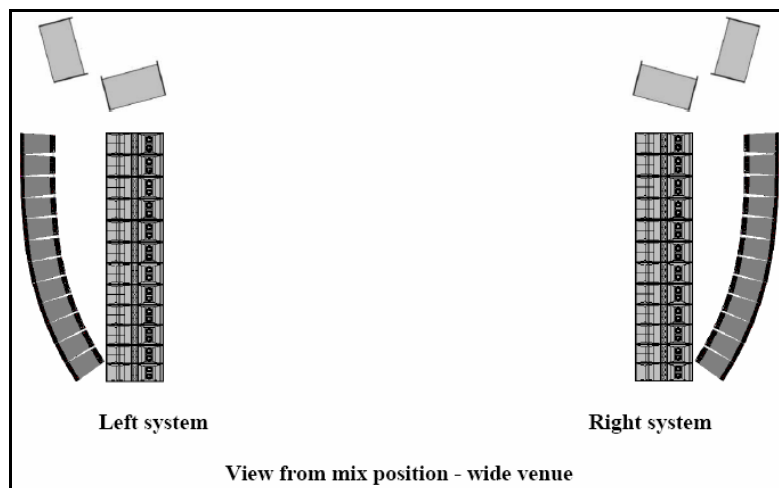

Smaller horizontal splay angles will tend to provide horizontal mid-band summation in the far field. For instance, 45° between adjacent arrays will boost the inter-array area by approximately 3dB. This can help the vocal projection to the far corners of arenas.

Matching array curvature

When specifying a system for very wide venues, try to keep inner and outer columns lengths and shapes similar for a given vertical coverage. If you don't have enough large cabinets to cater for everything, you can normally mix and match different W8L series systems as follows:

For instance, 16 x W8LC outers will match 12 x W8L Longbows for the same vertical coverage in a large venue or 15 x W8LM outers will match 10 x W8LC inners for the same vertical coverage in a smaller venue. This will provide smooth inner-to-outer transition.

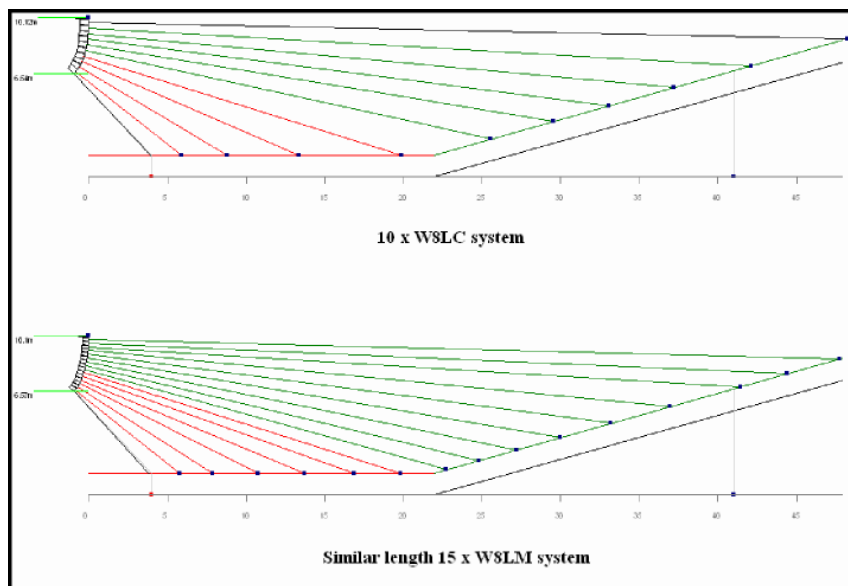

Similar length and shape arrays – but different W8L series – for the same coverage

Short stretch systems

A short stretch system is often all that is required to increase the main system's horizontal coverage beyond the normal pattern control of a main W8L series line array to cover extra upper side seats.

It is common practice to use a short array that matches the upper section of the main inner array. This is then flown fly at the height to the main array to cover, for instance, upper arena side seats.

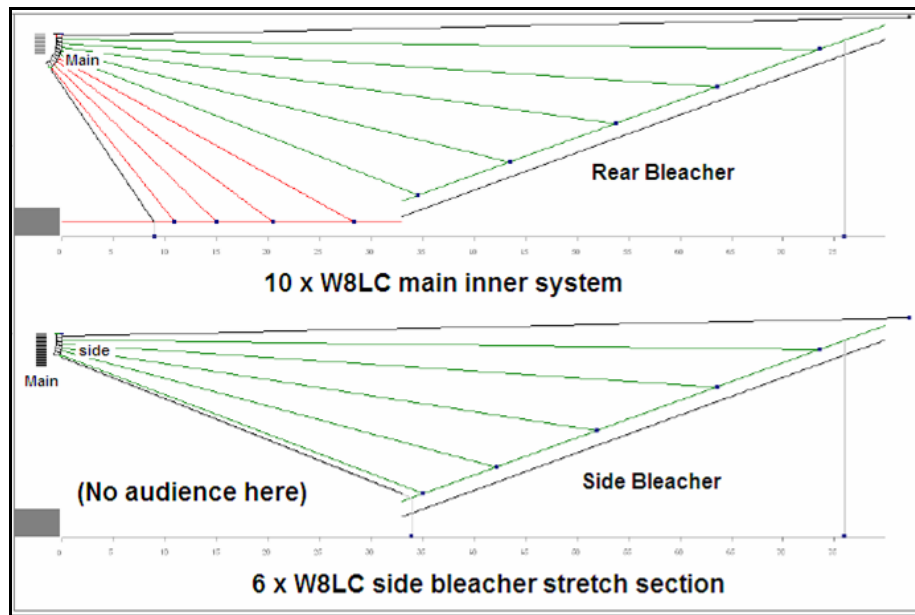

Main system (upper) with matching short side stretch array (lower)

5.7 Subwoofers and front fills

5.7.1 Subwoofer crossover and alignment

Crossover frequencies

Recommended W8L series high pass (low cut) filters are as follows:

Loudspeaker Type	Factory preset default	Full-range (without subs)
W8L Longbow	35Hz 24dB/8ve L-R	25Hz 24dB/8ve L-R
W8LC, W8LD or W8LCD	60Hz 24dB/8ve L-R	30Hz 24dB/8ve L-R
W8LM or W8LMD	70Hz 24dB/8ve L-R	30Hz 24dB/8ve L-R

Different combinations of W8L series line arrays (including down-fills) and commonly used subwoofers require accurate alignment. Optimum initial delay offsets will depend on the type of subwoofer to be used. For instance, direct radiating subwoofers usually need to be delayed back to horn-loaded W8LC, W8LCD, Longbow or W8LD loudspeakers whereas most W8L series full-range line arrays will need to be delayed back to larger horn-loaded subs like the WSX and the WLX.

Optimum crossover frequency settings will also vary depending on the combination. Horn-loaded line array LF sections may be overlapped with horn-loaded subwoofers to increase mid-bass headroom and projection whereas a more defined crossover without a wide overlap is required to combine horn-loaded line array LF sections with direct radiating subs because they have different phase vs frequency responses.

Please print off the chart on the following page and attach in inside the back of your subwoofer racks for reference.

It is very important for you to start off with these reference settings before attempting to time align your system for any physical misalignment.

Line array to subwoofer delay table Feb 2007

W8L sub delay table										BSS	XTA	Limiters	Attack time	
Driver	Delay (grilles aligned)	Gain	Phase	X-Over HPF	LR=Linkwitz Riley Slope	LPF	Slope	Eq Freq.		(Width/Oct)	(Q)	Gain	(MA4.2)	(release=x16)
W8L	15"	0ms	**	In	60Hz	24dB/Oct	230Hz	24dB/Oct	54.6Hz	1	1.4	+4dB	+7dBu	16ms
WSX	18"	0ms	0dB	In	20Hz	24dB/Oct	80Hz	24dB/Oct	37.2Hz	1.15	1.2	+4dB	+7dBu	45ms
W8L	15"	0ms	**	In	60Hz	24dB/Oct	230Hz	24dB/Oct	54.6Hz	1	1.4	+4dB	+7dBu	16ms
W8LS/WS218X	2x18"	5.5ms	0dB	In	20Hz	24dB/Oct	80Hz	24dB/Oct	35.1Hz	1	1.4	+6dB	+7dBu	45ms
W8L	15"	0ms	**	In	60Hz	24dB/Oct	230Hz	24dB/Oct	54.6Hz	1	1.4	+4dB	+7dBu	16ms
WLX	18"	2.75ms	0dB	In	20Hz	24dB/Oct	80Hz	24dB/Oct	40Hz 70Hz	0.85 0.3	1.7 5	+5dB +2dB	+7dBu	45ms
W8LC sub delay table														
Driver	Delay (grilles aligned)	Gain	Phase	X-Over HPF	LR=Linkwitz Riley Slope	LPF	Slope	Eq Freq.		(Width/Oct)	(Q)	Gain	(MA4.2)	(release=x16)
W8LC	12"	2.5ms LF (4.601 MF, 4.562 HF)	**	In	60Hz	24dB/Oct	270Hz	24dB/Oct	54.6Hz 154Hz 223Hz	0.5 0.35 0.7	3 4 2	+5dB -6dB +3dB *	+5dBu	16ms
WSX	18"	0ms	0dB	In	20Hz	24dB/Oct	80Hz	24dB/Oct	37.2Hz	1.15	1.2	+4dB	+7dBu	45ms
W8LC	12"	0ms	**	In	60Hz	24dB/Oct	270Hz	24dB/Oct	54.6Hz 154Hz 223Hz	0.5 0.35 0.7	3 4 2	+4dB -6dB +3dB *	+5dBu	16ms
W8LS/WS218X	2x18"	4.0ms	0dB	In	20Hz	24dB/Oct	80Hz	24dB/Oct	35.1Hz	1	1.4	+6dB	+7dBu	45ms
W8LC	12"	0.75ms LF (2.851 MF, 2.812 HF)	**	In	60Hz	24dB/Oct	270Hz	24dB/Oct	54.6Hz 154Hz 223Hz	0.5 0.35 0.7	3 4 2	+4dB -6dB +3dB *	+5dBu	16ms
WLX	18"	0ms	0dB	In	20Hz	24dB/Oct	80Hz	24dB/Oct	40Hz 70Hz	0.85 0.3	1.7 5	+5dB +2dB	+7dBu	45ms
W8LM sub delay table														
Driver	Delay (grilles aligned)	Gain	Phase	X-Over HPF	LR=Linkwitz Riley Slope	LPF	Slope	Eq Freq.		(Width/Oct)	(Q)	Gain	(MA4.2)	(release=x16)
W8LM	2x8"	5.932ms LF (5.831 HF)	**	In	70Hz	24dB/Oct	2k12	24dB/Oct	90Hz See W8LM spreadsheet for rest of EQ	1.15	1.2	+6dB	+5dBu	16ms
WSX	18"	0ms	0dB	In	20Hz	24dB/Oct	80Hz	24dB/Oct	37.2Hz	1.15	1.2	+4dB	+7dBu	45ms
W8LM	2x8"	0.101ms LF (0ms HF)	**	In	70Hz	24dB/Oct	2k12	24dB/Oct	90Hz See W8LM spreadsheet for rest of EQ	1.15	1.2	+6dB	+5dBu	16ms
W8LS/WS218X	2x18"	0ms	0dB	In	20Hz	24dB/Oct	80Hz	24dB/Oct	35.1Hz	1	1.4	+6dB	+7dBu	45ms
W8LM	2x8"	3.932ms LF (3.831 HF)	**	In	70Hz	24dB/Oct	2k12	24dB/Oct	90Hz See W8LM spreadsheet for rest of EQ	1.15	1.2	+6dB	+5dBu	16ms
WLX	18"	0ms	0dB	In	20Hz	24dB/Oct	80Hz	24dB/Oct	40Hz 70Hz	0.85 0.3	1.7 5	+5dB +2dB	+7dBu	45ms
W8LM	2x8"	3.502ms LF (3.401 HF)	**	In	70Hz	24dB/Oct	2k12	24dB/Oct	90Hz See W8LM spreadsheet for rest of EQ	1.15	1.2	+6dB	+5dBu	16ms
WMX	18"	0ms	0dB	In	20Hz	24dB/Oct	80Hz	24dB/Oct	40Hz 70Hz	0.85 0.3	1.7 5	+5dB +2dB	+7dBu	45ms
Note: MA4.2 amp set to 32dB gain MA2.8 amp recommended for W8LC and W8LM. Limit levels are the same as above														
Adjust channel gain of sub to equalise LF output with W8L, W8LC or W8LM system The gain value is dependant on numbers of full range cabinets, numbers of subs, flown or ground stacked configuration														
* +2dB for 12xW8LC ** SEE SPREADSHEET FOR THAT LINE ARRAY PRODUCT														
All material © 2007 Martin Audio Ltd. Subject to change without notice.														

W8L, W8LC and W8LM inter-driver delays

Standard Martin Audio presets apply small output channel delays to DX1 or DP226 controllers to align the multiple drivers within W8L, W8LC and W8LM cabinets.

These inter-driver delays are not user adjustable. They have a strong influence on a system's off-axis lobe structure in addition to the usual on axis performance alignment.

Very important note!

Crossover frequency and phase settings should never be adjusted to compensate for room anomalies.

Controller input equalizers or external equalizers (or, in an ideal world, room treatment!) should be used for that purpose.

Controller Reference Delays

The multiple driver delays in standard Martin Audio presets are “Lock Linked” to a particular crossover reference delay channel. In the absence of any main (W8L, W8LC) delay requirement, the W8L and W8LC reference delays default to zero because they relate to the LF horn drivers whose acoustical centre is furthest from the cabinet grille – i.e. the driver that every other driver in the cabinet gets delayed to.

W8LM presets include the WLX sub woofer so they have two (mono) or four (stereo) unlocked delays. The WLX channel defaults to zero because the WLX has the longest horn. The W8LM LF/Full-range and HF reference delays default to 3.931mS and 3.829mS respectively to time align the W8LM to the WLX when the grilles are aligned.

W8L, W8LC & W8LM reference delays and subwoofer delays are left unlocked to allow users to align main systems and sub woofers if placement causes misalignment. The “Lock Linking”, mentioned above, ensures that all the drivers in a cabinet track the reference delay and maintains the correct inter-driver alignment.

Standard reference delay channels are shown on the next page...

W8L Series	Reference delay channels (left unlocked for main-to-subwoofers alignment)	Functions
W8L Longbow	1	LF
W8LC	1	LF
W8LM (Active mono)	<i>1</i> 4	<i>WLX</i> Lower HF
W8LM (Passive mono)	<i>1</i> 2	<i>WLX</i> Lower full-range
W8LM (Active stereo)	<i>1</i> 3 4 6	<i>Left WLX</i> Left HF <i>Right WLX</i> Right HF
W8LM (Passive stereo)	<i>1</i> 2 4 5	<i>Left WLX</i> Lower left full-range <i>Right WLX</i> Lower right full-range

Alternative W8LM + WLX presets are now available. These provide a separate subwoofer signal chain via controller input B and output 6. Reference delays for these main+sub input set-ups are as follows:

W8LM + WLX	Reference delay channels (left unlocked for main-to-subwoofers alignment)	Functions
4W8LM + WLX (Active mono - configured upper & lower for possible flown + stacked use)	6 3 4	<i>WLX</i> Lower HF Upper HF
6/8/12W8LM + WLX (Active mono)	6 4	<i>WLX</i> Lower HF

Subwoofers usually take their signal from a separate controller for W8L Longbow and W8LC systems because our standard band zoned presets use all six bands.

The WLX subwoofers signal will be on controller output channel 1 for standard W8LM set-ups. The WLX signal will be on channel 6 where a separate subwoofer mix is to be used using a W8LM + WLX configuration.

Compensating for physical misalignment

Similar length sub woofer arrays should be placed beside the main system for consistent performance and maximum impact throughout the audience area.

Subwoofers may be flown above or beside main systems (using the appropriate W8L Series flying systems or adaptors) or they may be stacked on the floor. Smaller main systems may be stacked on top of the subwoofers with good results.

If systems *have* to be physically misaligned, when subwoofers are ground stacked in front of a stage wing for instance, extra delay may be employed to compensate for the differing arrival times.

Please note:

Electronic delay can only compensate for physical misalignment with reference to a specific listening area - usually a listening reference point e.g. the mix position. In the following example, aligning for maximum impact at the mix position will compromise bleacher impact and vice versa.

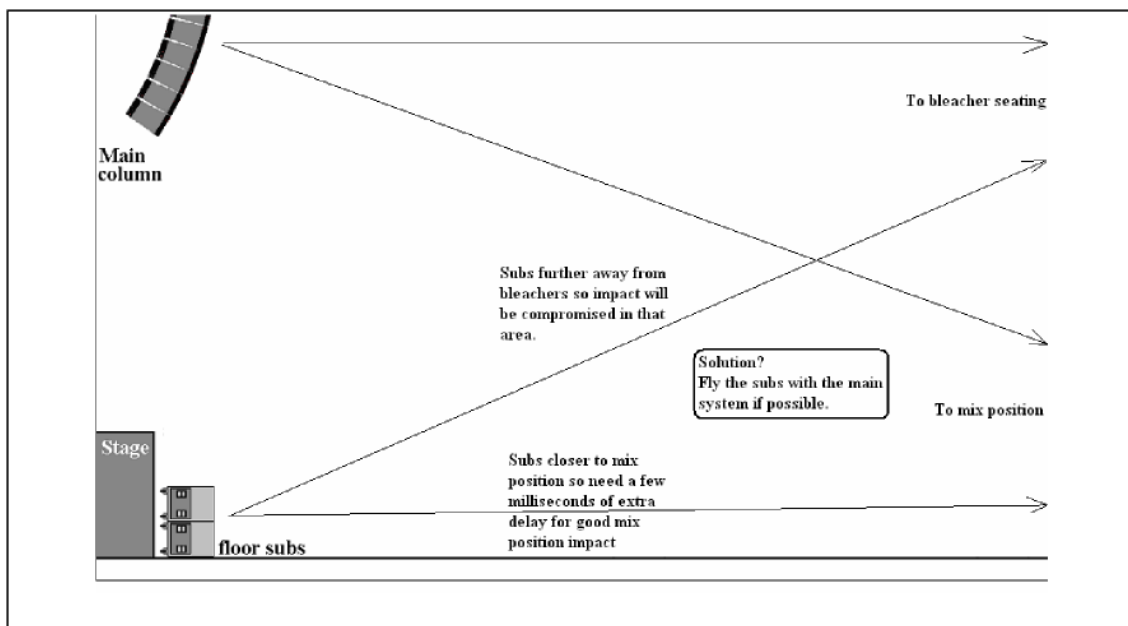

Subwoofers may be time aligned without sophisticated test gear as follows:

- 1) Start with the recommended initial controller settings – see previous table
- 2) Use a laser tape measure to measure the distance to the main system grille and the subwoofer grille
- 3) If the subwoofers are closer than the main system, increase the subwoofer system controller delay (Use 2.91ms for every meter of misalignment). If the main system is closer than the subwoofers, increase the main system delay
- 4) Fine adjust the delay to compensate for boundary conditions (*see explanation on next page*) using the null method - switch the subwoofers to reverse polarity, and listen to a 70Hz tone on the main system & subs from the mix position. Fine trim the delay for a dip in level.
(*Note that you must complete items 1 to 3 before starting item 4 or you could end up with a system that is misaligned by a complete wavelength at 70Hz!*)
- 5) Don't forget to switch the subwoofers back to normal polarity for maximum summation and impact!

Boundary conditions

When sub woofers are placed on or near a floor, wall, ceiling, solid stage apron etc., these solid surfaces form a boundary that can restrict or reflect a significant portion of the subwoofers' off-axis radiation.

Some of these boundaries will inevitably reflect this off-axis radiation back towards the audience – but with a small time delay. The audience will hear a combination of direct and reflected sound which, if the direct and reflected paths are within $\frac{1}{2}$ a wavelength of each other, will tend to add positively – but with a slight phase lag caused by the delayed reflective component.

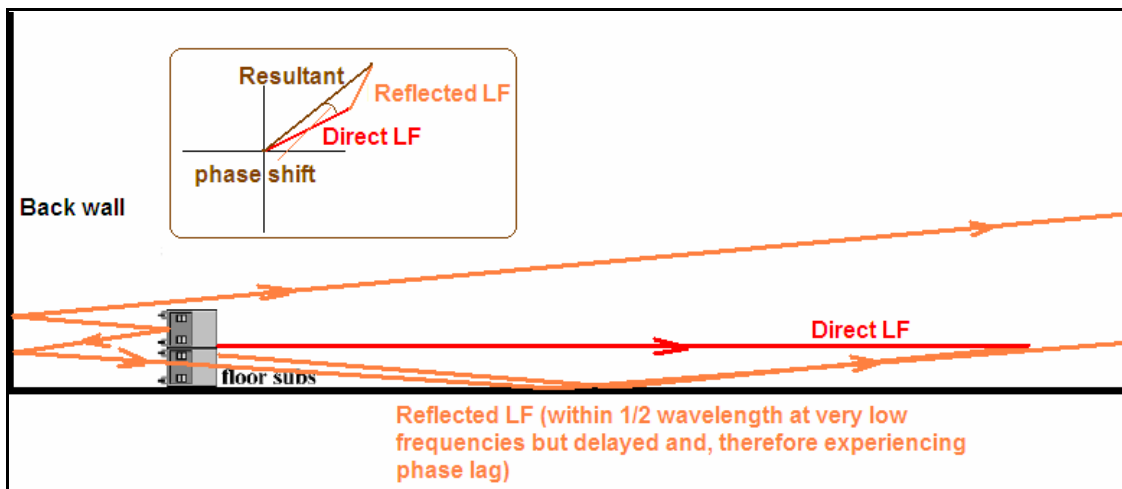

The above illustration shows an inset polar diagram with the direct LF (red) summing to a lower magnitude - and phase shifted – reflected LF (orange). The resultant direct + reflected signal (brown) is higher in magnitude but rotated anti-clockwise to indicate a phase lag.

This phenomenon makes precise subwoofer alignment difficult – especially if the main line array system and the sub woofers are affected by different boundary conditions or adjacent systems.

The ***null method*** recommended on the previous page assumes that the main arrays and sub woofers are set-up using the recommended crossover presets and that they have been time aligned to compensate for any distance offset. It works on the basis that two sources (the line array and the subs) will cancel each other in the crossover region if switched to opposite polarities – but only if perfectly time aligned. Once the main-to-sub array delay has been fine adjusted to create a null, the polarity reverse is cancelled so that the two systems sum in phase.

Note that, although cardioid subwoofers produce less radiation directly to the rear, they are still affected by floor and wall boundaries and fine alignment is still necessary.

5.7.2 Front fill placement and alignment

Placement

Other loudspeakers in the Wavefront range may be used as stage apron fills to augment W8L Series line array systems.

When positioned on a radius from the downstage centre vocal area and synchronised with the lower line array section, these apron fills don't just balance the sub woofers. They focus vocals and add a detailed quality that can be beneficial right out to the mix position.

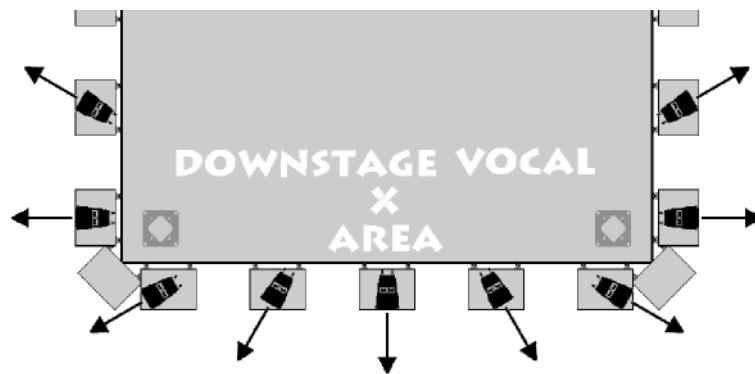
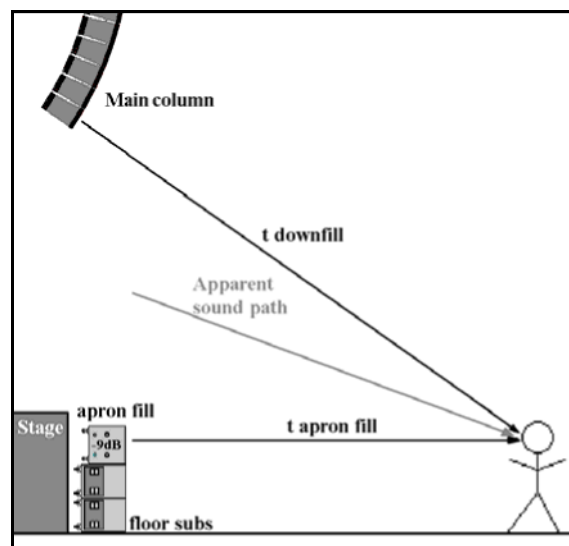

Image alignment

If the apron fill signal is delayed by the difference between the down-fill propagation time and the apron fill propagation time and attenuated by the ratio of those propagation times, the sound will appear to come from an area in between the two systems for the listener shown.



- Apron fill delay line setting = $t_{\text{down-fill}} - t_{\text{apron fill}}$ (2.91ms for each metre)
- Set apron fill gain so that image appears to come from artist's position

5.8 Climatic Effects

Introduction

When working in large venues or outdoors we should always remember that sound propagates through air and is affected by air temperature, humidity and wind.

The most audible of these effects is wind as it can vary dramatically in less than a second causing rapidly swept filter effects that change middle and high frequency content into incoherent noise.

Air temperature can change suddenly with very audible effects (eg when backstage doors are opened during sound checks, venue doors are opened near the end of a show in winter or cold air displaces the warm air trapped in a stadium during a clear summer evening). Although quite rare, rapid air temperature changes can cause sudden changes in propagation direction and major coverage problems for a few fretful minutes before clearing. These sudden coverage changes often trigger sound system investigations as they can sound like loudspeaker or amplifier failures.

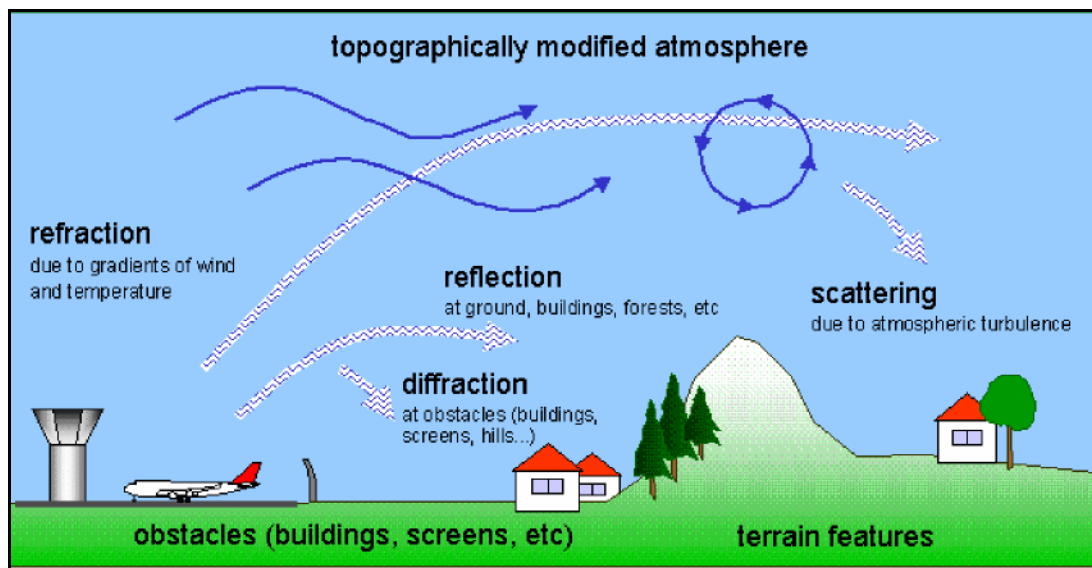

Humidity tends to change slowly with time and affects the higher frequencies. This slow change can be missed as our ear-brain systems tend to compensate for subtle high frequency losses. If the relative humidity changes from, say, 25% at the beginning of a hot afternoon's sound check to 40% as the weather turns sultry, we may not notice the gradual 6dB increase in high frequency at the back of the field (3dB at the mix position) until the guest engineer arrives, having walked the field with a clean* pair of ears, and wants to change everything.

*Be aware that the human ear discharges more wax in humid conditions and this will tend to negate the improved high frequency propagation.

Temperature and wind gradients

The effects of temperature and wind gradients are most noticeable when sound systems are used outdoors, although not limited to this case. They exist when there are differences between the temperatures or wind speeds of layers of air from the ground upwards. The most common effect is to steer high frequencies away from the direction that the loudspeakers are pointing. Typically if the ground is hot compared to the air above or the wind is blowing from audience to stage, then sound will be steered upward and conversely if the ground is colder or the wind is blowing from stage to audience then sound will be steered downward.

Temperature and wind gradients are difficult to measure yet their effects can have dramatic consequences for live sound projection. For this reason it is advisable to use delay systems to suit the expected humidity conditions. See table at the end of this section.

Wind effects

Prevailing Winds

Winds will increase sounds downwind from a source and reduce them upwind. This is not solely a result of the velocity effect, but also because the spherical wave-front is deformed by the prevailing wind.

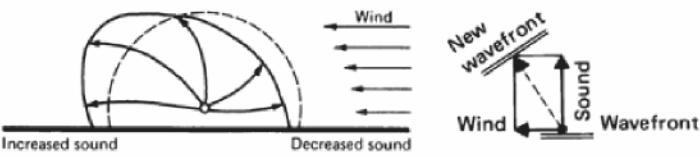

The resulting radius of curvature of the sound rays can be derived as follows;

$$1/R = (((10T)^{1/2})(dT/dz) + (du/dz)) / (c(1 + uc)^2)$$

where R is the radius of curvature (m), T is the temperature (K), z is the elevation (m), c is the speed of sound (m/s) and u is the wind speed vector in the direction of propagation (m/s).

Side winds

Gusting side winds can dramatically effect mid and high frequency sound by changing the propagation direction as follows:

Single sound source

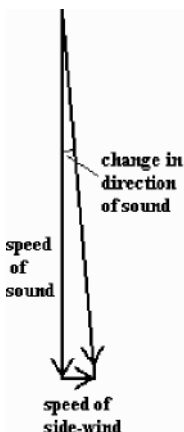

Change in sound direction = $\arctan \frac{\text{speed of side-wind}}{\text{speed of sound}}$

(arctan = "the angle whose tangent is...")

For example a 50km per hour (31 mph) side gust = approx 13.9m/s.
 The temporary change in direction during the gust = $\arctan 13.9/340$
 = approx $\arctan 0.041$ = approx 2.3°

This may seem trivial until you realise that this sudden 2.3° change will shift a poorly arrayed system's polar pattern undulations about 2m to right at a typical outdoor mix position enough to swap high-mid and high frequency peaks and troughs several times in just a few seconds.

Variable combing (phasing) caused by wind effects should be minimised by avoiding widely spaced, parallel high frequency sections carrying the same signals.

Spaced, parallel loudspeakers will comb (add or subtract their outputs) depending on their distance or time offset from us. A 150mm/0.5ms offset at the listening position will cause nulls at 1KHz, 3KHz, 5KHz, 7KHz, 9KHz, 11KHz etc but we wouldn't be aware of the combing under casual listening conditions because we are used to listening to natural sounds in the presence of multiple arrivals (echoes) and our ear-brain system adapts to it. We don't adapt to *varying* comb structures though, especially in the horizontal plane, as our horizontally spaced ears act as a sensitive interferometer.

Where budgets allow, mono centre columns should be used for lead vocals and instrumentals. Large ensembles (such as large string sections or large choirs) should be divided into multiple subgroups which are sent to separate clusters.

Wind gradients

Air movement is slowed by friction so wind is usually lighter near the ground than it is higher up. Ground level wind speeds can vary from over 90% of the main wind speed in the daytime, when the air is being mixed by being warmed by the ground, to under 30% at night, when air - cooled by the ground - loses buoyancy. This varying wind speed with height is called the wind gradient.

A wind gradient associated with wind blowing towards a loudspeaker will "slow" its vertical wavefront differentially. The vertical wavefront will be slowed less near the ground and its sound path will veer upwards.

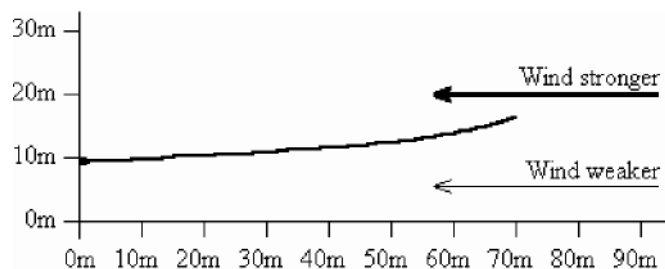

Sound path tilting upwards outdoors due to wind blowing towards loudspeakers.

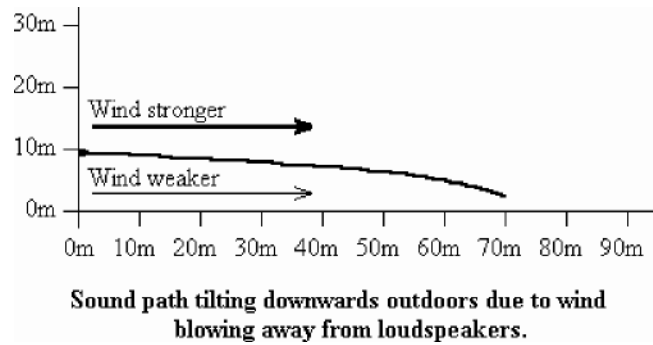

Conversely, a wind gradient associated with wind blowing from behind a loudspeaker system will "speed up" its vertical wavefront differentially. The vertical wavefront will be speeded up less near the ground and its sound path will veer downwards.

Local winds

Air absorbs very little heat from the sun's rays. It is indirectly heated by contact with warm surfaces. It also relies on contact with cooling surfaces to loose heat.

An anabatic wind can be set up by air rising up a slope warmed by the morning sun.

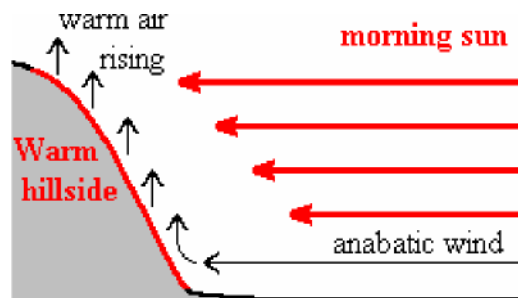

At night, cool air may flow down hill to form a katabatic wind. To maintain coverage, loudspeaker cluster tilts may need to be readjusted between morning orchestral rehearsals for a major outdoor event and the actual show.

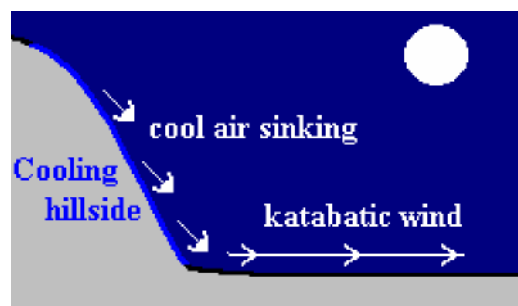

Gusts and squalls

On a fair day when the ground is warm and clouds are forming and being moved by a very light breeze, local winds may vary in direction and strength as illustrated below.

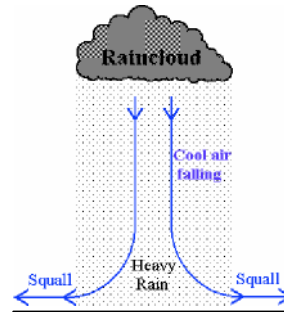
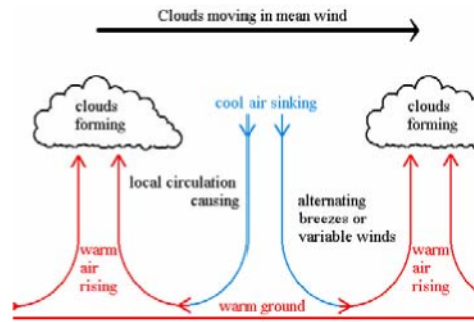

Local winds may be even more erratic in showery weather. Dramatic down-drafts of cold air may occur causing local squalls.

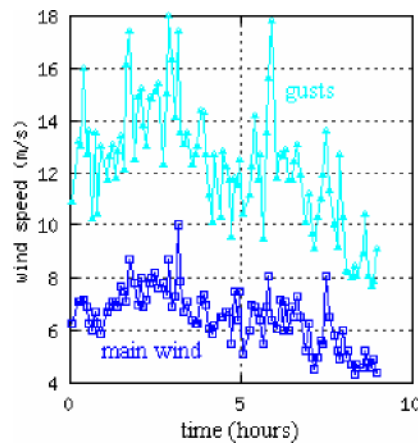

Graph showing main wind speed (dark colour) and gusts (light colour) over several hours

The above main wind and gust plot shows that gusts can be more erratic in nature and several times stronger than the main wind. Their effects will be far more audible than a steady wind.

Anti-phasing eq

It may be advisable to roll off the system's high frequency response during gusts and squalls as a decreasing hf response sounds more natural than the incoherent swishing noise associated with phasing. A single pole (6dB per octave) high cut filter with a variable knee control down to 8KHz works well.

Temperature effects

The speed of sound varies with air temperature. This means that the speed of sound can vary from 331.5m/s to 354.9m/s between 0°C and +40°C.

The commonly accepted formula for the speed of sound through air is:

$$\text{Speed of sound} = \sqrt{\frac{\gamma RT}{M}} = 20.055 \sqrt{273.16 + ^\circ\text{C}} \text{ meter/second}$$

Where γ = specific heat ratio = 1.402
 R = gas constant = 8.314 (joules/mole K)
 T = temperature, K
 M = 0.02898 (kg/mole)

Temperature Gradient

Air is a poor heat conductor and relies on surface contact to heat and cool. On a clear, warm, day the ground will warm low level air and the atmosphere will heat up, by convection, from bottom to top. Warm air cannot rise to the top of the atmosphere because air pressure drops with height and air temperature falls as the pressure falls.

Sound will travel faster near the ground and slower higher up causing its path to be tilted upwards.

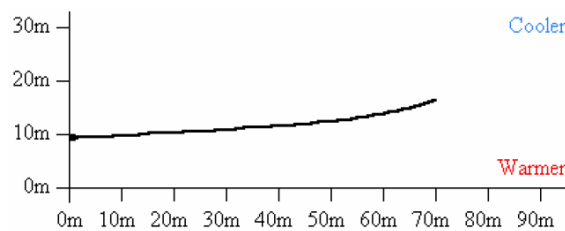

Sound path tilting upwards outdoors due to normal temperature decrease with height.

If the sky clears after sunset, the ground will cool. Air nearest the ground will cool. In the absence of wind, this cool air may stay near the ground on a still night.

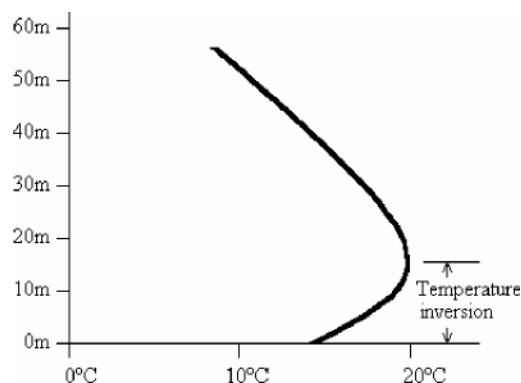

The same “inverse temperature gradient” can form above ice rinks and in many indoor

venues. Sound will now travel slower near the ground and faster higher up causing its path to be tilted downwards.

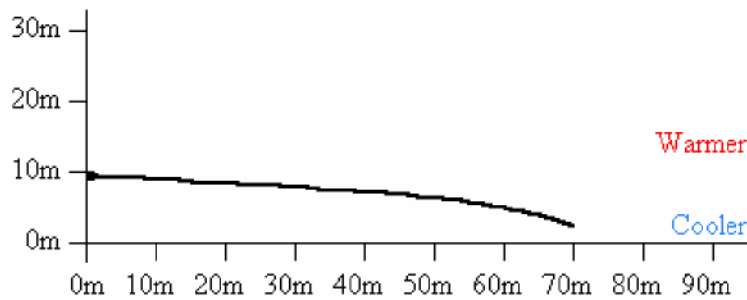

Sound path tilting down indoors due to high level heating or low level cooling (eg ice rink) or outdoors due to cooling ground

Air absorption

Many users believe that line array sound pressure levels drop by only 3dB per doubling of distance and this belief can lead to over-optimistic predictions of line array long-throw characteristics. Air absorption reduces high and mid frequencies proportional to distance depending on relative humidity.

ATMOSPHERIC EFFECTS

Molecular Absorption

Molecular absorption refers to the attenuation of sound intensity as a result of its passage through the medium, in this case air. The mechanisms of molecular absorption are quite complex, however, the overall effect can be considered as the product of three known factors; classical absorption, rotational relaxation and vibrational relaxation. Classical absorption and the rotational relaxation of oxygen molecules are considered together due to their linear relationship with frequency.

Classical absorption

Classical absorption is termed such as it results from the transport processes of classical physics; namely shear viscosity, thermal conductivity, mass diffusion and thermal diffusion.

Rotational absorption

Rotational absorption, however, results from the relaxation of the rotational energies within the molecule caused by pressure changes induced by the sound wave.

Vibrational relaxation

Vibrational relaxation within the molecules of a gas results from the vibrational storage of incident energy within the molecule rather than translational storage through the physical displacement of that molecule. Given that this energy converts to translational energy almost immediately, the finite time period taken to do so introduces a lag in the sound wave between changes in pressure and density. This lag, therefore, is the cause of a slight reduction in the intensity of the acoustic wave.

As is the nature of the two molecules, the main effects of vibrational relaxation in oxygen and nitrogen occur at different frequencies. The effects of nitrogen on the lower portion of the audible spectrum is only a recent addition to predictive formulae, thus, many earlier methods such as those by Knesser and Evans & Bazley grossly under-predict absorption below 1 - 2kHz.

The vibrational relaxation frequencies of nitrogen and oxygen molecules are, to small extent, a function of atmospheric pressure and temperature, with the main determinant being the molar concentration of water vapour within the air. Though the amount of absorption is virtually unaffected by the water vapour content, it does significantly affect the relaxation times of the two molecules, thus shifting the vibrational frequencies within the audible spectrum. The actual molar concentration at any particular time is governed by both temperature and the ratio of partial pressure to the vapour pressure at saturation of any given air sample.

Note: The resulting coefficient represents a reduction in sound intensity per metre distance. The major point to be considered about molecular absorption is that it is linear with distance, not logarithmic. Thus, unlike geometric spreading, its effects tend to become much more important with increasing distance.

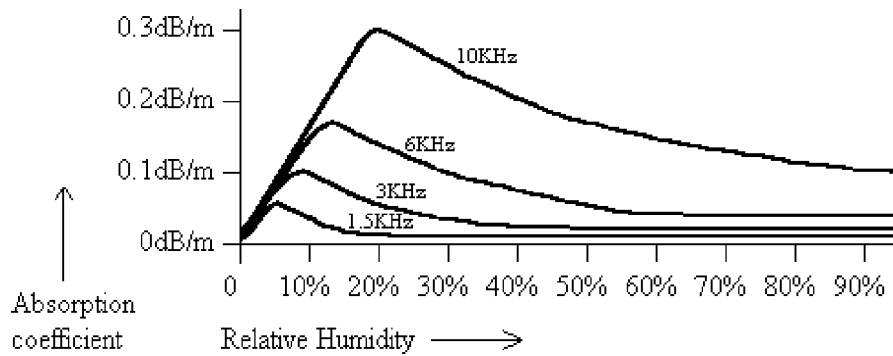

Under the above conditions air absorption at 10KHz can reach 0.3dB/m at 20% RH. This means 30dB excess attenuation (over and above the 3dB per doubling of distance) at 100m from the column. The incredible high frequency efficiency and headroom of the W8L Longbow can prove beneficial here.

Air absorption also varies with temperature (see table below) and is notoriously difficult to predict with accuracy. The best policy is to get your crew to check all audience areas during the performance and apply a sensible amount of correction. Luckily, a large audience tends to raise the local humidity so hf absorption often reduces once the audience is in place. Line array systems should be corrected with caution and distant audience areas rechecked at regular intervals during large events.

5.9 Delay systems

One of the notable advantages of line array columns over multi-cabinet arrays is the greatly improved high frequency throw. Line arrays offer greater high frequency output capability due to typically greater numbers of drivers per cabinet and also improved summation between high frequency elements in each cabinet. However, all sound sources are subject to the same losses due to propagation through the atmosphere and there will come a point where there is not sufficient headroom to compensate for the high frequency absorption and delay systems become necessary.

Air absorption (air excess attenuation) is a function of temperature, humidity, static pressure and frequency. The relation between these quantities is quite complex but losses always increase as frequency and distance from the source increases.

The table below shows the distance at which air absorption is causing a loss of 12dB at 8kHz for a range of temperatures and humidity. This frequency is the lower limit for producing an acceptably full range sound and 12dB is the maximum boost that should be applied to maintain acceptable system headroom.

You can see that at 20°C and 25% humidity there is a 12dB loss at 8kHz at only 62m from the source and delay systems would be required to cover further. You can also see that at 25°C and 40% humidity the distance is increased to 113m, which would cover the majority of situations.

15 deg C Humidity %	Distance for 12 dB loss at 8kHz (m)	20 deg C Humidity %	Distance for 12 dB loss at 8kHz (m)	25 deg C Humidity %	Distance for 12 dB loss at 8kHz (m)	30 deg C Humidity %	Distance for 12 dB loss at 8kHz (m)	35 deg C Humidity %	Distance for 12 dB loss at 8kHz (m)
0	1055	0	1036	0	1017	0	998	0	980
5	256	5	159	5	99	5	65	5	47
10	107	10	70	10	52	10	46	10	48
15	70	15	55	15	52	15	56	15	66
20	60	20	56	20	61	20	72	20	87
25	59	25	62	25	73	25	89	25	107
30	63	30	71	30	86	30	105	30	125
35	69	35	82	35	100	35	121	35	142
40	76	40	92	40	113	40	136	40	156
45	84	45	103	45	126	45	149	45	169
50	92	50	114	50	138	50	162	50	179
55	101	55	124	55	150	55	173	55	188
60	109	60	135	60	161	60	183	60	196
70	126	70	154	70	181	70	200	70	207
80	143	80	172	80	198	80	213	80	213
90	158	90	189	90	213	90	223	90	216
100	173	100	204	100	225	100	230	100	217

High frequency compensation

The high frequency elements of larger W8L Series columns are split into three sections which cover short, medium and long throw.

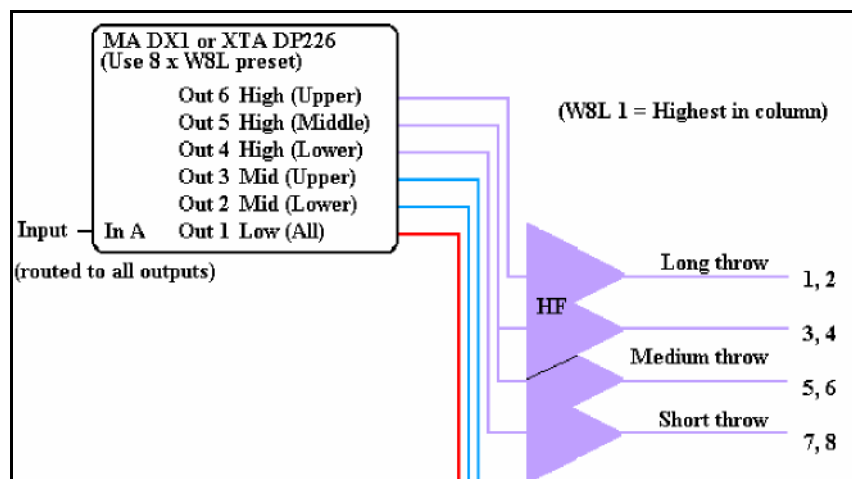

This allows high frequency (air absorption) and compensation to be tailored to suit each section. The standard controller settings already incorporate a degree of shelving and peaking boost as throw increases.

When equalising the W8L Series systems do not add more than 8dB of boost to compensate for air absorption if the system is to be driven hard. Delay systems should be considered if very dry (or windy) conditions are expected.

The medium throw section of larger W8L Series columns can be set for a wider HF bandwidth as they require less air absorption equalization. Typically peaking frequencies are 8kHz for very long throw W8L sections and 12kHz for the medium throw sections.

In more favourable conditions these peaking frequencies can be increased to 10kHz for the long throw section and 14kHz for the medium throw section. Parametric filters with a Q of 2 are favoured for very high frequency peaking as their more selective boost improves system headroom.

Short throw sections of a W8L don't normally need high frequency compensation.

Our standard W8L and W8LC controller presets cater for a range of line lengths, curvatures and humidity conditions.

Mid frequency compensation

The mid frequency elements of larger W8L Series columns are split into two drives which cover the upper, straighter far-field sections, and the lower, more splayed near-field sections.

5.10 W8L/Longbow and W8LD Quick Start Guide

Important note:

This information assumes the reader is an experienced sound system technician who is familiar with high quality, low noise system design and works to the internationally recognized 93/68/EEC Low Voltage Directive for mains safety. All rack systems should be fully PAT (Portable Appliance) tested for electrical safety before use.

What would a typical W8L/Longbow rack look like?

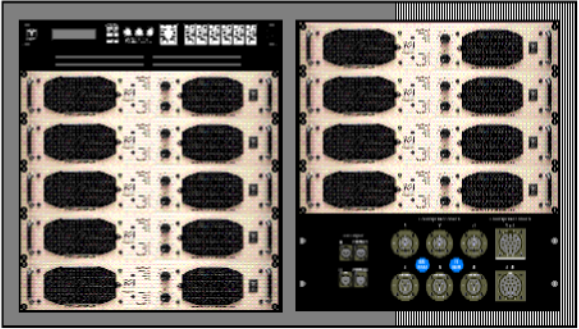

DX1 controller
1U vent space

9 x MA4.2S for 12 x W8L

63A mains inlet distributed via 2 x 32A breakers (on rear)

Input/output panel

**Typical amplifier rack driving 12 x 3-way line array cabinets via 6 loudspeaker outlets.
Each outlet drives 2 x 3-way cabinets. Each amplifier channel drives 2 sections (ie 2 x lf, 2 x mf or 2 x hf)**

(Note: Mains info shown for 230Vac single phase supply)

Can I parallel drive W8L/Longbow cabinets?

Yes. In normal systems W8L/Longbow cabinets are paralleled in pairs at the loudspeaker column using short link cables. All W8L/Longbow section are 8 ohms. Each cable sees a two-speaker load so cables must be rated for a 4 ohm load. See cable recommendations later.

In theory it is possible to drive more than two cabinets in parallel using MA4.2S power amplifiers but sonic performance could suffer for the following reasons:

- 1) The rack mains current demand may cause mains voltages to drop or exceed the breaker ratings. The former would reduce sound quality, the latter would mute whole system sections
- 2) Band zoning (the progressive shelving control applied to the upper mid & high frequency sections of line array columns to partially compensate for air absorption) will be in coarser steps. Coverage won't be as smooth.

How many amplifiers do I need to drive a typical W8L/Longbow system?

The simple rule of thumb is 3 power amplifiers for 4 W8L/Longbow cabinets...

3 x 2ch MA4.2S power amplifiers drive 4 x W8L/Longbows
6 x 2ch MA4.2S power amplifiers drive 8 x W8L/Longbows
9 x 2ch MA4.2S power amplifiers drive 12 x W8L/Longbows
12 x 2ch MA4.2S power amplifiers drive 16 x W8L/Longbows

Can I split the system into smaller racks with, say, 3 amps per rack?

Yes. But remember that our MA4.2S amplifier weighs only 10kg so a double width rack housing 9 MA4.2S amplifiers for a standard 12-box system may be no heavier than a single rack system using conventional power amplifiers. A double width rack will cater for band zoning (the progressive shelving control applied to the upper mid & high frequency sections of line array columns to partially compensate for air absorption) without the need for dedicated master and slave racks linked with complicated multi-core links. See example of 3-amplifier master-slave rack system for a 12 x W8L/Longbow system later.

Why do I need high power amplifiers for the mid & high frequency sections?

There are several reasons for this:

- 1) Although vocal and percussive signals demand fairly low continuous power, their peak power can be much higher. Many touring systems have less than adequate peak power at mid and high frequencies and simply clip vocal fricatives and percussion transients producing poor mid and high frequency definition.
- 2) Our mid and high frequency sections are designed to reproduce these peak power transients faithfully without stress. We use carefully matched RC coupling networks to compensate for high frequency driver voice coil inductance. These coupling networks improve transient performance and present an easy load to the power amplifier whilst maintaining a high frequency efficiency of 1 13dB/W/m.
- 3) Line Arrays are designed for long throw applications. Air absorption can cause significant high frequency attenuation at low humidity. Line array columns are usually band zoned (ie progressive shelving control is applied to the upper mid & high frequency sections of line array columns to partially compensate for air absorption). This band zoning relies on the exceptional mid and high frequency performance provided by adequately powered high-efficient mid and high frequency sections.

Please note that our standard controller limiters are set with finite attack times. This allows all them to pass transient signals to the full output capability of the MA4.2S

without compression but to pull back to a suitable continuous power for sustained signals such as rail-to-rail feedback.

Although the long-term limiter thresholds are lower for the mid and high frequency sections (LF +7dBu, MF +4dBu, HF +1dBu), all W8L/Longbow sections are designed to accept full MA4.2S power on transients...

W8L/Longbow section	Max continuous demand	Max transient demand
Low frequency	1204W	2300W
Mid frequency	602W	2300W
High frequency	301W	2300W

How much mains power will I need?

Many touring systems are supplied with inadequate mains power causing the system to sound like the PA equivalent of a portable radio with a flat battery!

Here are the current consumption figures for the recommended MA4.2S power amplifier. When used with our standard crossover and limiter settings.

230Vac operation to DX1 limiter threshold, 2 W8L/Longbow sections per ch: 6A
115Vac operation to DX1 limiter threshold, 2 W8L/Longbow sections per ch: 12A

A rack with 9 MA4.2S amplifiers (each driving 2 W8L/Longbow sections per channel for a total of 12 W8L/Longbow cabinets) will require a minimum of 54amps at 230Vac and 108amps at 115Vac under typical live sound conditions. We would recommend 63A at 230Vac and 120A at 115Vac.

Here are the **MINIMUM** figures for typical racks:

Number of W8L/Longbow cabinets	Number of MA4.2S amplifiers	Minimum current	Minimum current
		for 230 Vac single phase mains	for 115Vac single phase mains
4	3	18A	36A
8	6	36A	78A
12	9	54A*	108A*
16	12	78A*	156A*

* Large racks are often supplied with 3-phase mains - e.g. a 9-amplifier rack may be wired with three MA4.2S amplifiers per phase and a 12-amplifier rack may be wired with four MA4.2S amplifiers per phase. The above minimum current figures may be divided by 3 when a 3-phase mains supply is used.

How should I distribute mains power within the rack?

Normal distribution practice applies – e.g. a 230Vac inlet 63A inlet would be split into 2 x 32A spurs which would supply the appropriate outlet strips via 32A breakers.

Remember that, although the transient power demand will be the same for each W8L/Longbow section (see table earlier), medium to long-term power demand will be

greater at lower frequencies. It is wise to spread the long-term current by supplying a mixture of low, mid and high frequency amplifiers from each breaker.

Single Phase Breaker (e.g. 32A Europe 63A USA)	4 x W8L/Longbow 3 x MA4.2S	8 x W8L/Longbow 6 x MA4.2S	12 x W8L/Longbow 9 x MA4.2S	16 x W8L/Longbow 12 x MA4.2S
A	1 LF, 1 MF, 1 HF, 1 DX1	1 LF, 1 MF, 1 HF	2 LF, 1 MF, 1 HF	2 LF, 1 MF, 1 HF
B		1 LF, 1 MF, 1 HF, 1 DX1	1 LF, 2 MF, 2 HF, 1 DX1	1 LF, 2 MF, 1 HF
C				1 LF, 1 MF, 2 HF, 1 DX1

Three Phase Breaker (e.g. 32A Europe 63A USA)	12 x Longbow 9 x MA4.2S	16 x Longbow 12 x MA4.2S
Phase A	1 LF, 1 MF, 1 HF	2 LF, 1 MF, 1 HF
Phase B	1 LF, 1 MF, 1 HF	1 LF, 2 MF, 1 HF
Phase C	1 LF, 1 MF, 1 HF, DX1	1 LF, 1 MF, 2 HF, 1 DX1

We recommend supplying each MA4.2S amplifier via a 16A cable and 16A single phase connector for 230Vac mains and via a 32A cable and 32A single phase connector and breaker for 11 5Vac mains. Please refer to the MA4.2S manual for further information.

Reminder:

This information assumes the reader is an experienced sound system technician who is familiar with high quality, low noise system design and works to the internationally recognized 93/68/EEC Low Voltage Directive for mains safety. All rack systems should be fully PAT (Portable Appliance) tested for electrical safety before use.

Why do I need a 6-output DX1 controller for a 3-way cabinet?

When line arrays are used for long throw applications air absorption can cause significant high frequency attenuation at low humidity. Progressive mid and high frequency shelving is applied to the upper zones of W8L/Longbow columns to partially compensate for this air absorption. This progressive shelving is called band-zoning because one extra mid frequency band and two extra high frequency bands drive the upper zones of the line array.

Our standard W8L/Longbow presets configure the DX1 to produce these extra bands. This requires 6 outputs; 1 x LF, 2 x MF, 3 x HF. See [section 5.5.23](#).

How do I patch my racks to take advantage of standard W8L/ longbow controller presets?

Standard W8L or Longbow presets configure Martin Audio DX1 or XTA DP226 outputs for the following controller-to-amplifier patches:

DX1 o/p	4 x W8L/ Longbow	6 x W8L/ Longbow	8 x W8L/ Longbow	10 x W8L/ Longbow	12 x W8L/ Longbow	14 x W8L/ Longbow	16 x W8L/ Longbow
6 Upper HF			Upper 2 HF	Upper 4 HF	Upper 6 HF	Upper 8 HF	Upper 10 HF
5 Middle HF	Upper 2 HF	Upper 4 HF	Middle 4 HF	Middle 4 HF	Middle 4 HF	Middle 4 HF	Middle 4 HF
4 Lower HF	Lower 2 HF	Lower 2 HF	Lower 2 HF	Lower 2 HF	Lower 2 HF	Lower 2 HF	Lower 2 HF
3 Upper MF		Upper 2 MF	Upper 4 MF	Upper 6 MF	Upper 8 MF	Upper 10 MF	Upper 12 MF
2 Lower MF	All MF	Lower 4 MF	Lower 4 MF	Lower 4 MF	Lower 4 MF	Lower 4 MF	Lower 4 MF
1 All LF	All LF	All LF	All LF	All LF	All LF	All LF	All LF

DX1 controllers have fully balanced inputs and outputs and MA series amplifiers operate with pin 2 hot. Racks will therefore be pin 2 hot – assuming that I/O panel-to-DX1 input and DX1 output-to-MA series amplifier input cables are wired 1-to-1 (X), 2-to-2 (L), 3-to-3 (R).

Standard balanced & screened XLR cables (typical spec = 70 ohms/1000m, 150pF/m core-core, 300pF/m core-core+screen) should be used between the panel and the DX1 input and between DX1 outputs and MA series amplifier inputs.

Good EMC practice requires that XLR cable screens should be connected at both ends.

W8L/Longbow loudspeaker pin-out and cabling information appears later

Please note that the D-Sub connector on the rear of the DX1 is for loading Martin Audio control presets only. It does not facilitate PC equalizer control “on the fly”.

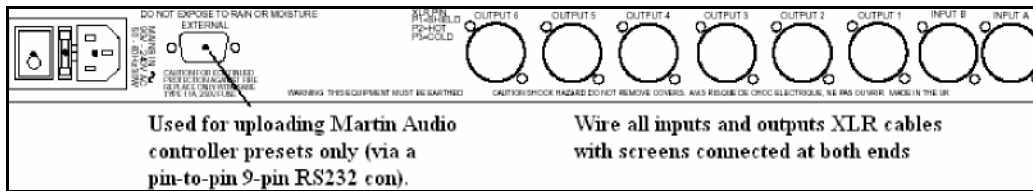

Controller-Amplifier Patching Examples

(For W8L/Longbow pin-outs and cabling see later)

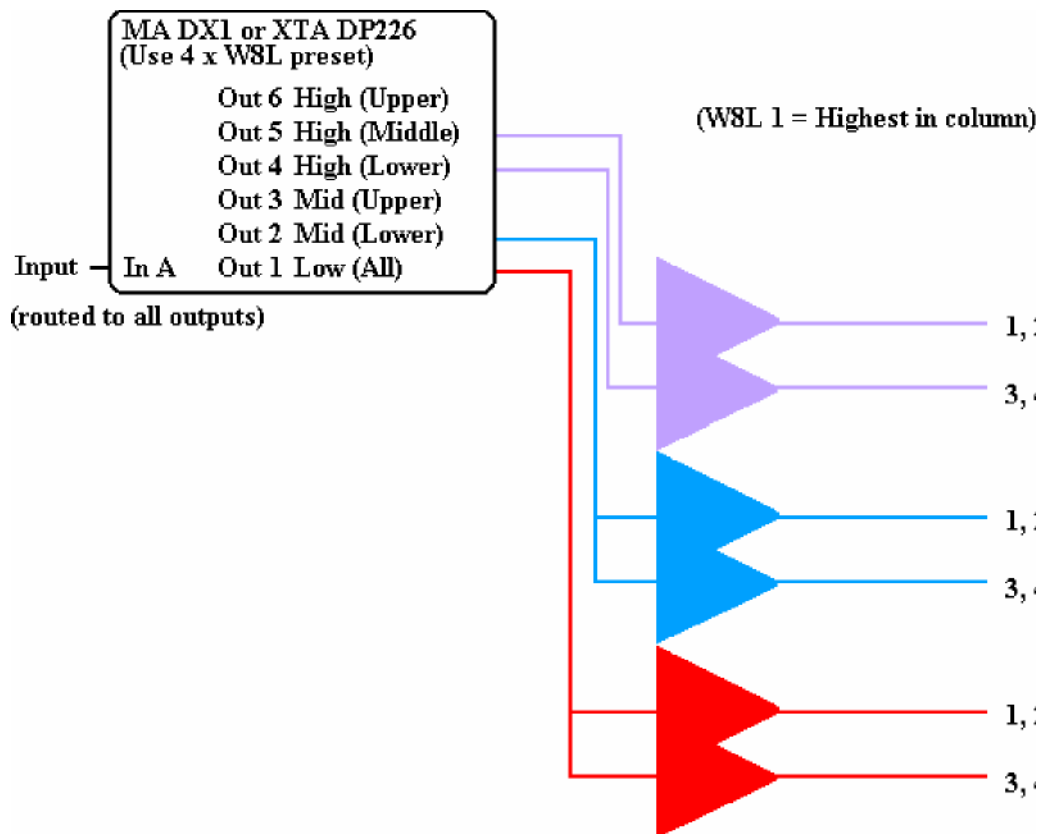

**System patch for 4 x W8L/Longbow array using
1 Martin Audio DX1 and 3 Martin Audio MA4.2S power amplifiers**

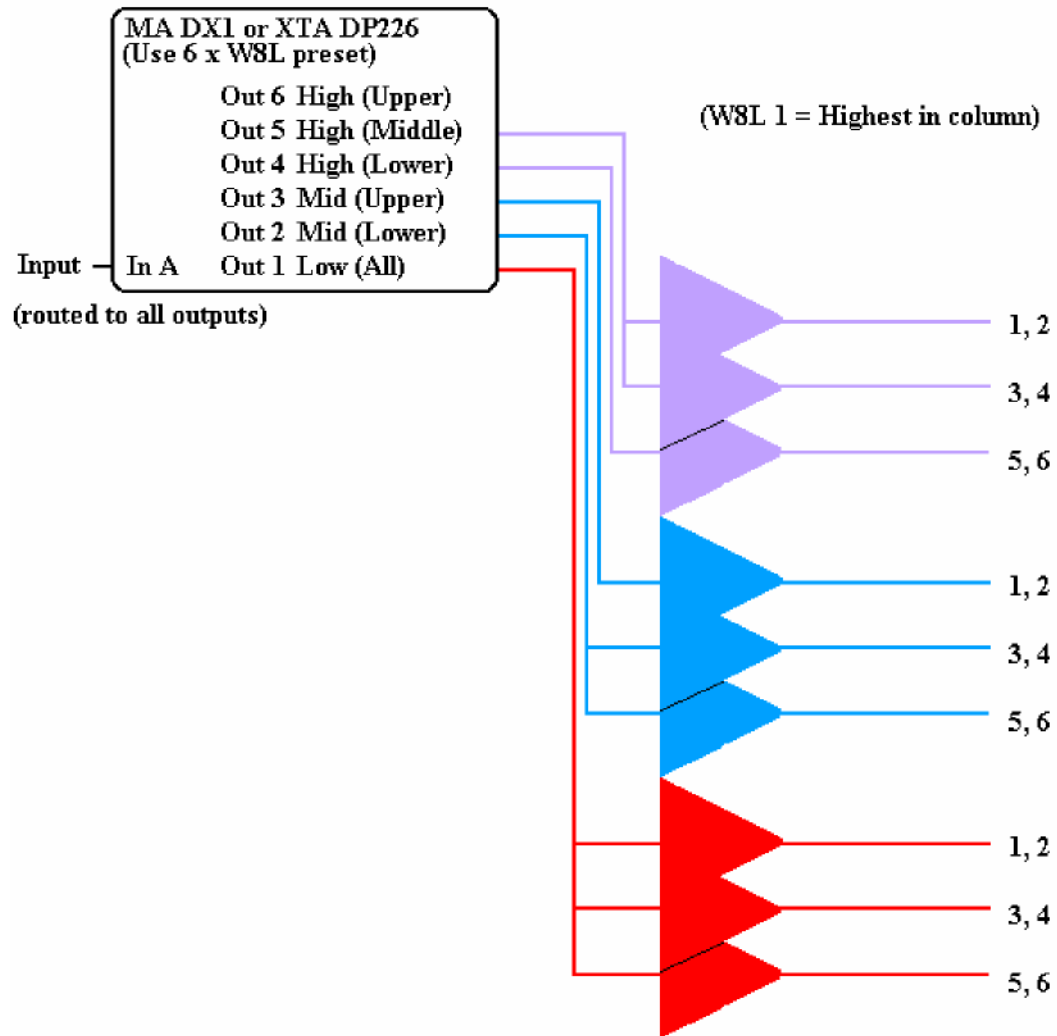

**System patch for 6 x W8L/Longbow array using
1 Martin Audio DX1 and 5 Martin Audio MA4.2S power amplifiers
(leaving 1 spare channel)**

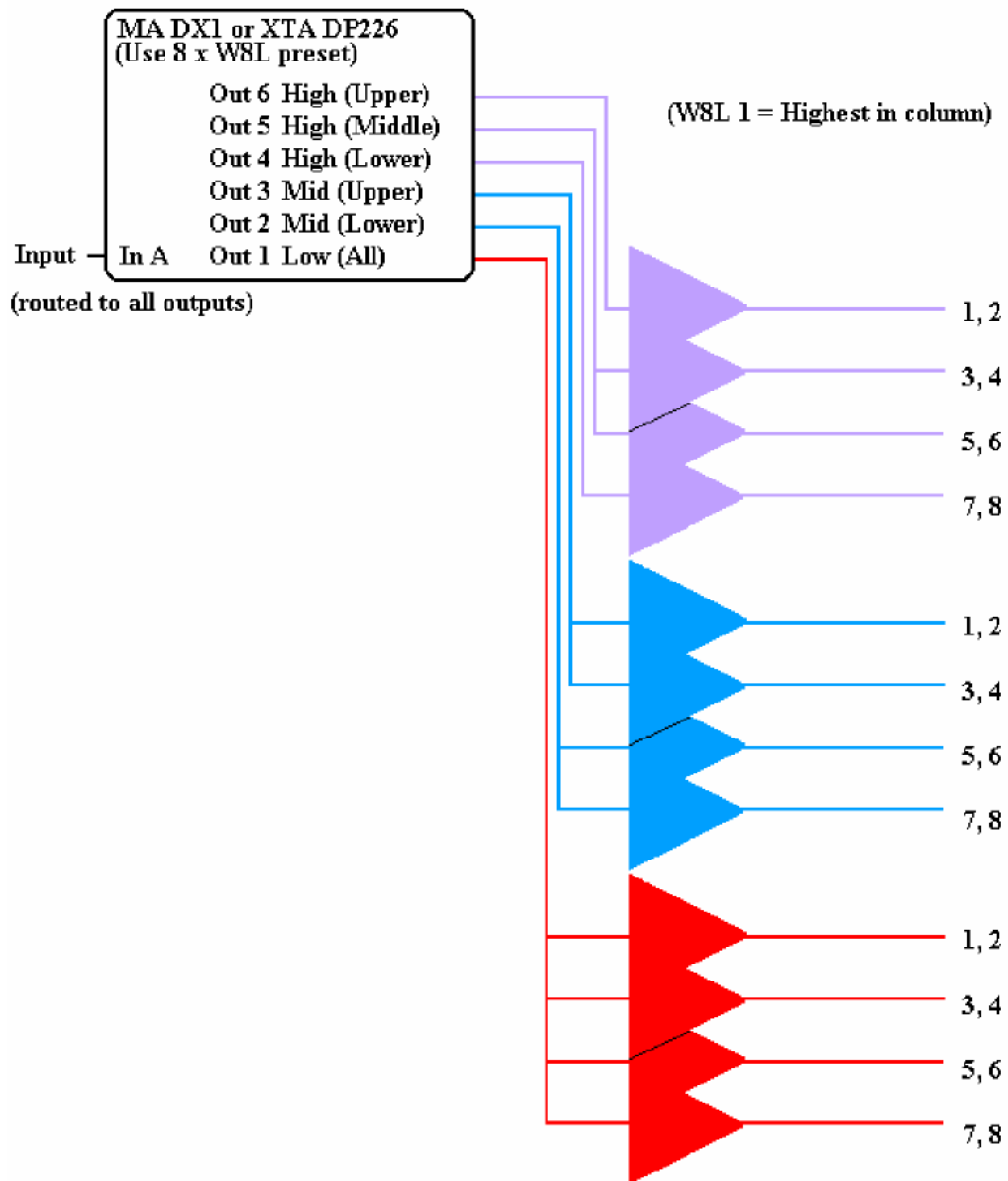

**System patch for 8 x W8L/Longbow array using
1 Martin Audio DX1 and 6 Martin Audio MA4.2S power amplifiers**

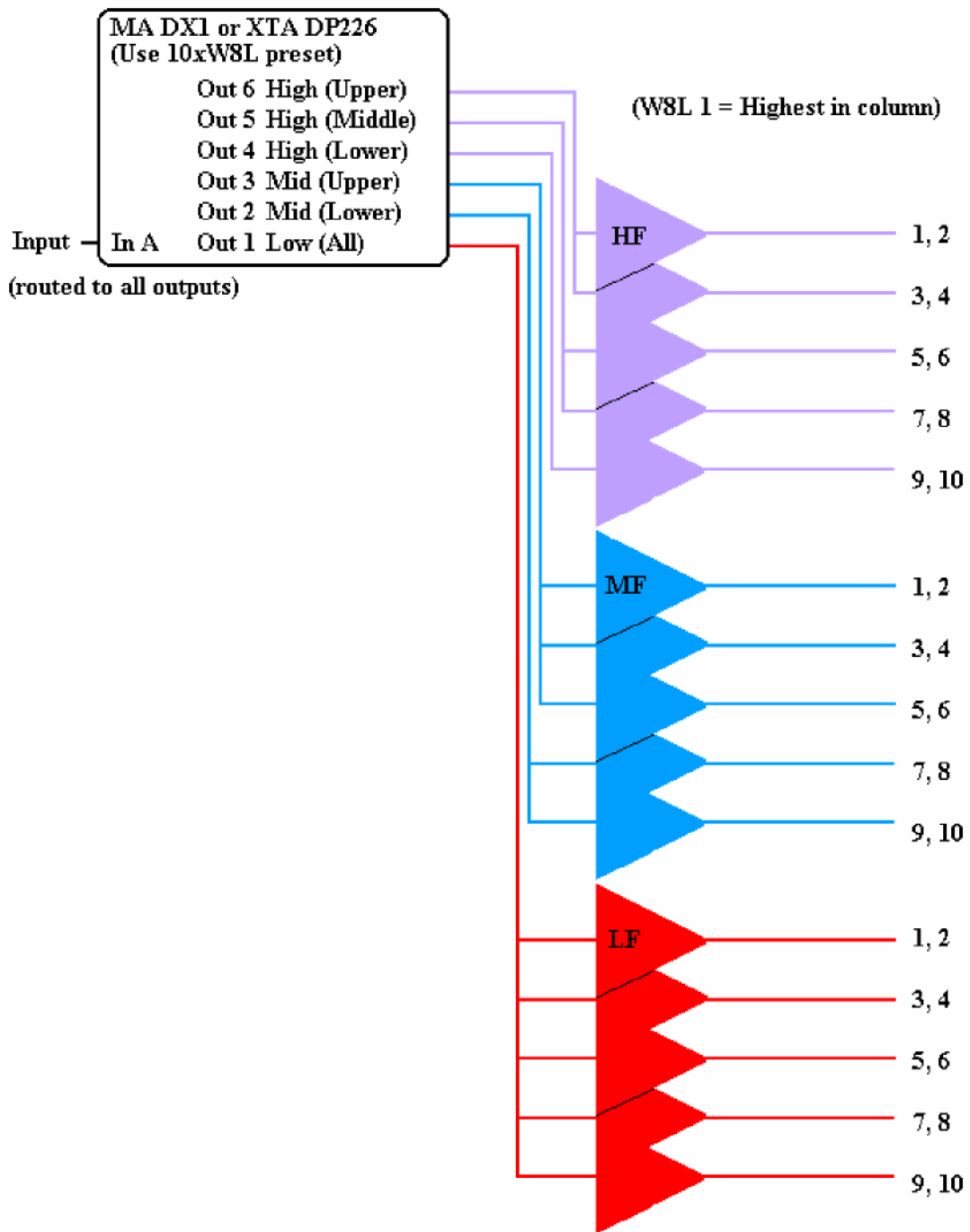

**System patch for 10 x W8L/Longbow array using
1 Martin Audio DX1 and 8 Martin Audio MA4.2S power amplifiers**

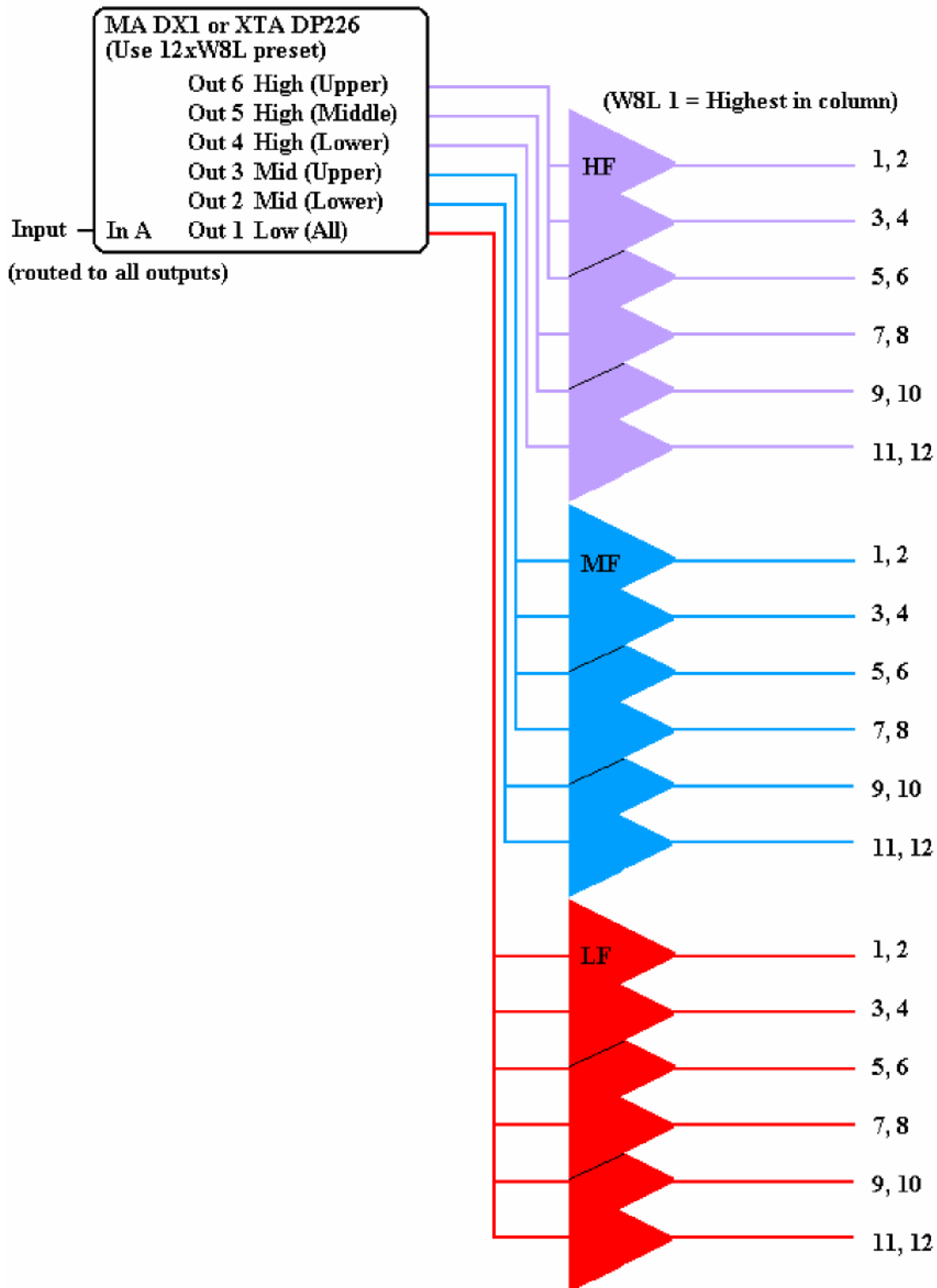

**System patch for 12 x W8L/W8L Longbow array using
1 Martin Audio DX1 and 9 Martin Audio MA4.2S power amplifiers**

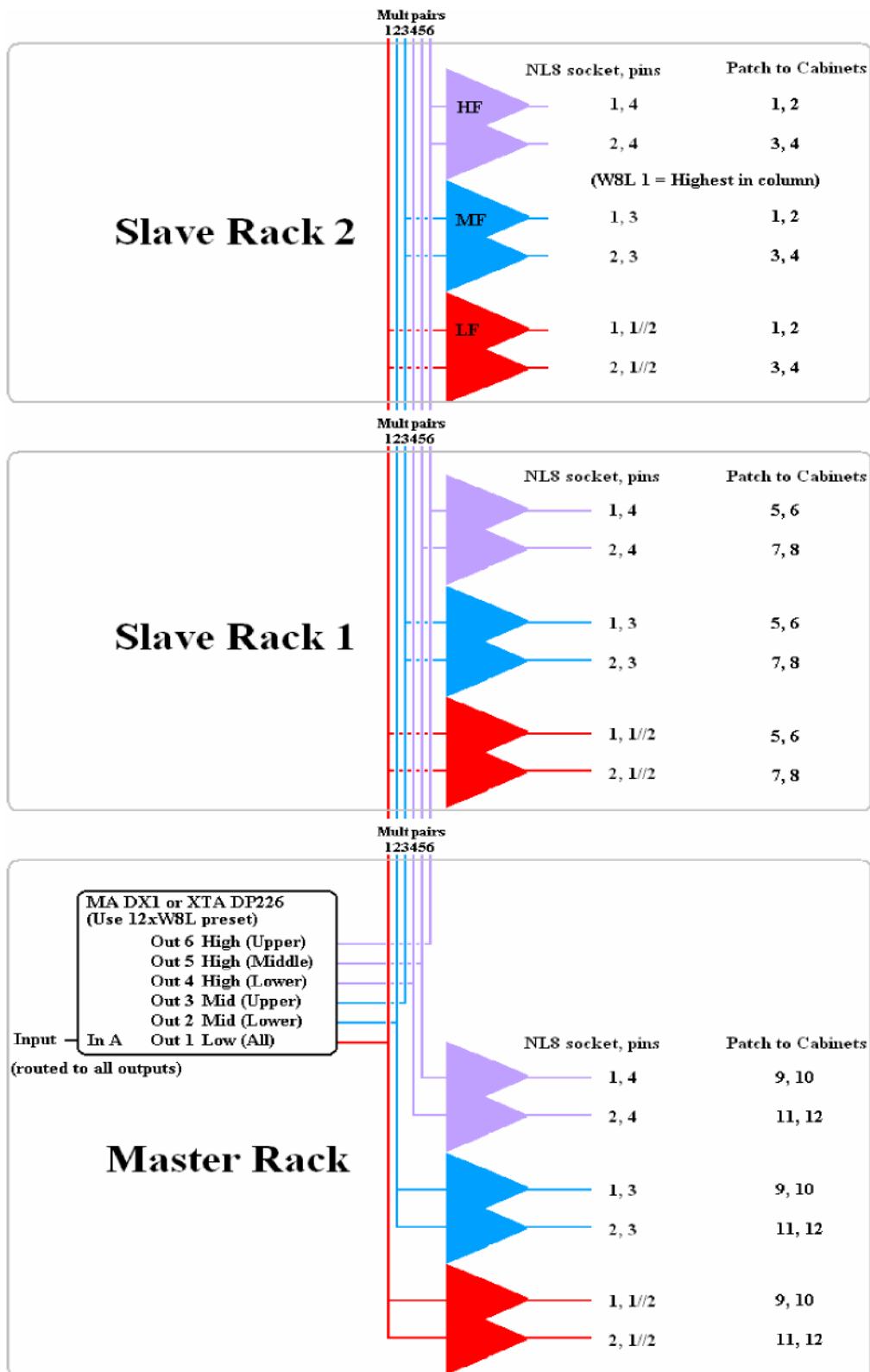

System patch for 12 box W8L/W8L Longbow array using 1 Martin Audio DX1 and 9 Martin Audio MA4.2S power amplifiers arranged in 3-rack Master-Slave configuration

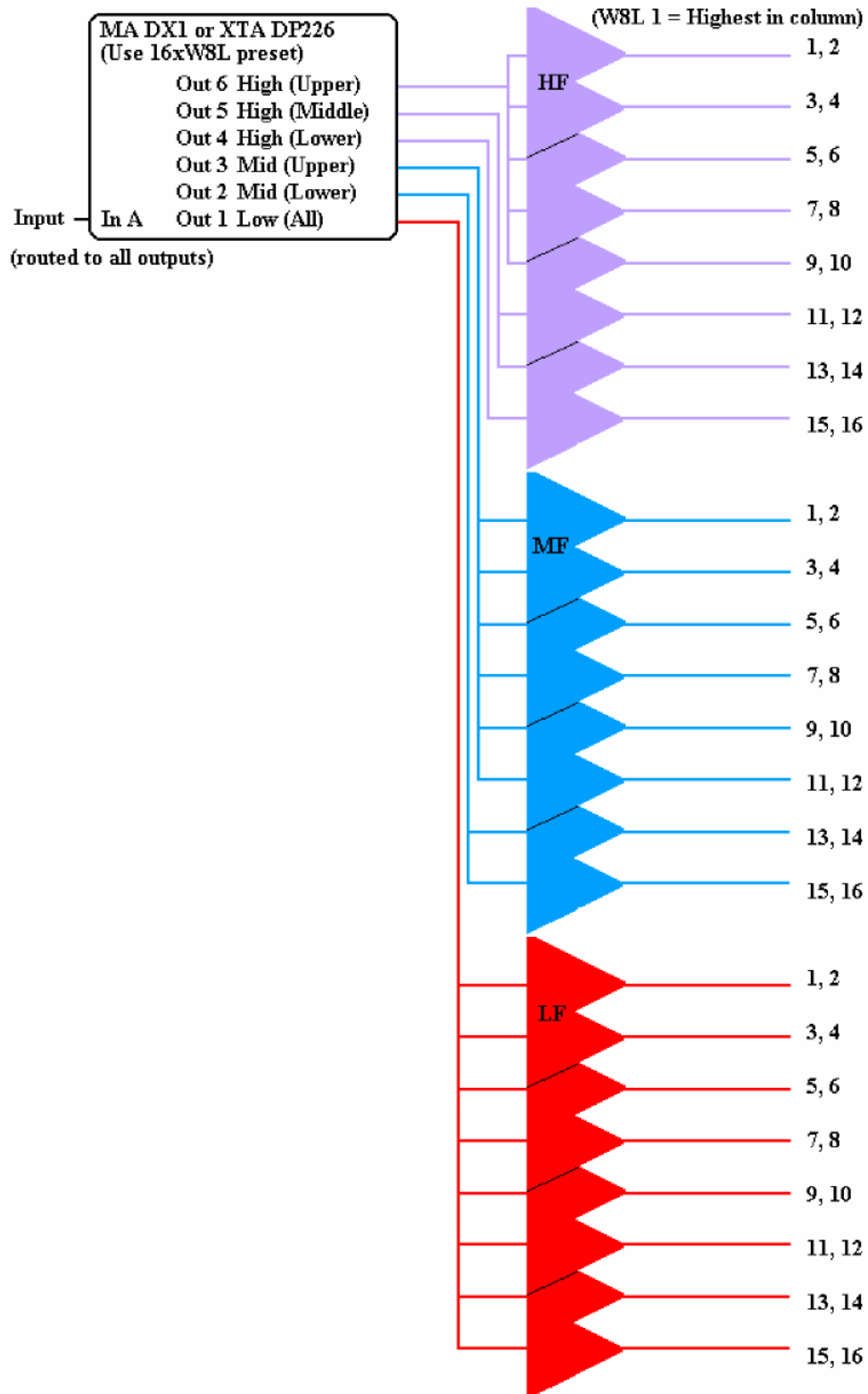

**System patch for 16 x W8L/W8L Longbow array using
1 Martin Audio DX1 and 12 Martin Audio MA4.2S power amplifiers**

W8L/Longbow + W8LD combined system example using 6-way controllers with standard W8L or Longbow presets

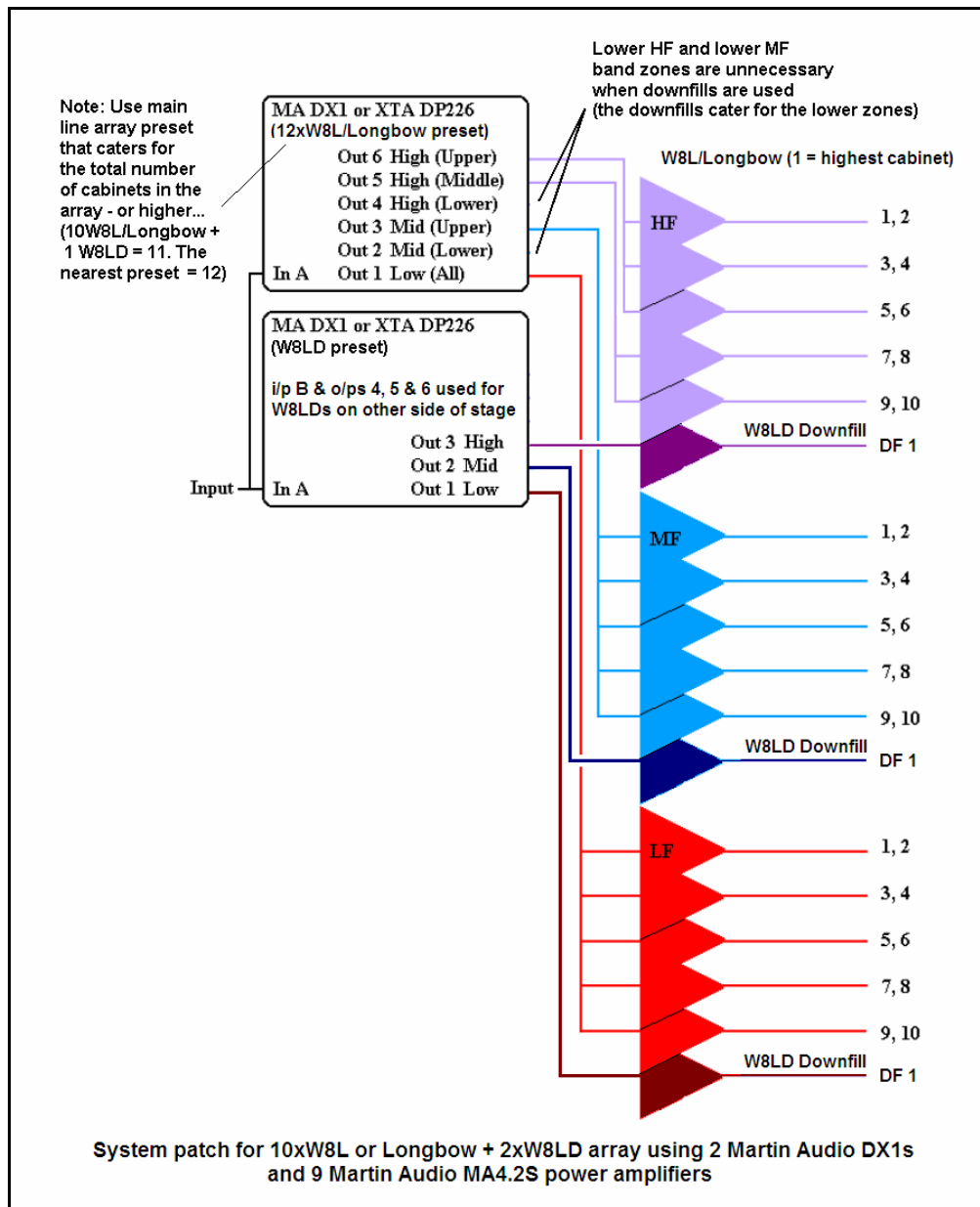

Important notes for all W8L/Longbow + W8LD systems:

- 🚩 Fly the UPPER W8LD from the 6° hole in the W8L or Longbow.
- 🚩 Fly the LOWER W8LD from the 20° hole in the W8LD above.
- 🚩 Make sure the switches on the back of the W8LDs are set to the correct positions...
 - In the UPPER/SINGLE position for the upper W8LD
 - In the LOWER position for the lower W8LD
- 🚩 The lower W8L/Longbow MF & HF band zones are not used as the W8LD takes over their nearfield role.

Full W8LS/WS218X + W8LD + W8L Longbow system examples using 8-way DX2 controller combination presets

8-way controllers can provide the patch configurations required to provide a full system comprising subwoofers, down-fills and main arrays.

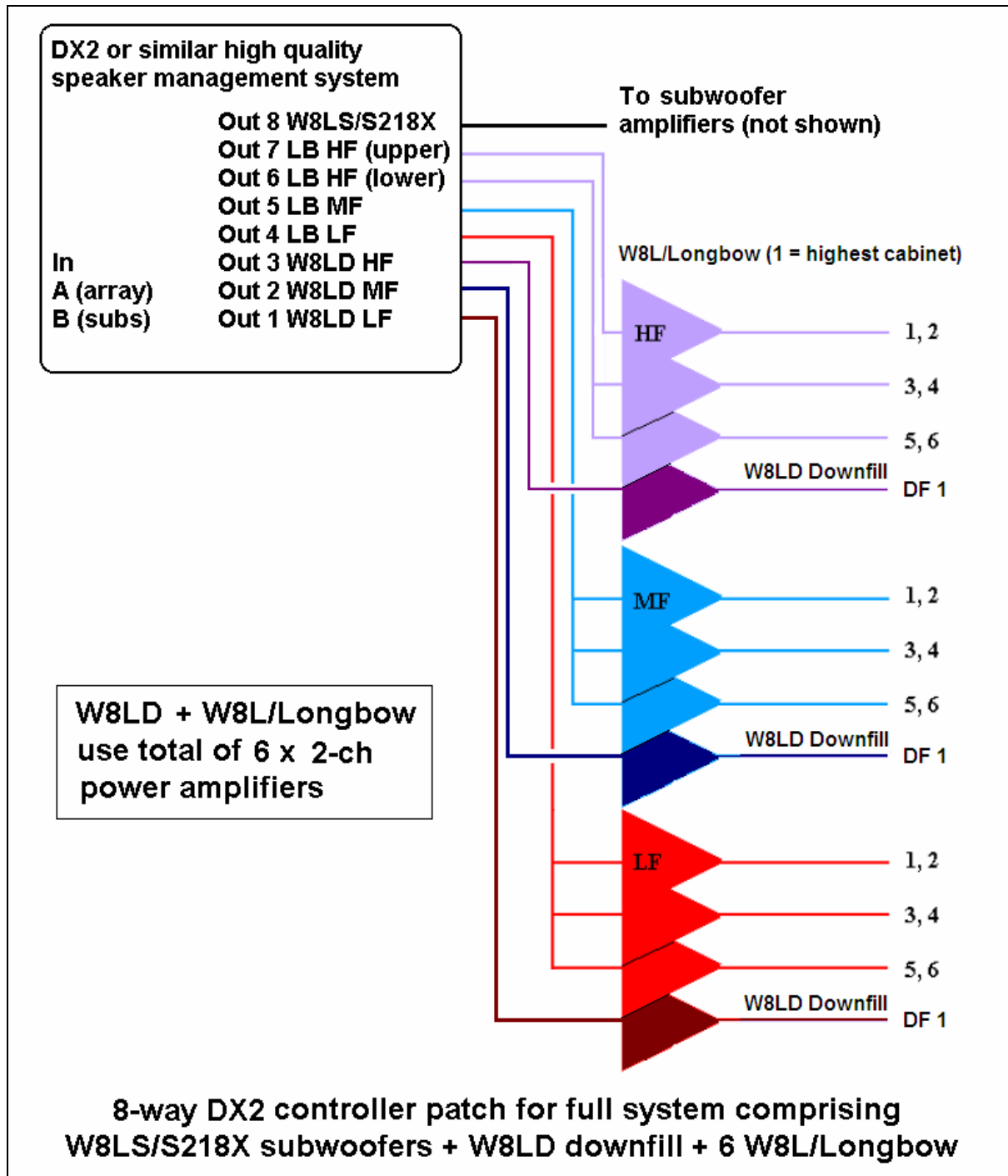

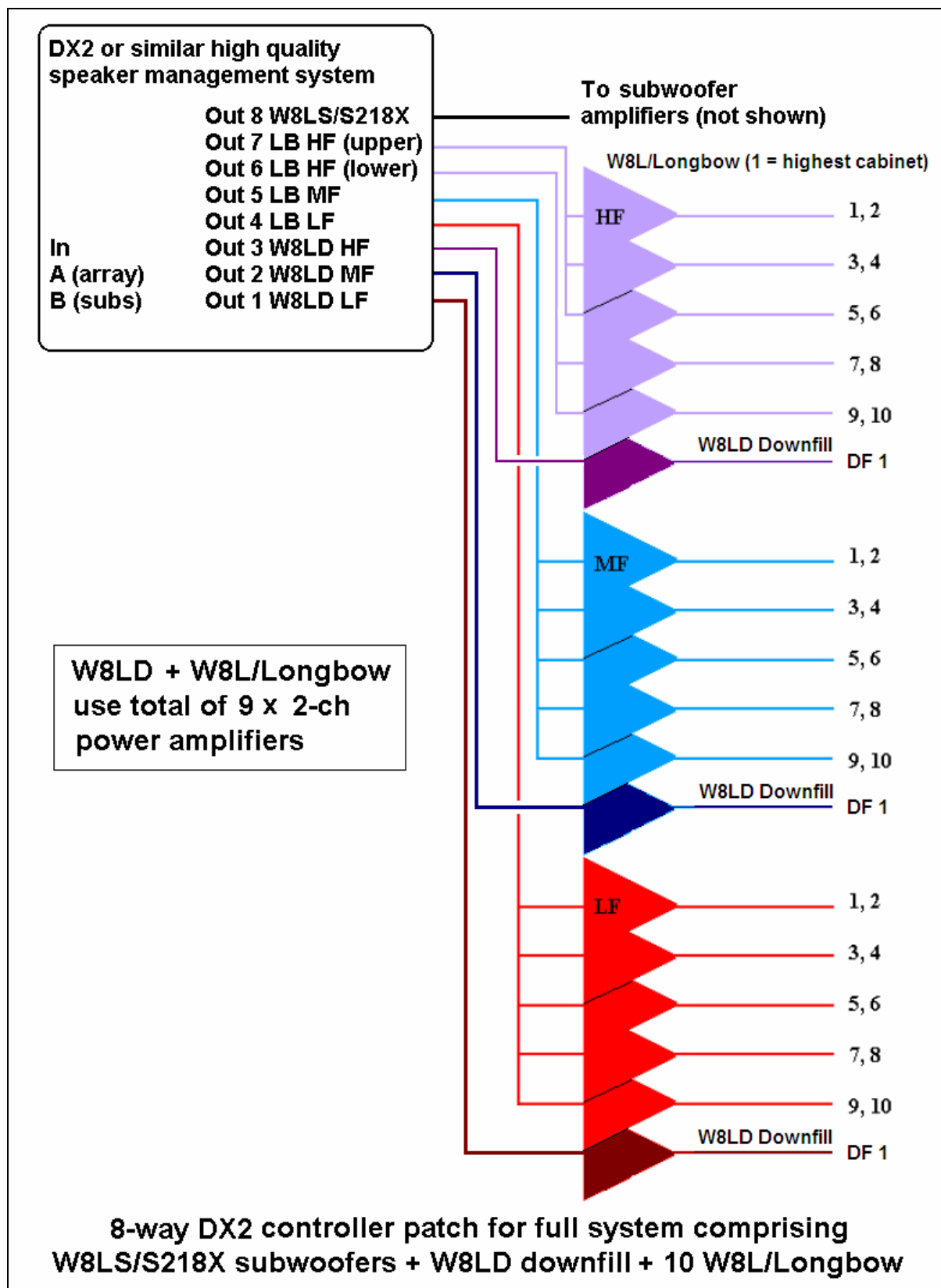

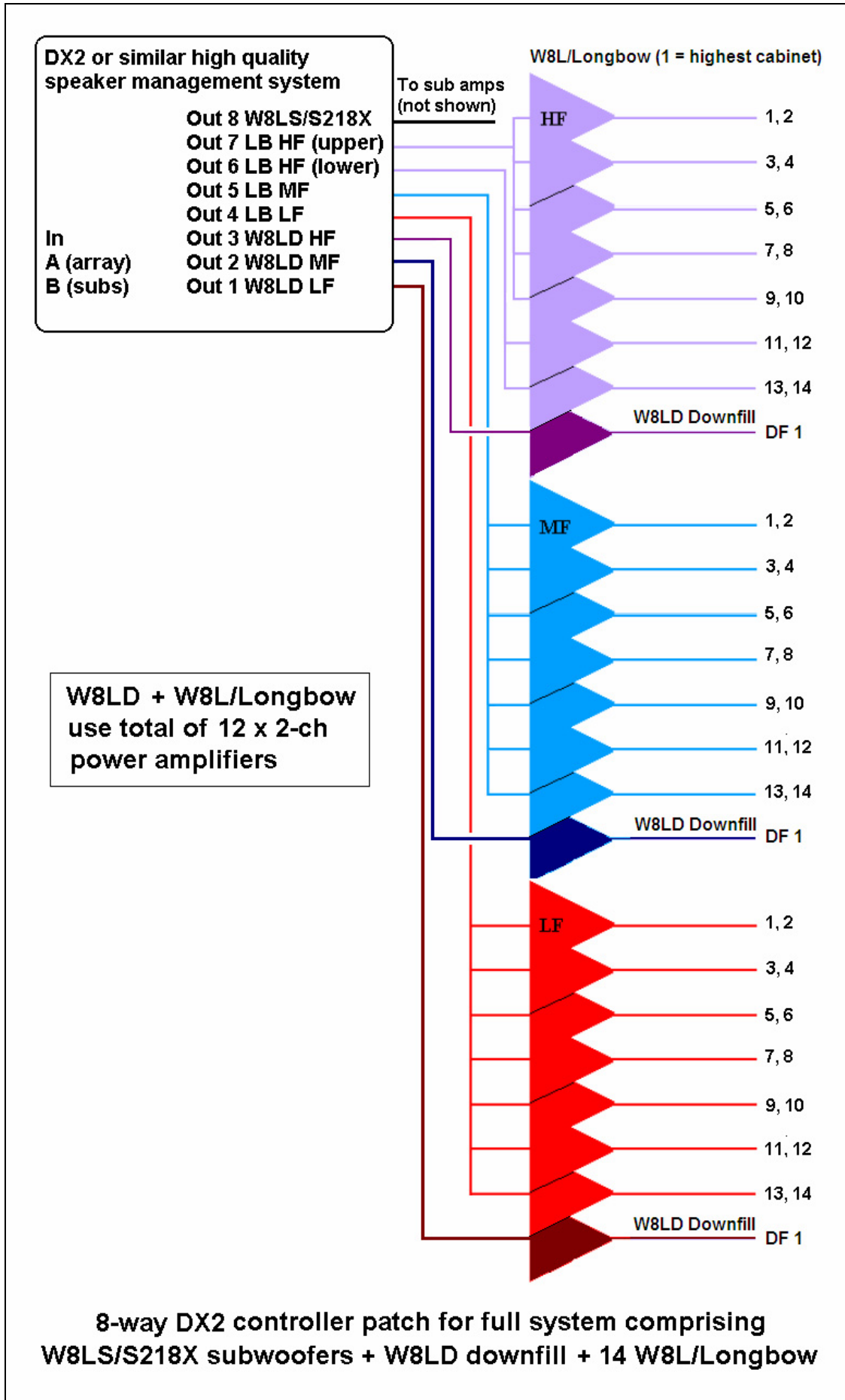

W8L/Longbow and W8LD pin-outs and cabling

Important Note:

MA4.2S power amplifier output NL4 connectors carry both channels (e.g. pins +1/-1 = Ch1, +2/-2 = Ch2).

Always use NL2 connectors for power amplifier outputs to avoid mispatching.

W8L/Longbow

Connector	Connector	Function
NL8	PA-Con	W8L/Longbow
+1	A	Low +
-1	B	Low -
+2	C	Low +
-2	D	Low -
+3	E	Mid +
-3	F	Mid -
+4	G	High +
-4	H	High -

Neutrik Cable and panel connector part numbers

Please note the following part numbers when ordering loudspeaker connectors to make up NL8 cables and patch panels.

Neutrik NL8 connectors

NL8FC	8 pole cable (female)
NL8MPR	8 pole panel (male)
NL8MM	8 pole inline coupler (male-male)

Connectors should be kept in good, clean condition to ensure full, undistorted loudspeaker performance. Worn, corroded or damaged pins and sockets can cause severe distortion or loss of signal.

Recommended loudspeaker cable

8-core cable is required for W8L/Longbows. Although some Wavefront series loudspeakers use less than 8 cores we recommend that rental companies standardise on 8-cores for all NL8 or PA-Con cables to avoid confusion when using a mixture of products in the Wavefront range.

The following table gives suitable copper core specifications for common applications:

**Cable run vs
copper core cross sectional area**



One W8L or Longbow

Up to 25m:	2.5mm ²
Up to 50m:	6mm ² (or 2 x 2.5mm ² cores in parallel using splitters at both ends)
Up to 100m:	10mm ² (or 2 x 6mm ² cores in parallel)

**Two W8Ls or Longbows
in parallel at the cluster**

Up to 12m:	2.5mm ²
Up to 25m:	6mm ² (or 2 x 2.5mm ² cores in parallel using splitters at both ends)
Up to 50m:	10mm ² (or 2 x 6mm ² cores in parallel)

Q. Why the odd sizes?

A. Loudspeaker cables are available in a limited range of standard copper core sizes ie. 1.5mm², 2.5mm², 4mm², 6mm², 10mm² and 35mm².

5.11 W8LC and W8LCD Quick Start Guide

Important note:

This information assumes the reader is an experienced sound system technician who is familiar with high quality, low noise system design and works to the internationally recognized 93/68/EEC Low Voltage Directive for mains safety. All rack systems should be fully PAT (Portable Appliance) tested for electrical safety before use.

What would a typical W8LC rack look like?

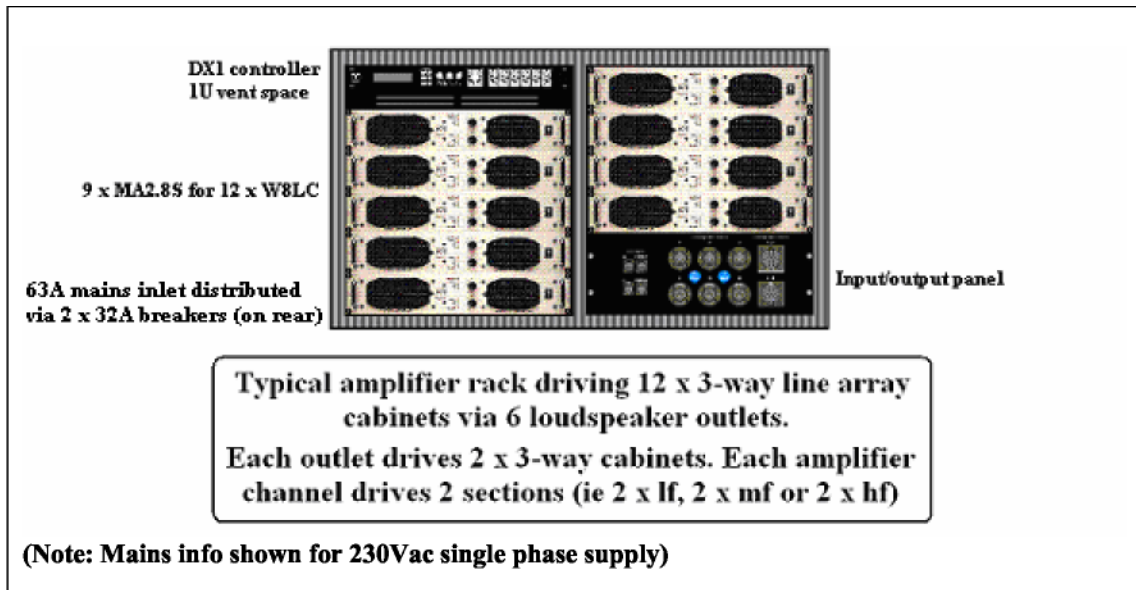

Can I parallel drive W8LC cabinets?

Yes. In normal systems W8LC cabinets are paralleled in pairs at the loudspeaker column using short link cables. All W8LC sections are 8 ohms. Each cable sees a two-speaker load so cables must be rated for a 4 ohm load. See cable recommendations later.

In theory it is possible to drive more than two cabinets in parallel using MA2.8S power amplifiers but sonic performance could suffer for the following reasons:

- 1) The rack mains current demand may cause mains voltages to drop or exceed the breaker ratings. The former would reduce sound quality, the latter would mute whole system sections.
- 2) Band zoning (the progressive shelving control applied to the upper mid & high frequency sections of line array columns to partially compensate for air absorption) will be in coarser steps. Coverage won't be as smooth.

How many amplifiers do I need to drive a typical W8LC system?

The simple rule of thumb is 3 power amplifiers for 4 W8LC cabinets...

3 x 2ch MA2.8S power amplifiers drive 4 x W8LC

6 x 2ch MA2.8S power amplifiers drive 8 x W8LC

9 x 2ch MA2.8S power amplifiers drive 12 x W8LC

12 x 2ch MA2.8S power amplifiers drive 16 x W8LC

Can I split the system into smaller racks with, say, 3 amps per rack?

Yes. But remember that our MA2.8S amplifier weighs less than 10kg so a double width rack housing 9 MA2.8S amplifiers for a standard 12-box system may be no heavier than a single rack system using conventional power amplifiers. A double width rack will cater for band zoning (the progressive shelving control applied to the upper mid & high frequency sections of line array columns to partially compensate for air absorption) without the need for dedicated master and slave racks linked with complicated multi-core links. See example of 3-amplifier master-slave rack system for a 12 W8LC system later.

Why do I need high power amplifiers for the mid & high frequency sections!?

There are several reasons for this:

- 1) Although vocal and percussive signals demand fairly low continuous power, their peak power can be much higher. Many touring systems have less than adequate peak power at mid and high frequencies and simply clip vocal fricatives and percussion transients producing poor mid and high frequency definition.
- 2) Our mid and high frequency sections are designed to reproduce these peak power transients faithfully without stress. We use carefully matched RC coupling networks to compensate for high frequency driver voice coil inductance. These coupling networks improve transient performance and present an easy load to the power amplifier whilst maintaining a high frequency efficiency of 109dB/W/m.
- 3) Line Arrays are designed for long throw applications. Air absorption can cause significant high frequency attenuation at low humidity. Line array columns are usually band zoned (ie progressive shelving control is applied to the upper mid & high frequency sections of line array columns to partially compensate for air absorption). This band zoning relies on the exceptional mid and high frequency performance provided by adequately powered high-efficient mid and high frequency sections.

Please note that our standard controller limiters are set with finite attack times. This

allows all them to pass transient signals to the full output capability of the MA2.8S without compression but to pull back to a suitable continuous power for sustained signals such as rail-to-rail feedback.

Although the long-term limiter thresholds are lower for the mid and high frequency sections (LF +5dBu, MF +1dBu, HF +1dBu), all W8LC sections are designed to accept full MA2.8S power on transients...

W8LC section	Max continuous demand	Max transient demand
Low frequency	760W	1500W
Mid frequency	301W	1500W
High frequency	301W	1500W

How much mains power will I need?

Many touring systems are supplied with inadequate mains power causing the system to sound like the PA equivalent of a portable radio with a flat battery!

Here are the current consumption figures for the recommended MA2.8S power amplifier. When used with our standard crossover and limiter settings.

230Vac operation to DX1 limiter threshold, 2 W8LC sections per channel: 5A
115Vac operation to DX1 limiter threshold, 2 W8LC sections per channel: 10A

A rack with 9 MA2.8S amplifiers (each driving 2 W8LC sections per channel for a total of 12 W8LC cabinets) will require a minimum of 45amps at 230Vac and 90amps at 115Vac under typical live sound conditions. We would recommend 63A at 230Vac and 120A at 115Vac.

Here are the MINIMUM figures for typical racks:

Number of W8LC Cabinets	Number of MA2.8S amplifiers	Minimum current	Minimum current
		for 230 Vac single phase mains	for 115Vac single phase mains
4	3	15A	30A
8	6	30A	60A
12	9	45A*	90A*
16	12	60A*	120A*

* Large racks are often supplied with 3-phase mains - e.g. a 9-amplifier rack may be wired with three MA2.8S amplifiers per phase and a 12-amplifier rack may be wired with four MA2.8S amplifiers per phase. The above minimum current figures may be divided by 3 when 3-phase mains is used.

How should I distribute mains power within the rack?

Normal distribution practice applies – e.g. a 230Vac inlet 63A inlet would be split into 2 x 32A spurs which would supply the appropriate outlet strips via 32A breakers.

Remember that, although the transient power demand will be the same for each W8LC section (see table earlier), medium to long-term power demand will be greater at lower frequencies. It is wise to spread the long-term current by supplying a mixture of low, mid and high frequency amplifiers from each breaker.

Single Phase Breaker (e.g. 32A Europe 63A USA)	4 x W8LC 3 x MA2.8S	8 x W8LC 6 x MA2.8S	12 x W8LC 9 x MA2.8S	16 x W8LC 12 x MA2.8S
A	1 LF, 1 MF, 1 HF, 1 DX1	1 LF, 1 MF, 1 HF	2 LF, 1 MF, 1 HF	2 LF, 1 MF, 1 HF
B		1 LF, 1 MF, 1 HF, 1 DX1	1 LF, 2 MF, 2 HF, 1 DX1	1 LF, 2 MF, 1 HF
C				1 LF, 1 MF, 2 HF, 1 DX1

Three Phase Breaker (e.g. 32A Europe 63A USA)	12 x W8LC 9 x MA2.8S	16 x W8LC 12 x MA2.8S
Phase A	1 LF, 1 MF, 1 HF	2 LF, 1 MF, 1 HF
Phase B	1 LF, 1 MF, 1 HF	1 LF, 2 MF, 1 HF
Phase C	1 LF, 1 MF, 1 HF, DX1	1 LF, 1 MF, 2 HF, 1 DX1

We recommend supplying each MA2.8S amplifier via a 16A cable and 16A single phase connector for 230Vac mains and via a 32A cable and 32A single phase connector and breaker for 115Vac mains. Please refer to the MA2.8S manual for further information.

Reminder:

This information assumes the reader is an experienced sound system technician who is familiar with high quality, low noise system design and works to the internationally recognized 93/68/EEC Low Voltage Directive for mains safety. All rack systems should be fully PAT (Portable Appliance) tested for electrical safety before use.

Why do I need a 6-output DX1 controller for a 3-way cabinet?

When line arrays are used for long throw applications air absorption can cause significant high frequency attenuation at low humidity. Progressive mid and high frequency shelving is applied to the upper zones of W8LC columns to partially compensate for this air absorption. This progressive shelving is called band-zoning

because one extra mid frequency band and two extra high frequency bands drive the upper zones of the line array.

Our standard W8LC presets configure the DX1 to produce these extra bands. This requires 6 outputs; 1 x LF, 2 x MF, 3 x HF. [See section 5.5.23.](#)

How do I patch my racks to take advantage of standard W8LC controller presets?

Standard W8LC presets configure DX1 outputs for the following controller-to-amplifier patches:

DX1 system controllers outputs are configured and patched as follows:

DX1 o/p	4 x W8LC	6 x W8LC	8 x W8LC	10 x W8LC	12 x W8LC	16 x W8LC
6 Upper HF			Upper 2 HF	Upper 4 HF	Upper 6 HF	Upper 10 HF
5 Middle HF	Upper 2 HF	Upper 4 HF	Middle 4 HF	Middle 4 HF	Middle 4 HF	Middle 4 HF
4 Lower HF	Lower 2 HF	Lower 2 HF	Lower 2 HF	Lower 2 HF	Lower 2 HF	Lower 2 HF
3 Upper MF		Upper 2 MF	Upper 4 MF	Upper 6 MF	Upper 8 MF	Upper 12 MF
2 Lower MF	All MF	Lower 4 MF	Lower 4 MF	Lower 4 MF	Lower 4 MF	Lower 4 MF
1 All LF	All LF	All LF	All LF	All LF	All LF	All LF

DX1 controllers have fully balanced inputs and outputs and MA series amplifiers operate with pin 2 hot. Racks will therefore be pin 2 hot – assuming that I/O panel-to-DX1 input and DX1 output-to-MA series amplifier input cables are wired 1-to-1 (X), 2-to-2 (L), 3-to-3 (R).

Standard balanced & screened XLR cables (typical spec = 70 ohms/1000m, 150pF/m core-core, 300pF/m core-core+screen) should be used between the panel and the DX1 input and between DX1 outputs and MA series amplifier inputs. Good EMC practice requires that XLR cable screens should be connected at both ends.

W8LC loudspeaker pin-out and cabling information appears later

Please note that the D-Sub connector on the rear of the DX1 is for loading Martin Audio control presets only. It does not facilitate PC equalizer control “on the fly”.

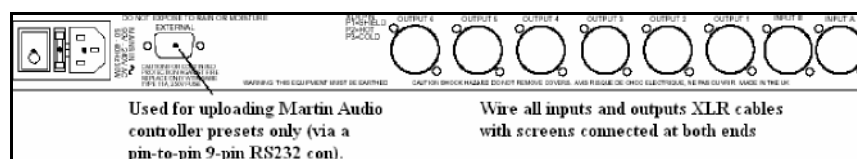

Controller-Amplifier Patching Examples

(For W8LC pin-outs and cabling see later)

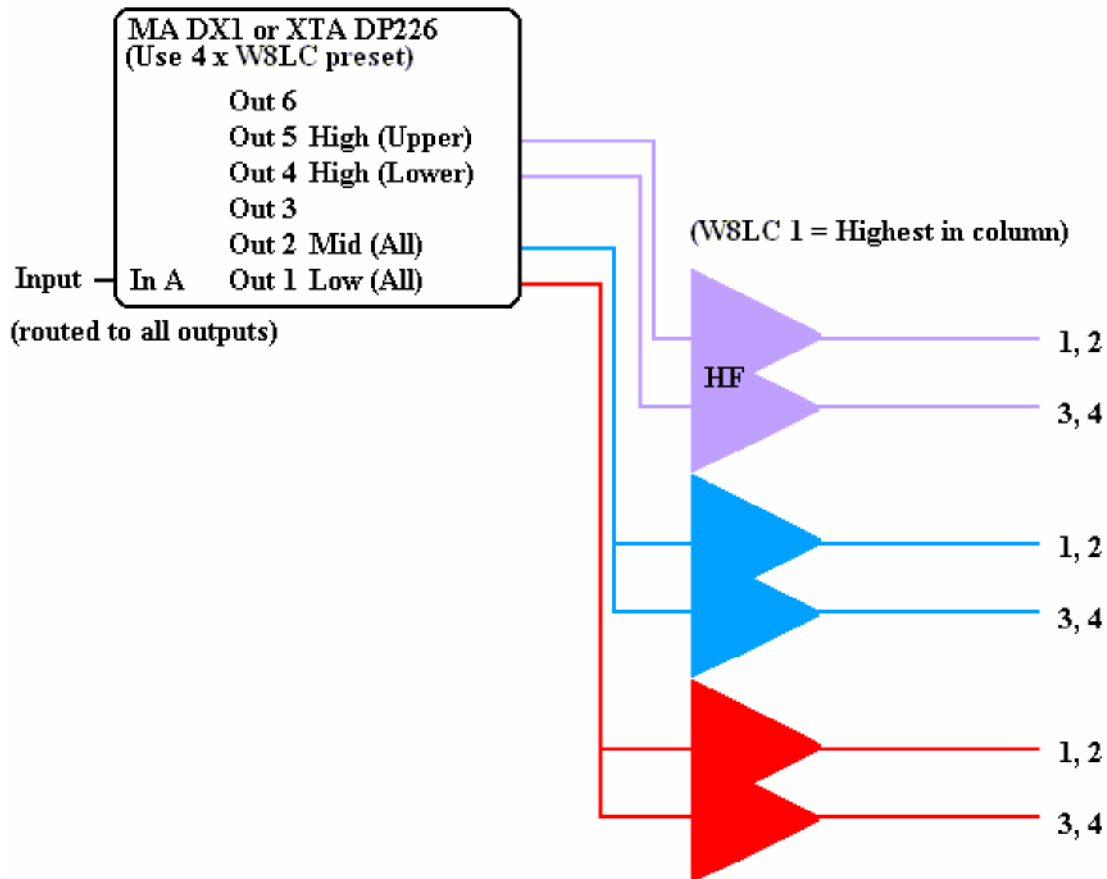

**System patch for 4 x W8LC array using
1 Martin Audio DX1 and 3 Martin Audio MA2.8S power amplifiers**

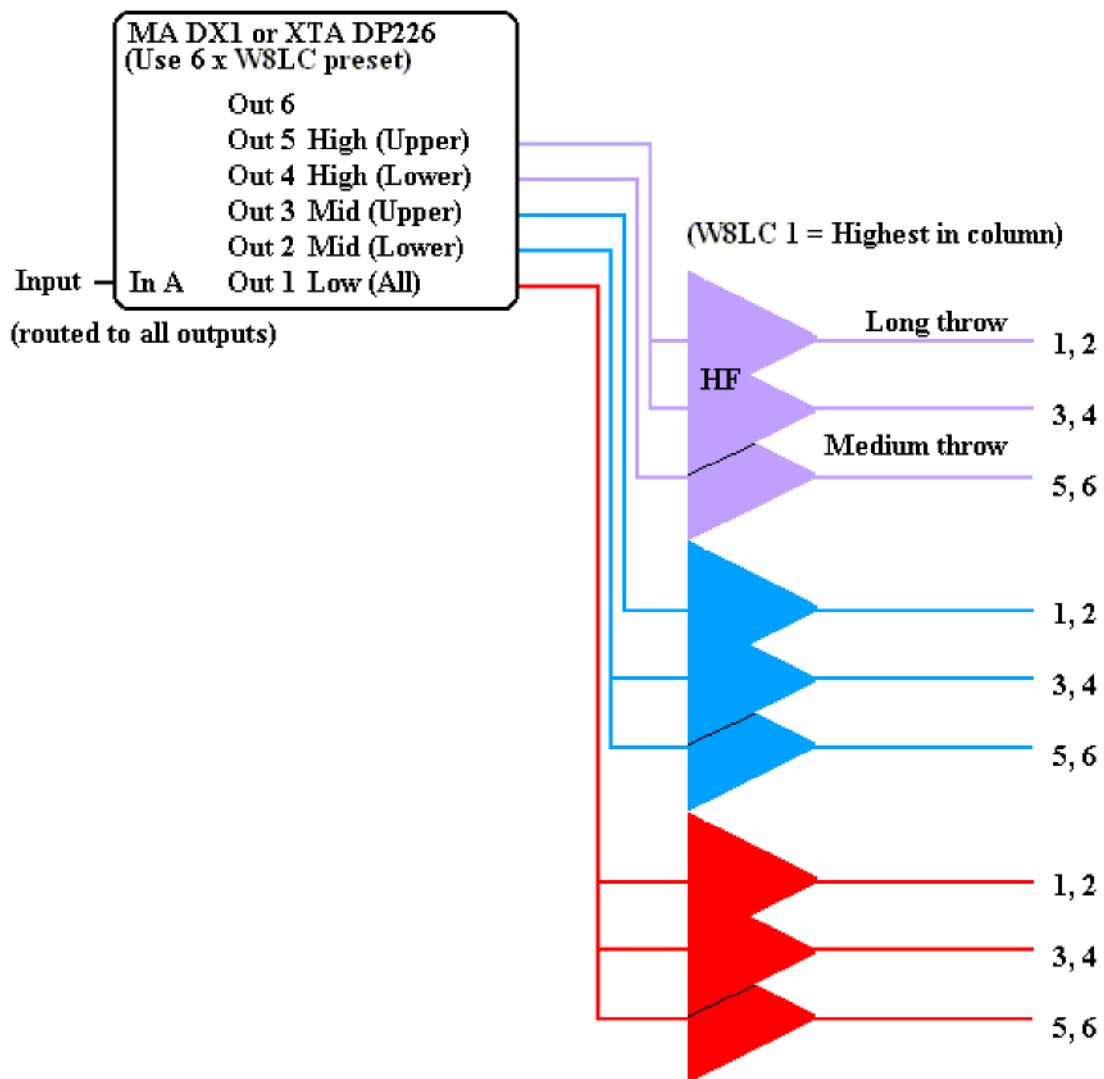

**System patch for 6 x W8LC array using
1 Martin Audio DX1 and 5 Martin Audio MA2.8S power amplifiers**

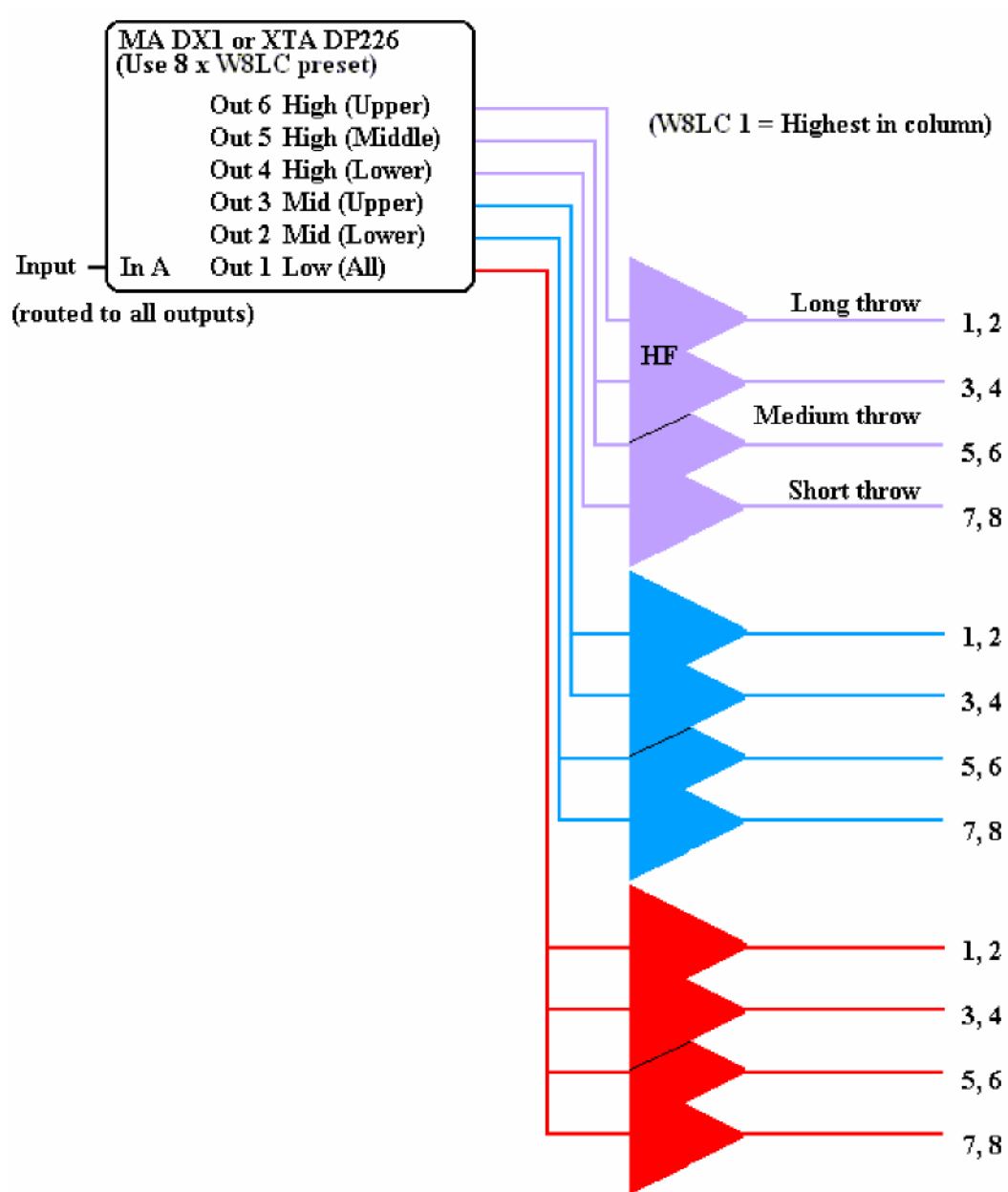

**System patch for 8 x W8LC array using
1 Martin Audio DX1 and 6 Martin Audio MA2.8S power amplifiers**

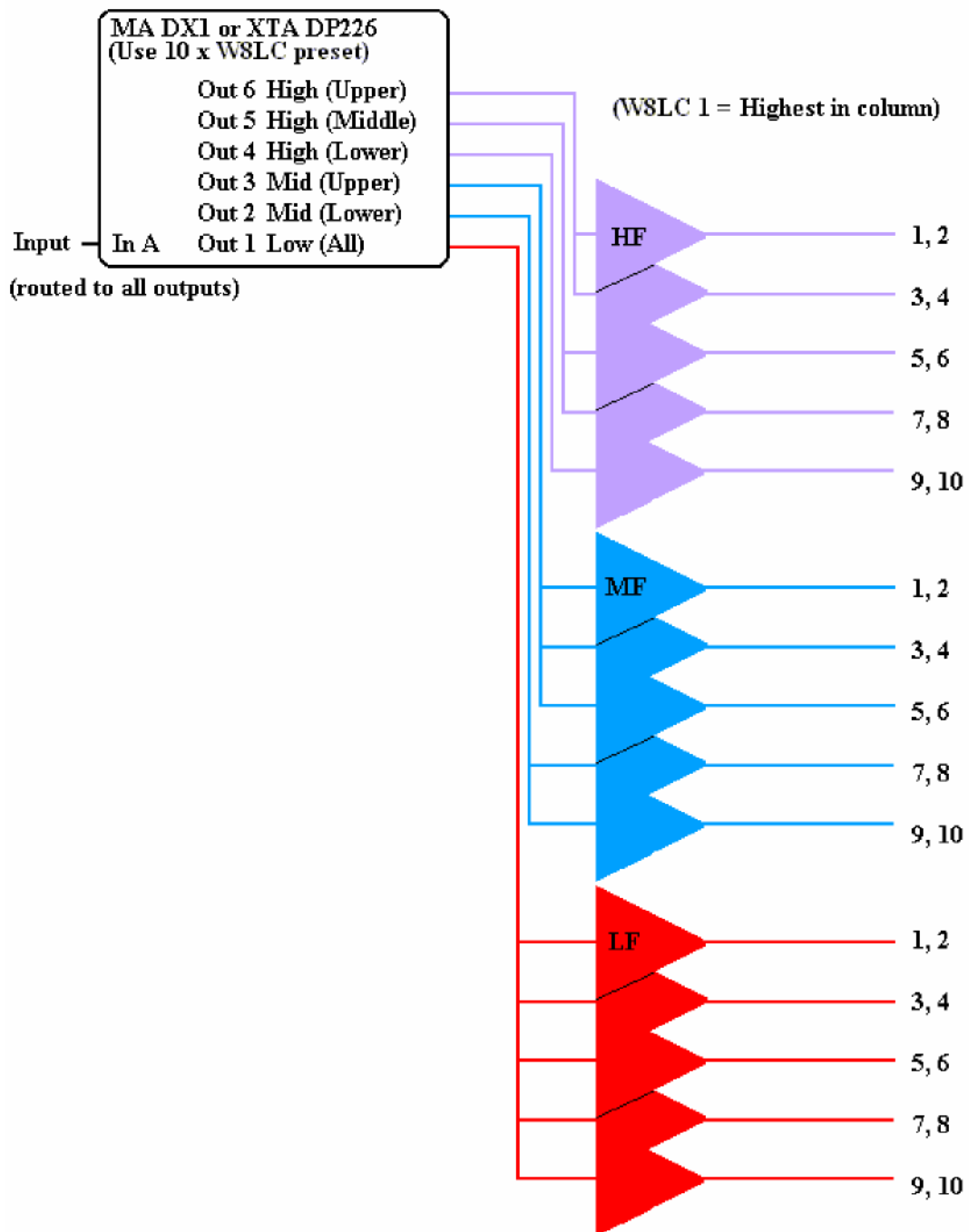

**System patch for 10 x W8LC array using
1 Martin Audio DX1 and 8 Martin Audio MA2.8S power amplifiers**

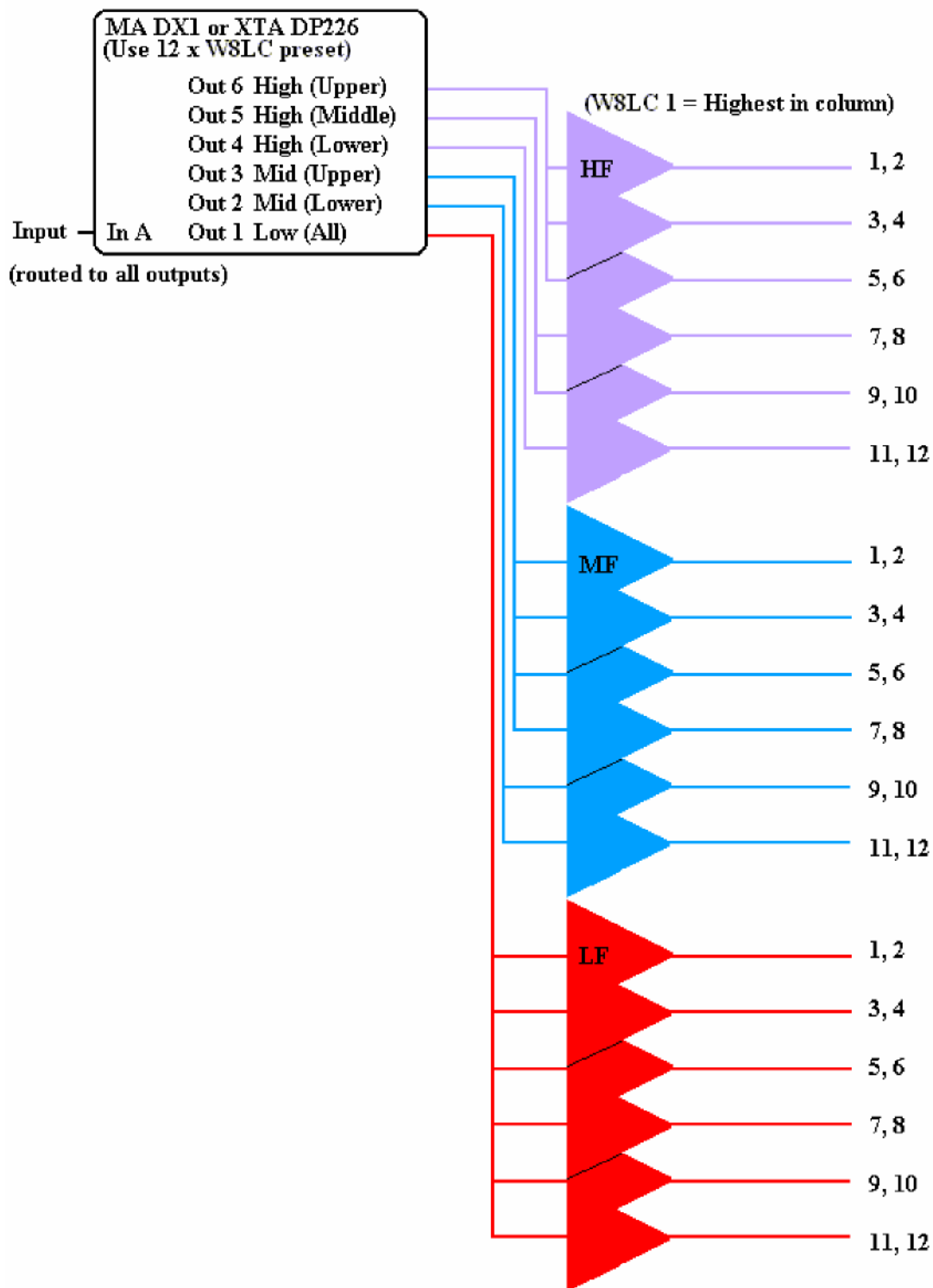

**System patch for 12 x W8LC array using
1 Martin Audio DX1 and 9 Martin Audio MA2.8S power amplifiers**

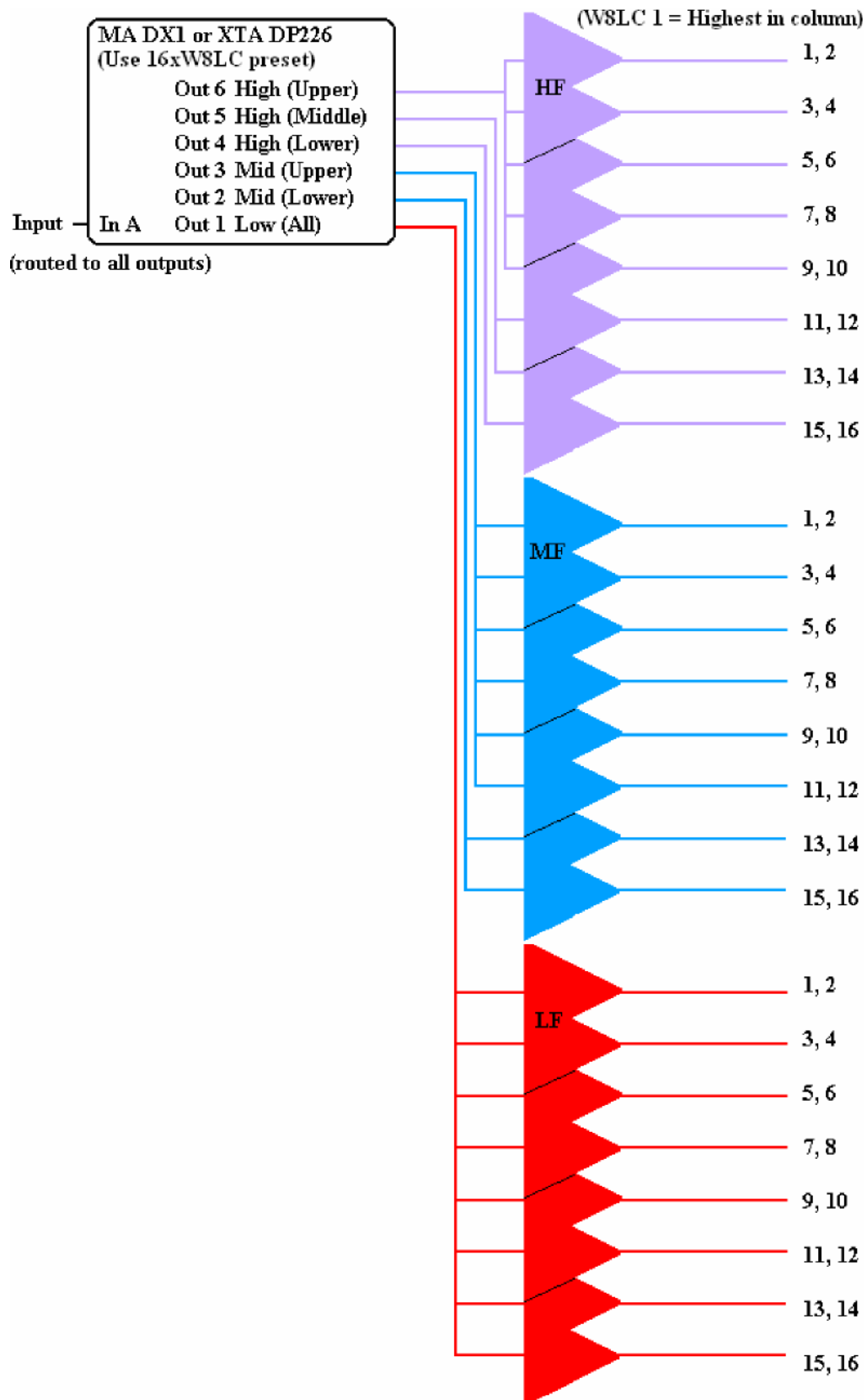

**System patch for 16 x W8LC array using
1 Martin Audio DX1 and 12 Martin Audio MA2.8S power amplifiers**

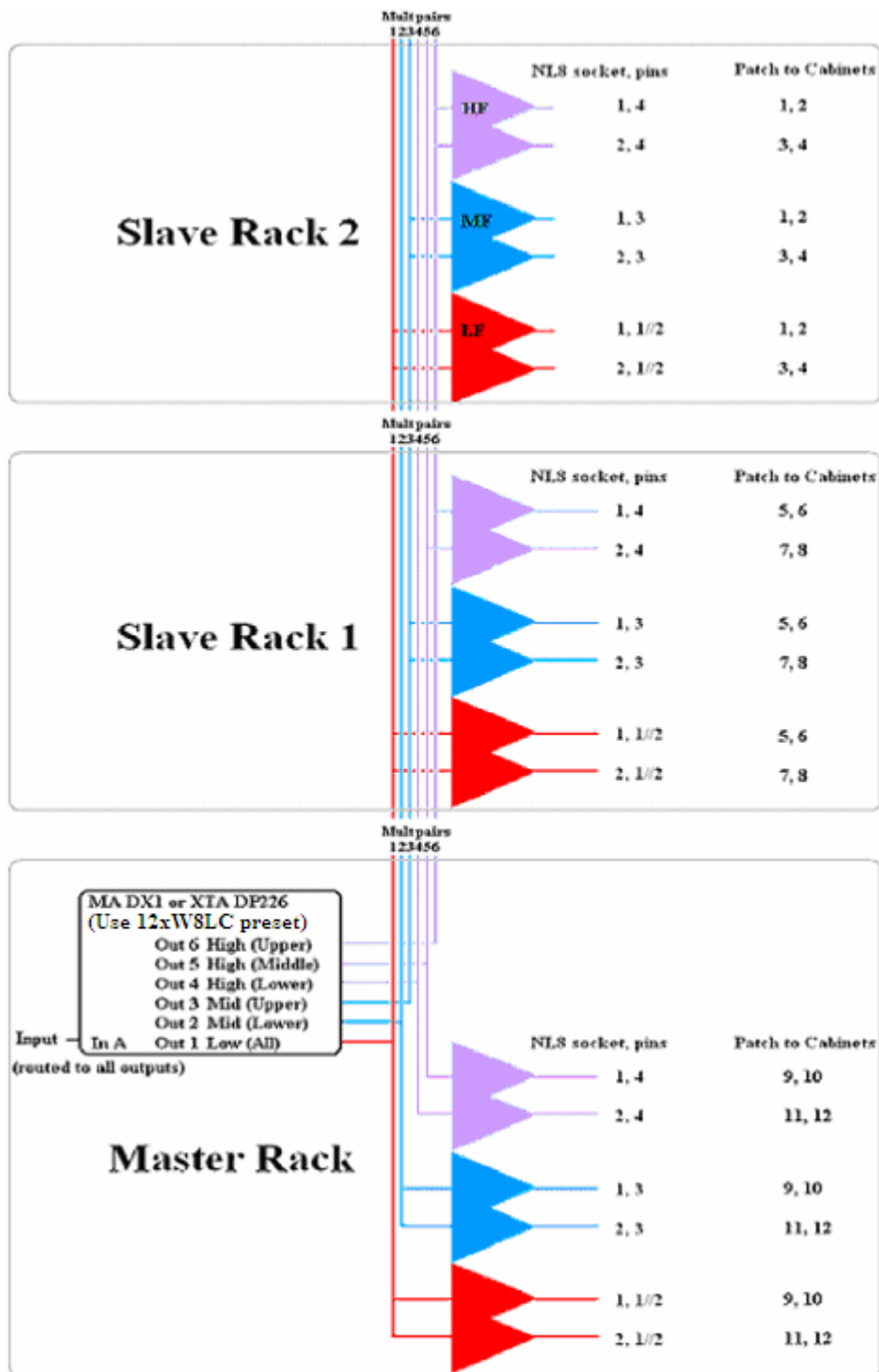

**System patch for 12 x W8LC system using
1 Martin Audio DX1 and 9 Martin Audio MA2.8S power amplifiers
arranged in 3-rack Master-Slave configuration**

W8LC + W8LCD combined system example using 6-way controllers with standard W8LC presets

Regular W8LC rental companies may wish to use this type of configuration so that they can simply add one extra L-R down-fill controller (plus the required amplifier channels) to their standard W8LC racks.

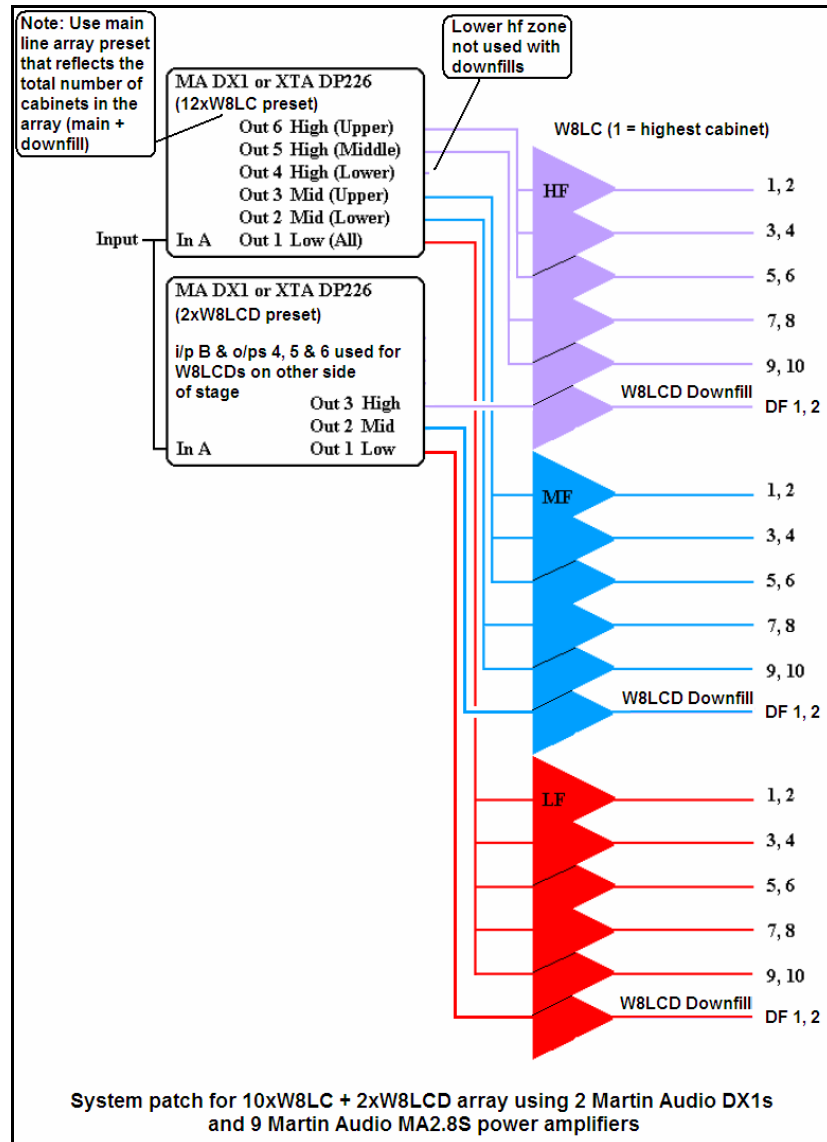

Important notes for all W8LC + W8LCD systems:

- ✚ Fly the UPPER W8LCD from the 6° hole in the W8LC.
- ✚ Fly the LOWER W8LCD from the 20° hole in the W8LCD above.
- ✚ Make sure the switches on the back of the W8LCDs are set to the correct positions...
 - In the UPPER/SINGLE position for the upper W8LCD
 - In the LOWER position for the lower W8LCD
- ✚ The lower W8LC MF & HF band zones are not used as the W8LCD takes over their nearfield role.

W8LC + W8LCD systems using a single 6-way controller per side with new W8LCD + W8LC presets.

These patch configurations take advantage of the fact that the W8LCD LF can be driven with the same signal as a standard W8LC.

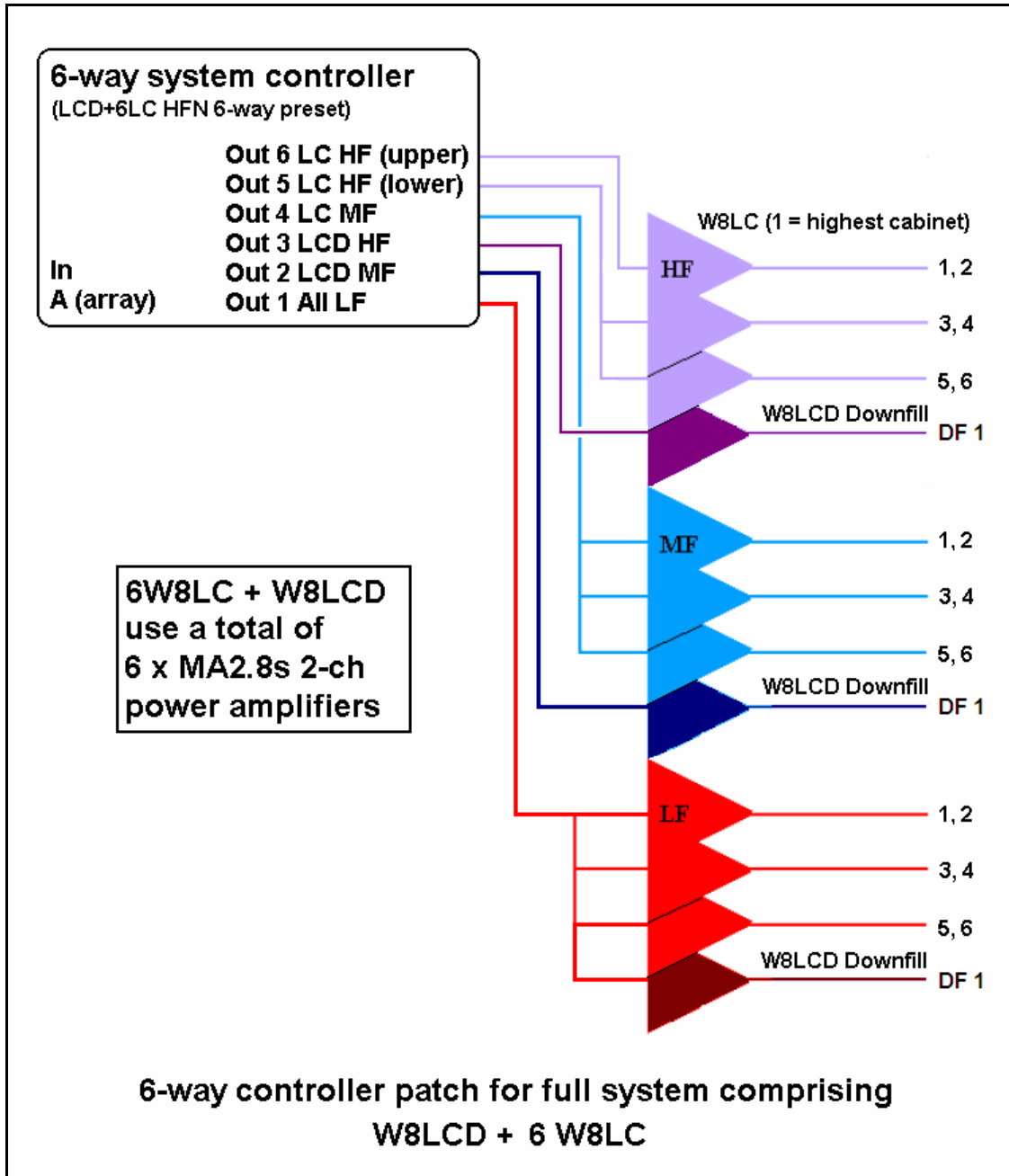

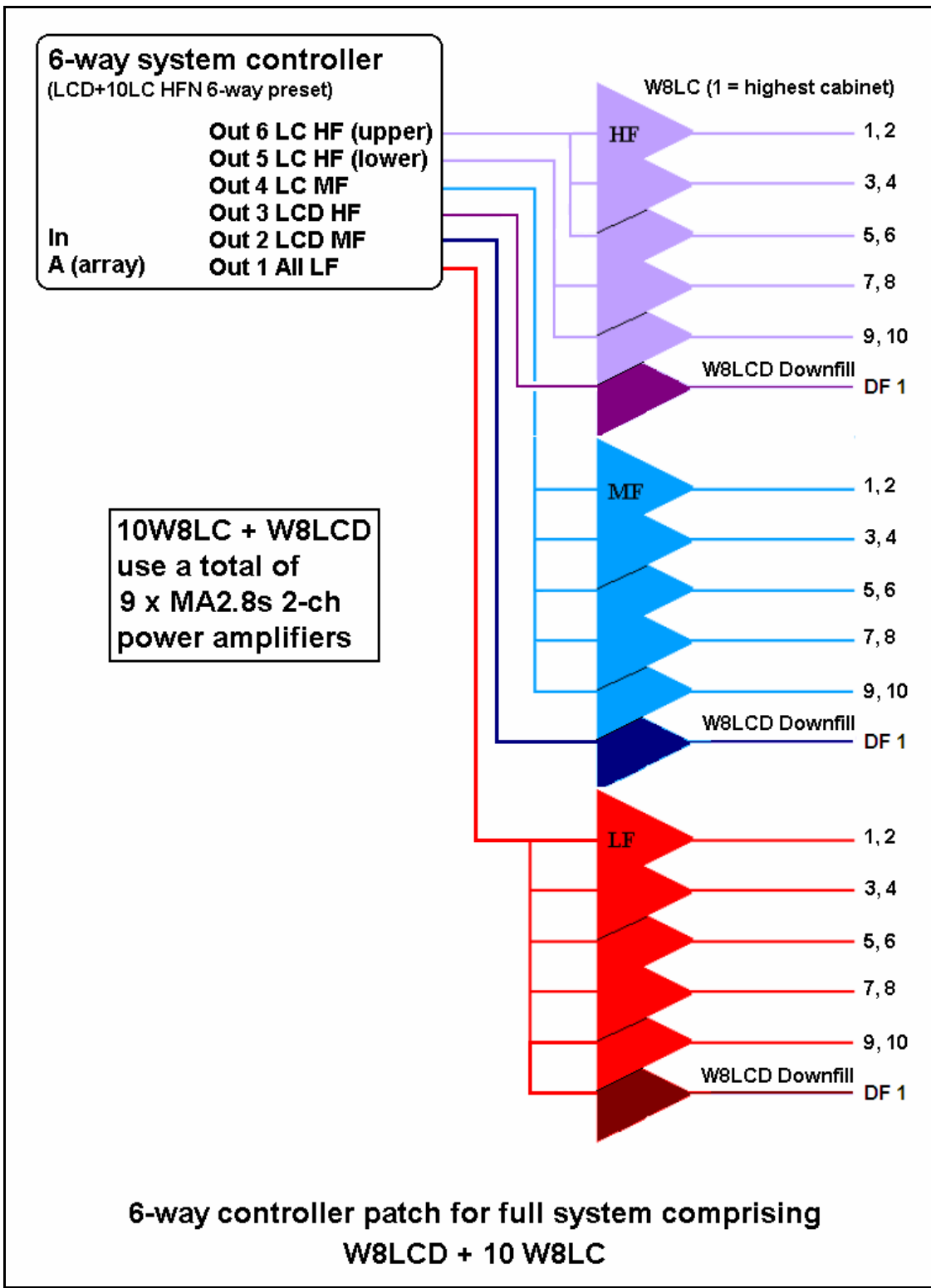

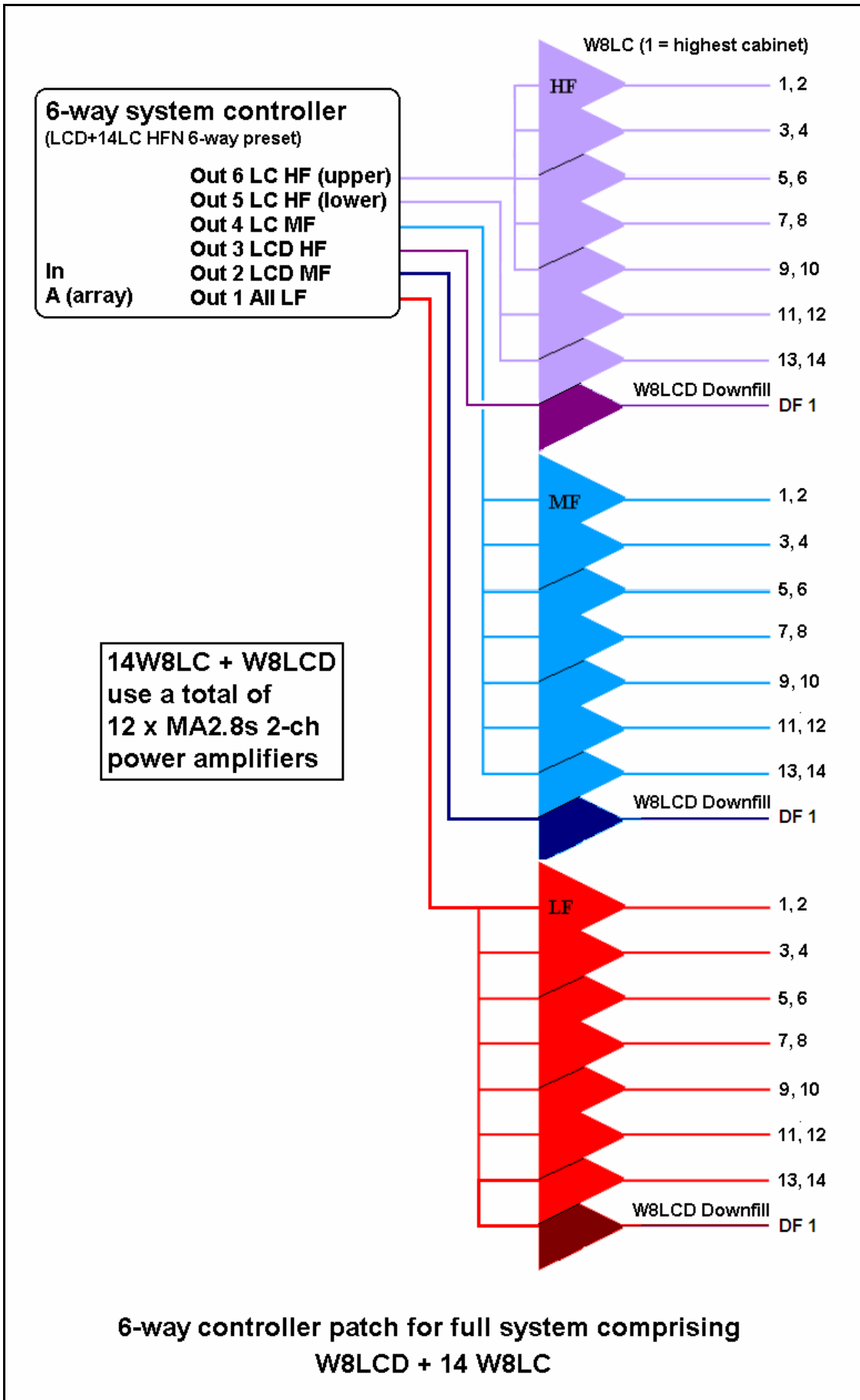

Full WLX + W8LCD + W8LC system examples using 8-way DX2 controller combination presets

8-way controllers can provide the patch configurations required to provide a full system comprising subwoofers, down-fills (with separate control of all bands) plus, of course, the main array.

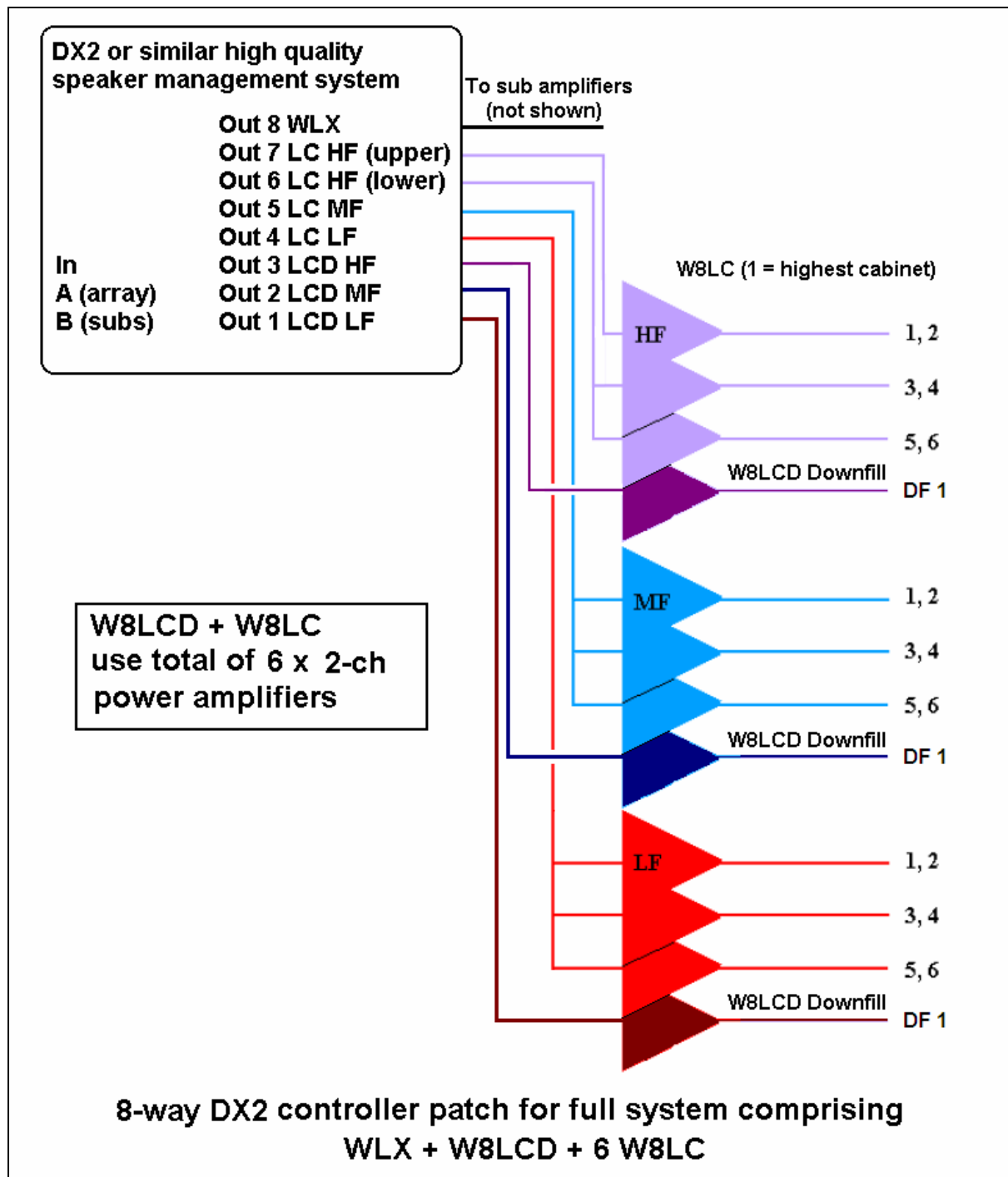

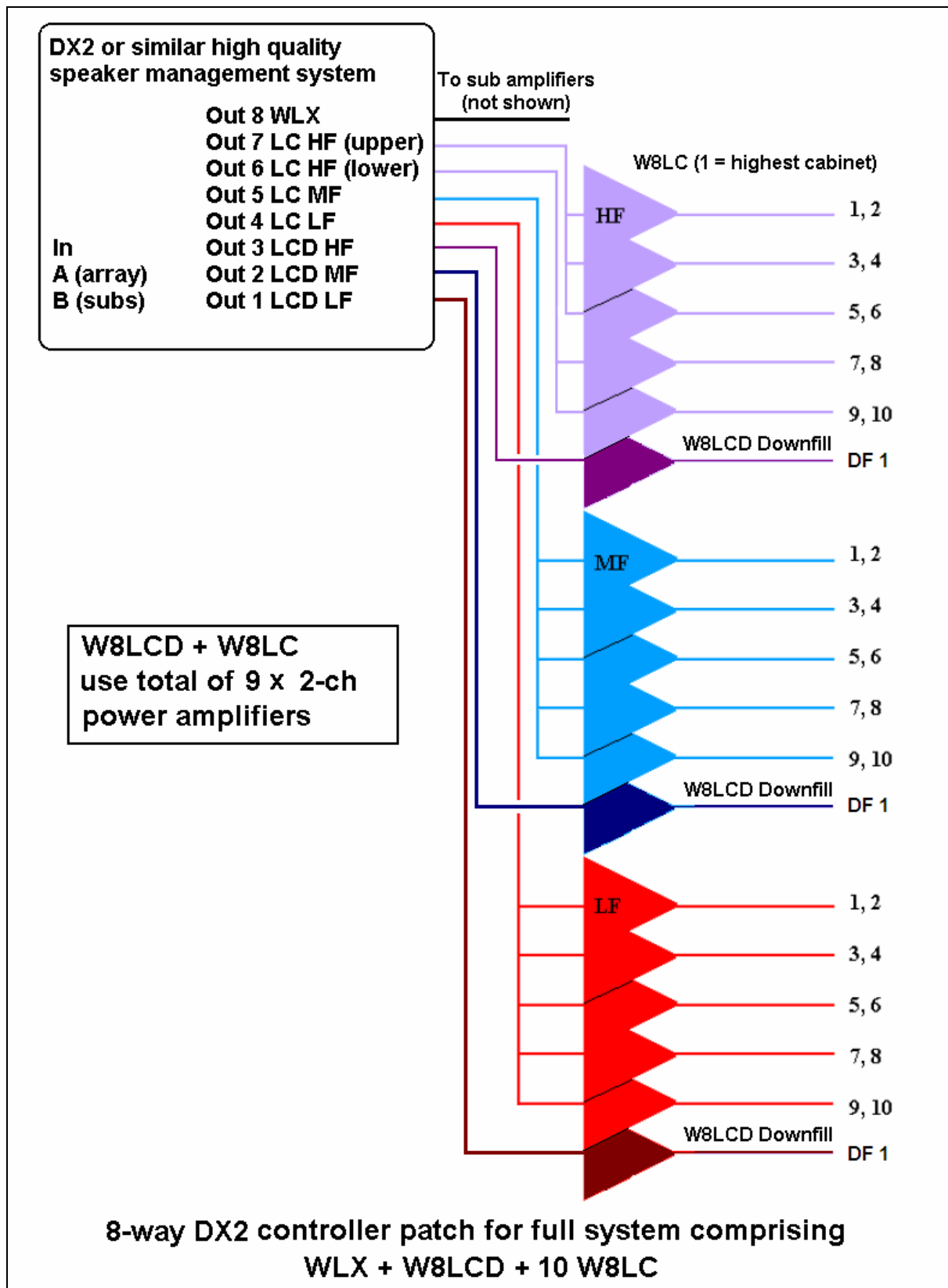

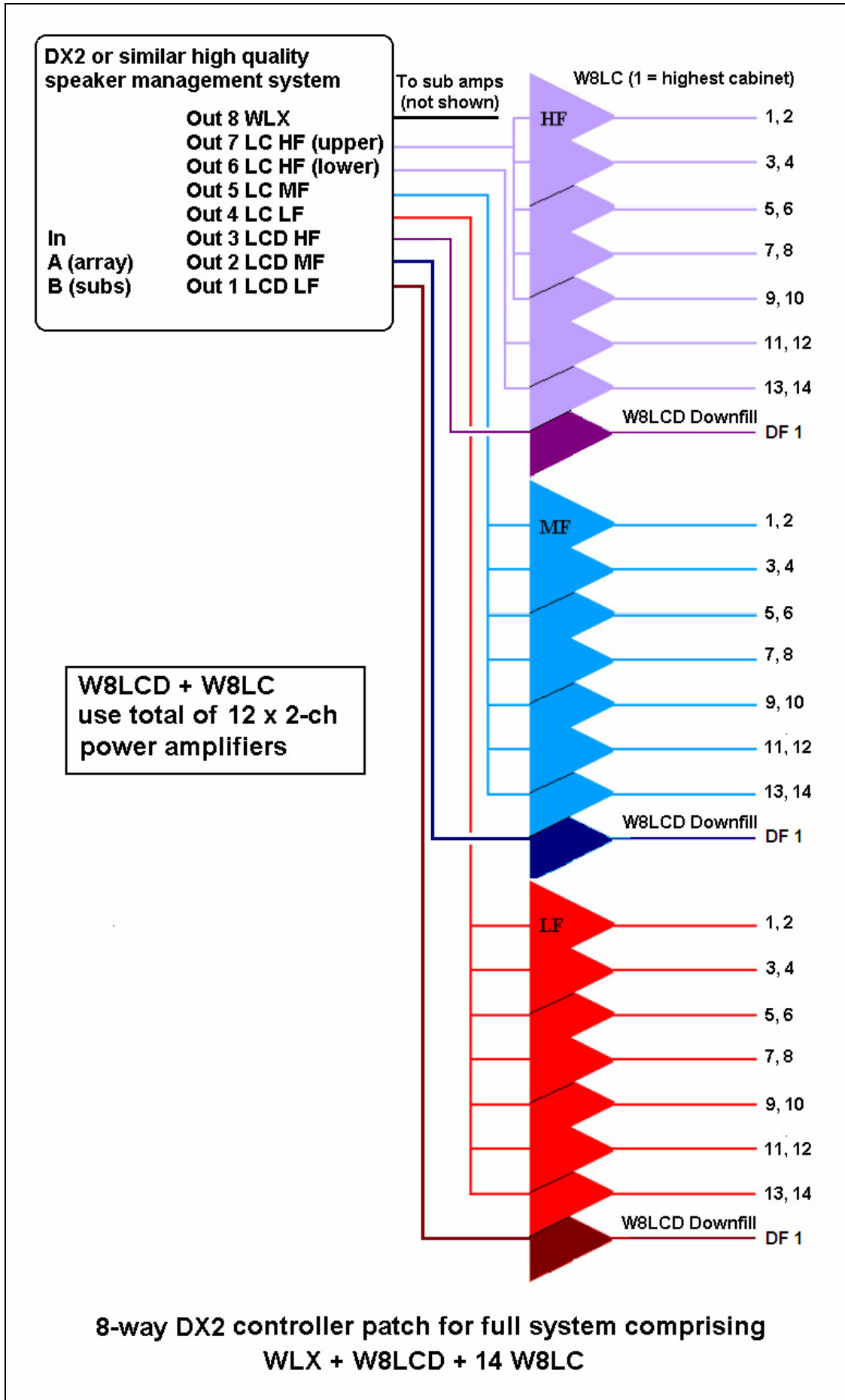

W8LC Pin-outs and cabling

Important Note:

MA2.8S power amplifier output NL4 connectors carry both channels (e.g. pins +1/-1 = Ch1, +2/-2 = Ch2).

Always use NL2 connectors for power amplifier outputs to avoid mismatching.

W8LC		
Connector	Connector	Function
NL8	PA-Con	W8LC
+1	A	Low +
-1	B	Low -
+2	C	Low +
-2	D	Low -
+3	E	Mid +
-3	F	Mid -
+4	G	High +
-4	H	High -

Neutrik Cable and panel connector part numbers

Please note the following part numbers when ordering loudspeaker connectors to make up NL8 cables and patch panels:

Neutrik NL8 connectors	
NL8FC	8 pole cable (female)
NL8MPR	8 pole panel (male)
NL8MM	8 pole inline coupler (male-male)

Connectors should be kept in good, clean condition to ensure full, undistorted loudspeaker performance. Worn, corroded or damaged pins and sockets can cause severe distortion or loss of signal.

Recommended loudspeaker cable

8-core cable is required for W8LCs. Although some Wavefront series loudspeakers use less than 8 cores we recommend that rental companies standardise on 8-cores for

all NL8 or PA-Con cables to avoid confusion when using a mixture of products in the Wavefront range.

The following table gives suitable copper core specifications for common applications:

The following table gives suitable copper core specifications for common applications:

**Cable run vs
copper core cross sectional area**



One W8LC

Up to 25m:	2.5mm ²
Up to 50m:	6mm ² (or 2 x 2.5mm ² cores in parallel using splitters at both ends)
Up to 100m:	10mm ² (or 2 x 6mm ² cores in parallel)

Two W8LCs in parallel at the cluster

Up to 12m:	2.5mm ²
Up to 25m:	6mm ² (or 2 x 2.5mm ² cores in parallel using splitters at both ends)
Up to 50m:	10mm ² (or 2 x 6mm ² cores in parallel)

Q. Why the odd sizes?

A. Loudspeaker cables are available in a limited range of standard copper core sizes ie. 1.5mm², 2.5mm², 4mm², 6mm², 10mm² and 35mm².

5.12 W8LM Quick Start Guide

Important note:

This information assumes the reader is an experienced sound system technician who is familiar with high quality, low noise system design and works to the internationally recognized 93/68/EEC Low Voltage Directive for mains safety. All rack systems should be fully PAT (Portable Appliance) tested for electrical safety before use.

What would typical W8LM racks look like?

DX1 controller
1U vent space

3 x MA2.8S amplifiers for
12 x bi-amped W8LM

Input/output panel

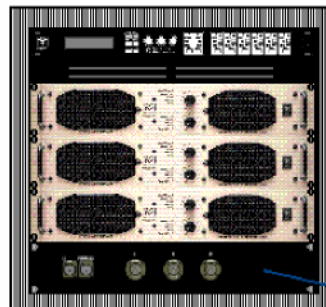

32A 230Vac or
63A 115Vac
single-phase
mains inlet
here

**Typical amplifier rack driving 12 x bi-amped W8LM cabinets via 3 loudspeaker outlets.
Each amplifier channel drives 4 low frequency or 4 mid-high frequency sections in parallel.
Each 2-ch amplifier drives 1 outlet.
Each outlet drives 4 x bi-amped cabinets.**

DX1 controllers
(2 for stereo or
1 for mono)
1U vent space

3 x MA2.8S amplifiers for
12 x bi-amped W8LM

Input/output panel

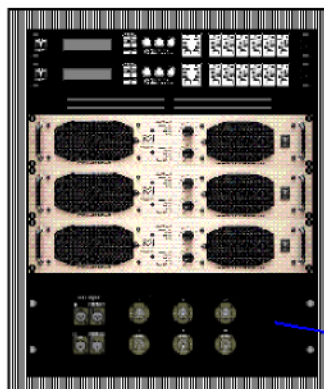

32A 230Vac or
63A 115Vac
single-phase
mains inlet
here

**Typical amplifier rack driving 24 passive W8LM cabinets via 3 loudspeaker outlets.
Each amplifier channel drives 4 passive cabinets in parallel.
Each 2-ch amplifier drives 8 passive cabinets via 2 outlets.**

Can I parallel drive W8LM cabinets?

Yes. In normal systems up to four W8LM cabinets are paralleled at the loudspeaker column using short link cables. All W8LM sections are 12 ohms. Each cable drives up to four speaker loads so cables must be rated for 3 ohms. See cable recommendations later.

How many amplifiers do I need to drive a typical W8LM system?

It depends whether you drive your W8LMs bi-amped or passive (determined by a switch on the rear of the W8LM). Bi-amped mode provides a slightly smoother mid-frequency response and greater mid-band headroom but uses more power amplifiers.

Bi-amped

1 power amplifier for 4 bi-amped W8LM cabinets...

1 x 2ch MA2.8S power amplifiers drive 4 x bi-amped W8LM

2 x 2ch MA2.8S power amplifiers drive 8 x bi-amped W8LM

3 x 2ch MA2.8S power amplifiers drive 12 x bi-amped W8LM

4 x 2ch MA2.8S power amplifiers drive 16 x bi-amped W8LM

Passive

1 power amplifier for 8 passive W8LM cabinets...

1 x 2ch MA2.8S power amplifiers drive 8 x passive W8LM

2 x 2ch MA2.8S power amplifiers drive 16 x passive W8LM

3 x 2ch MA2.8S power amplifiers drive 24 x passive W8LM

4 x 2ch MA2.8S power amplifiers drive 32 x passive W8LM

Why do I need high power amplifiers for the high frequency sections!?

There are several reasons for this:

- 1) Although vocal and percussive signals demand fairly low continuous power, their peak power can be much higher. Many touring systems have less than adequate peak power at mid and high frequencies and simply clip vocal fricatives and percussion transients producing poor mid and high frequency definition.
- 2) Our mid and high frequency sections are designed to reproduce these peak power transients faithfully without stress. We use carefully matched RC coupling networks to compensate for high frequency driver voice coil inductance. These coupling networks improve transient performance and present an easy load to the power amplifier.

3) Line Arrays are designed for long throw applications. Air absorption can cause significant high frequency attenuation at low humidity. Line array columns are usually band zoned (ie progressive shelving control is applied to the upper mid & high frequency sections of line array columns to partially compensate for air absorption). This band zoning relies on the exceptional mid and high frequency performance provided by adequately powered high-efficient mid and high frequency sections.

Please note that our standard controller limiters are set with finite attack times. This allows all them to pass transient signals to the full output capability of the MA2.8S without compression but to pull back to a suitable continuous power for sustained signals such as rail-to-rail feedback.

Parallel W8LM sections	Max continuous demand	Max transient demand
Low-mid	760W	1500W
High	142W	1500W

How do I patch my racks to take advantage of standard W8LM controller presets?

W8LM presets 20-39 configure Martin Audio DX1 or XTA DP226 outputs for the following active (as shown) or passive (using low-mid output) controller-to-amp patches:

DX1 or DP226 input	DX1 or DP226 output	2 x W8LM (Stereo)	4 x W8LM (Stereo)	6 x W8LM (Mono)	8 x W8LM (Mono)	12 x W8LM (Mono)
A/(*B stereo)	6	Right* High	Right* High			Upper 4 High
A/(*B stereo)	5	Right* Low-mid	Right* Low-mid	Upper 2 High	Upper 4 High	Middle 4 High
A/(*B stereo)	4	Optional R* WLX sub	Optional R* WLX sub	Lower 4 High	Lower 4 High	Lower 4 High
A	3	Left High	Left High	Upper 2 Low-mid	Upper 4 Low-mid	Upper 8 Low-mid
A	2	Left Low-mid	Left Low-mid	Lower 4 Low-mid	Lower 4 Low-mid	Lower 4 Low-mid
A	1	Optional L WLX sub	Optional L WLX sub	Optional WLX sub	Optional WLX sub	Optional WLX sub

Alternative W8LM +WLX presets (40-49) are now available. These provide active W8LM settings with a separate subwoofer signal chain via input B and output 6:

DX1 or DP226 Input	DX1 or DP226 Output	6xW8LM+WLX (Mono)	8xW8LM+WLX (Mono)	12xW8LM+WLX (Mono)
B	6 Subs (Default = WLX)	WLX	WLX	WLX
A	5 Upper High			Upper 4 High
A	4 Middle High	Upper 2 High	Upper 4 High	Middle 4 High
A	3 Lower High	Lower 4 High	Lower 4 High	Lower 4 High
A	2 Upper Low-mid	Upper 2 Low-mid	Upper 4 Low-mid	Upper 8 Low-mid
A	1 Lower Low-mid	Lower 4 Low-mid	Lower 4 Low-mid	Lower 4 Low-mid

Band Zoning

W8LM band zoning is from the bottom upwards as follows:

Low-mid frequencies

- Bottom 4 cabinets in the lower zone
- The rest of the cabinets in the upper zone

High frequencies

- Bottom 4 cabinets in the lower zone
- Up to 4 cabinets in the middle zone
- The rest of the cabinets in the upper zone

DX1 controllers have fully balanced inputs and outputs and MA series amplifiers operate with pin 2 hot. Racks will therefore be pin 2 hot – assuming that I/O panel-to-DX1 input and DX1 output-to-MA series amplifier input cables are wired 1-to-1 (X), 2-to-2 (L), 3-to-3 (R). The old U.S. standard was never XLR, it was XRL!

Standard balanced & screened XLR cables (typical spec = 70 ohms/1000m, 150pF/m core-core, 300pF/m core-core+screen) should be used between the panel and the DX1 input and between DX1 outputs and MA series amplifier inputs. Good EMC practice requires that XLR cable screens should be connected at both ends.

Please note that the D-Sub connector on the rear of the DX1 is for loading Martin Audio control presets only. It does not facilitate PC equalizer control “on the fly”.

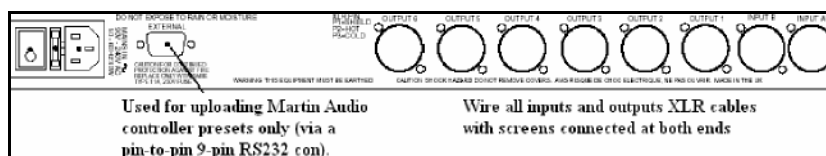

Rack patch examples – 4 x W8LM/LMD arrays

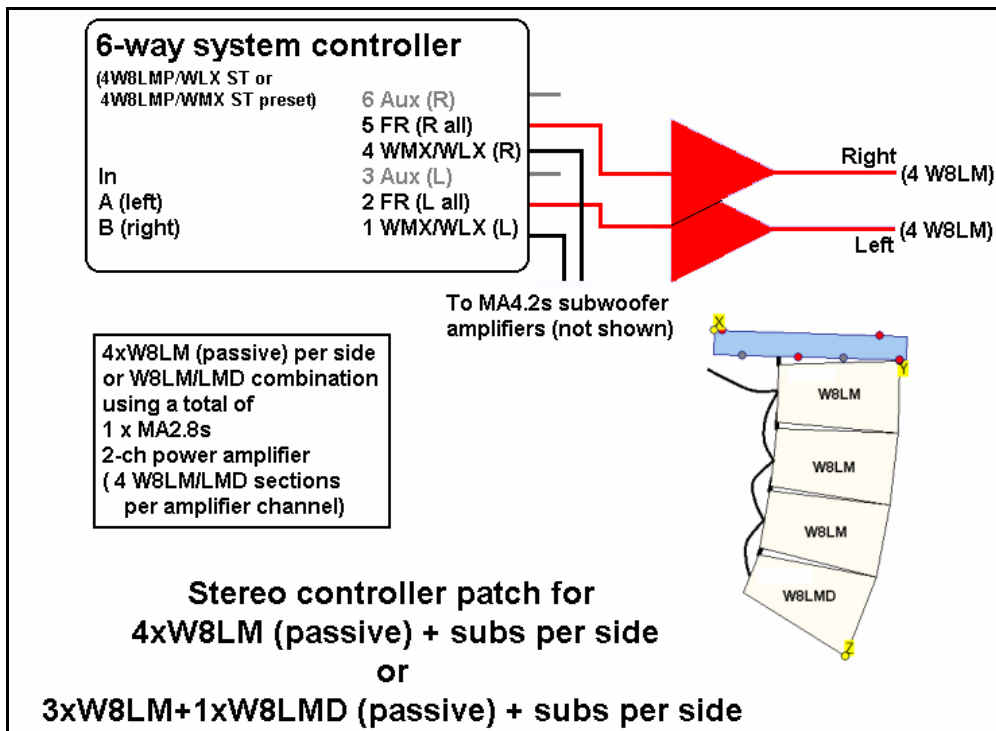
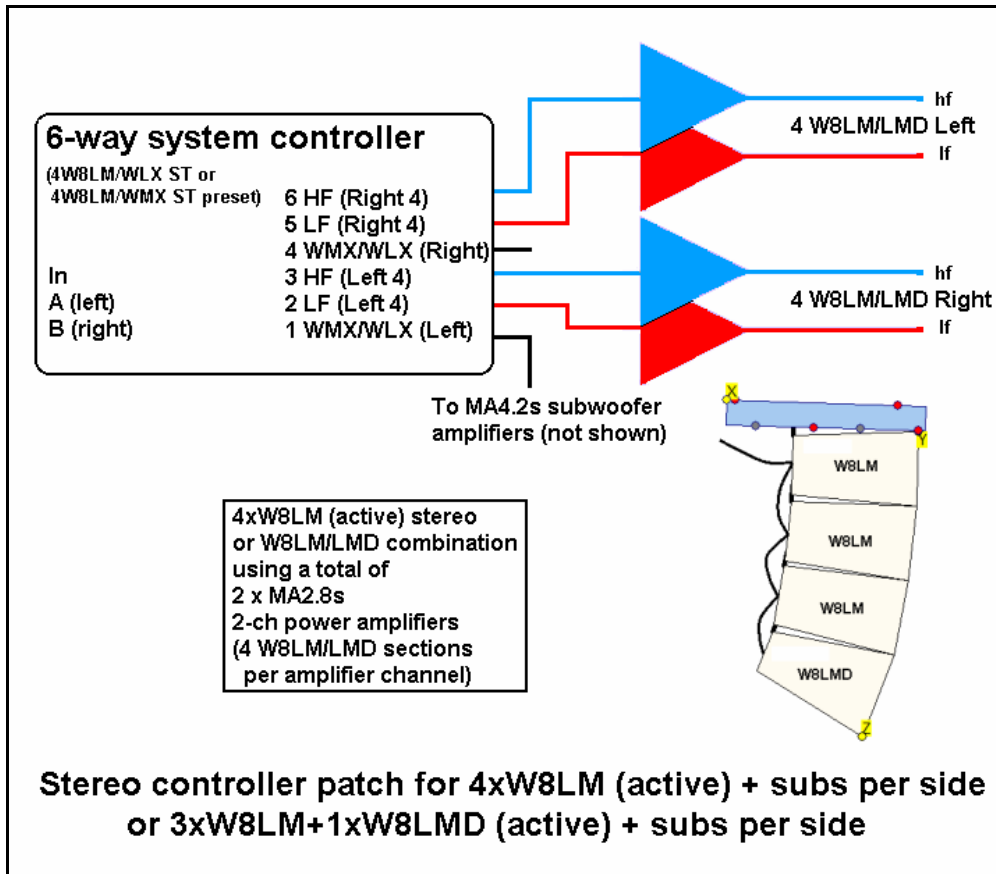

Rack patch examples – 8 x W8LM/LMD arrays

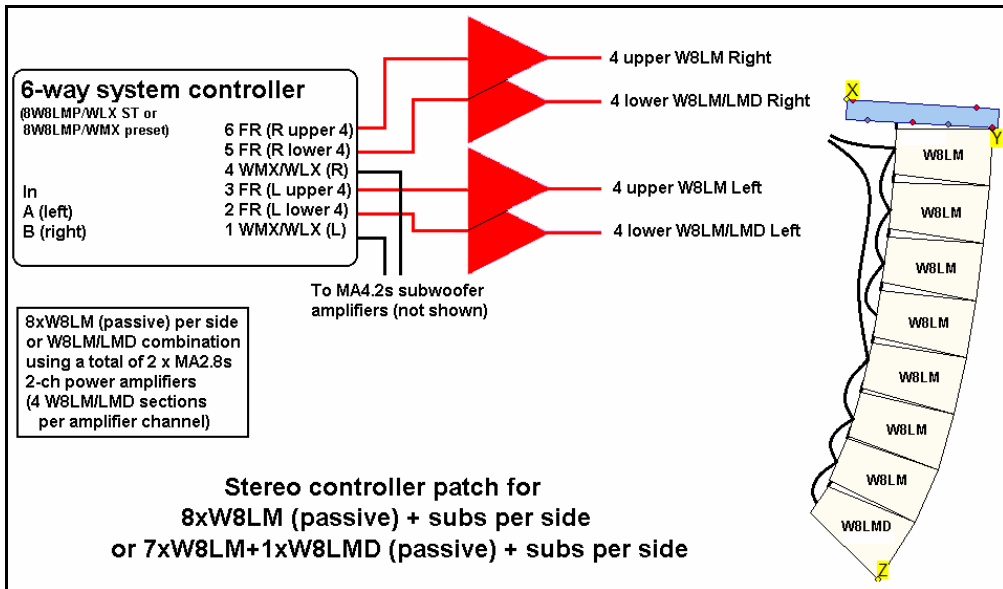
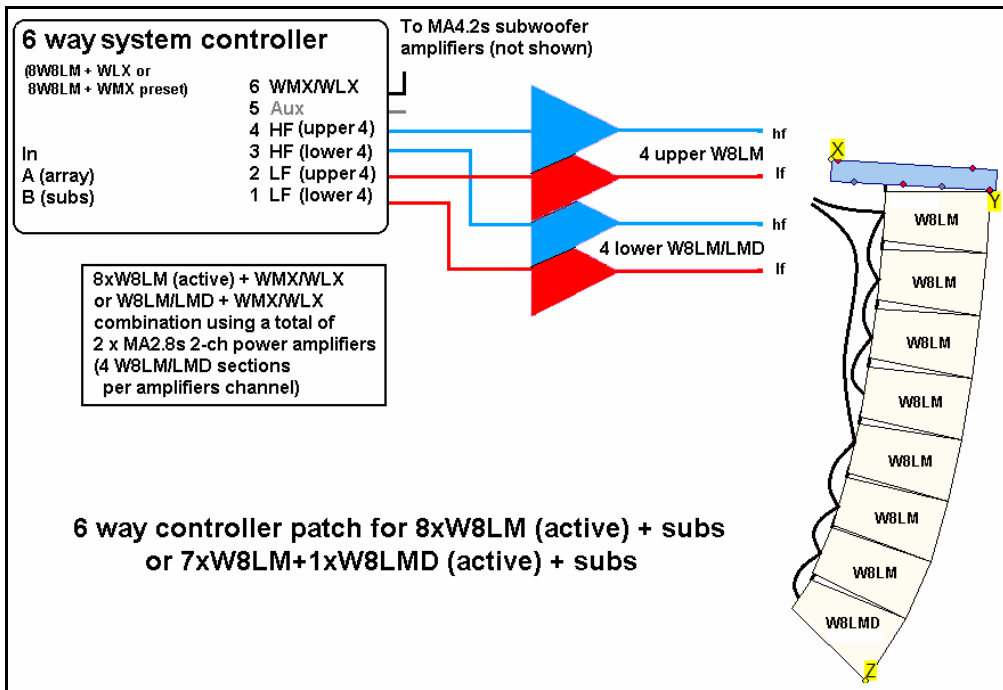

Rack patch examples – 12 x W8LM/LMD arrays

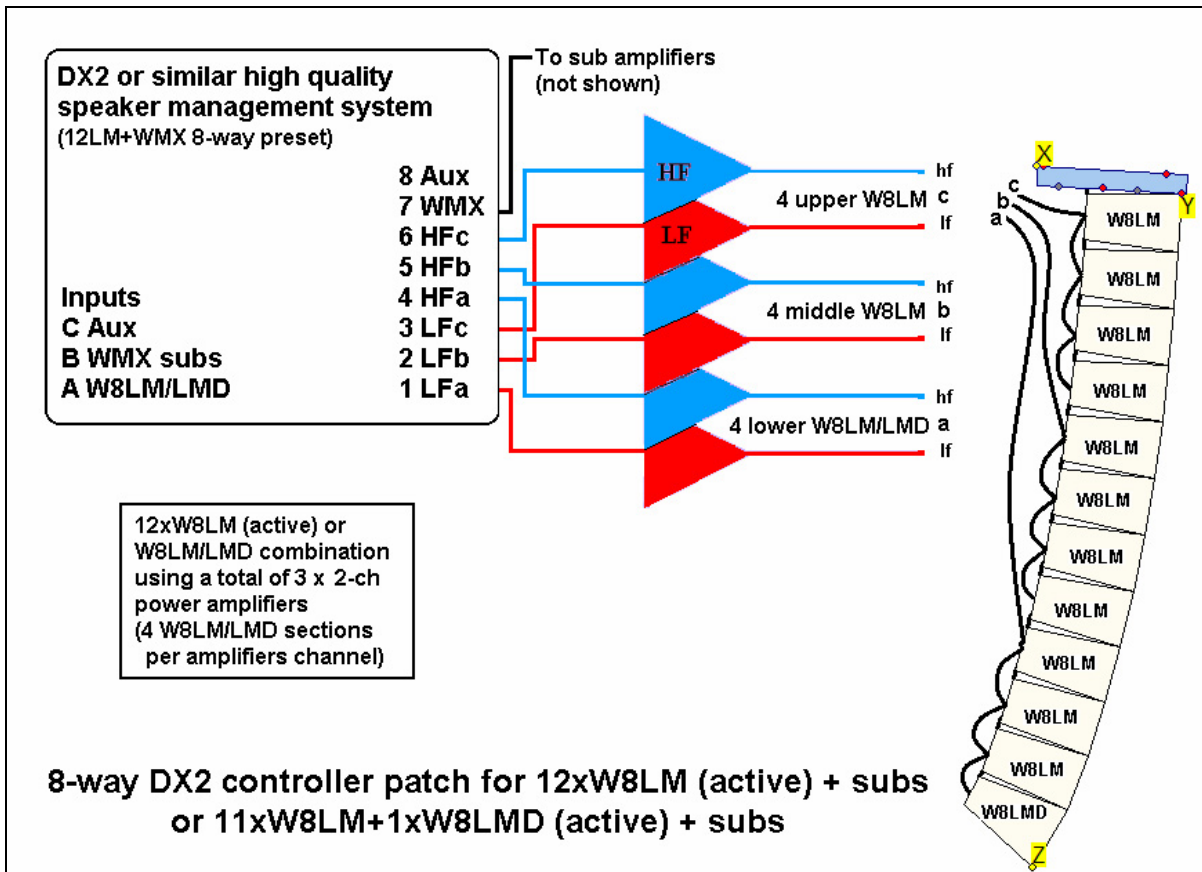
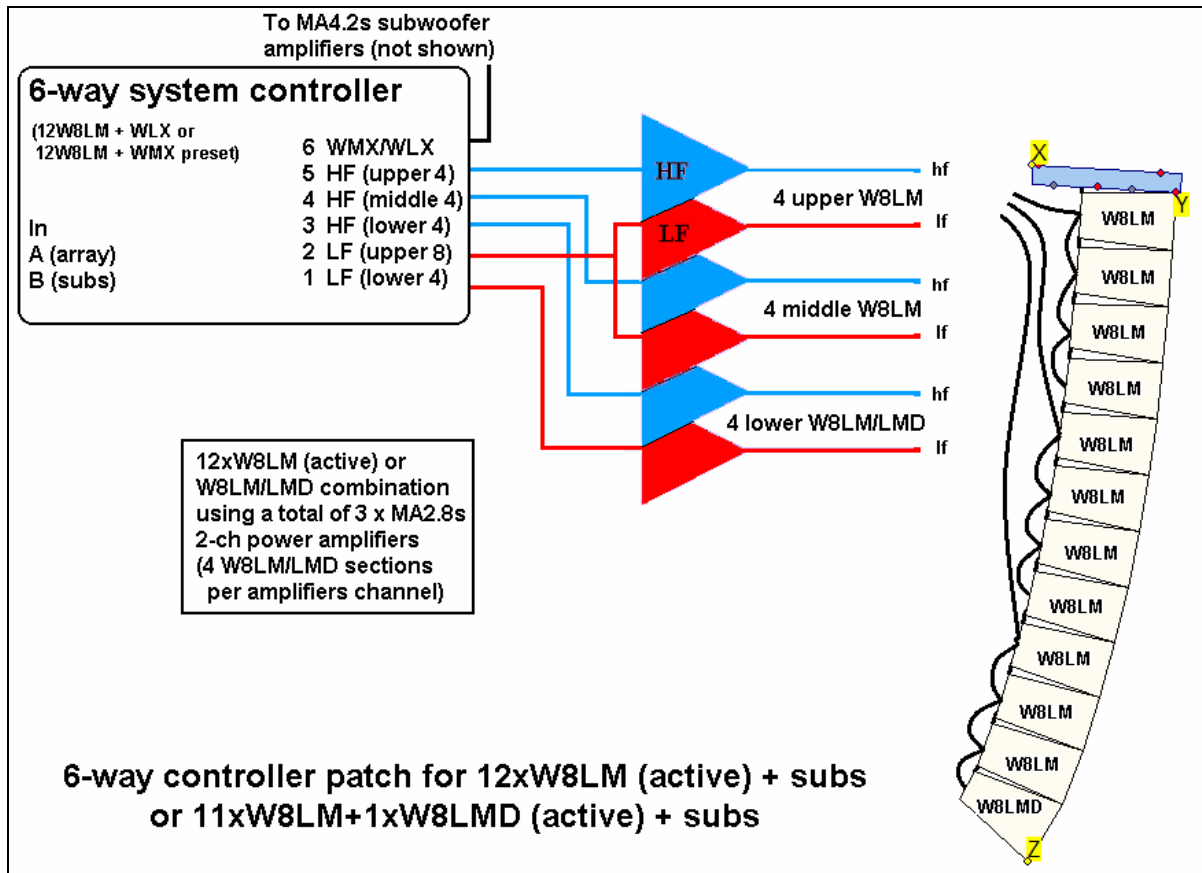

Rack patch examples – 16 x W8LM/LMD arrays

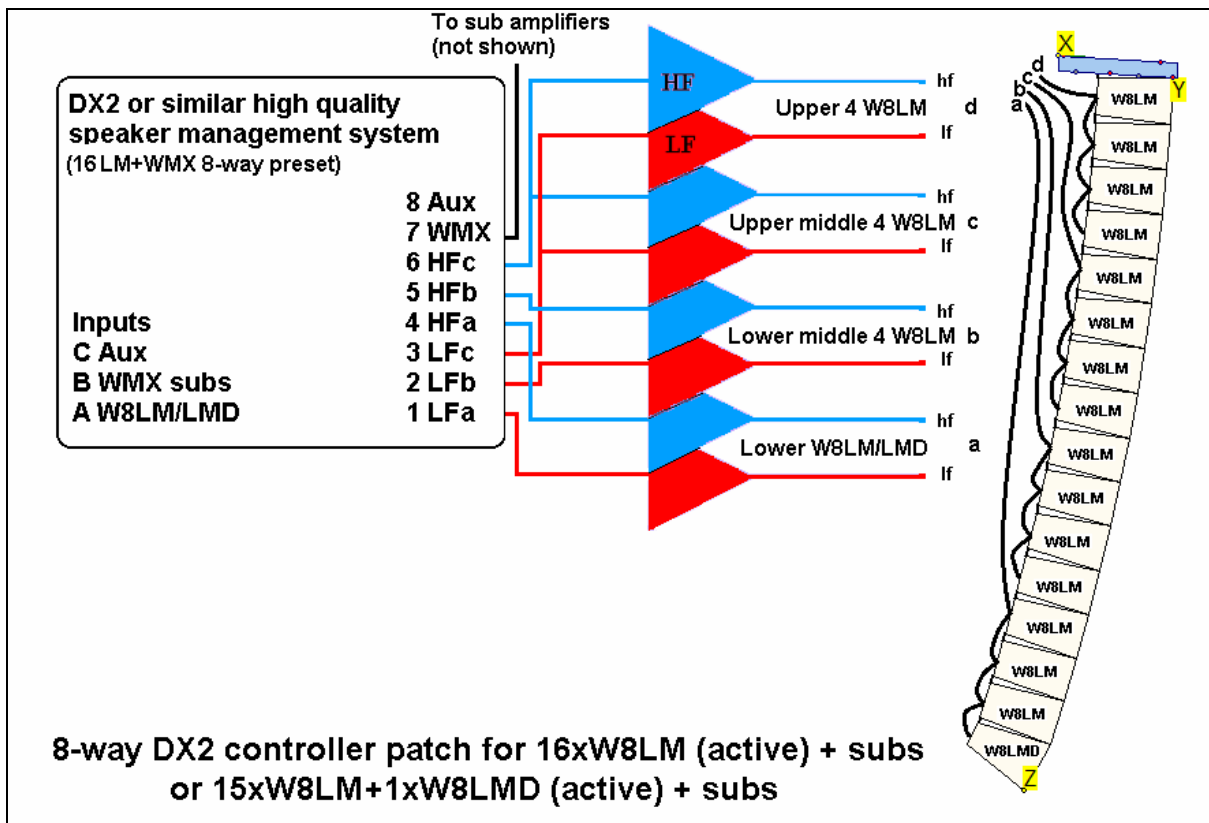
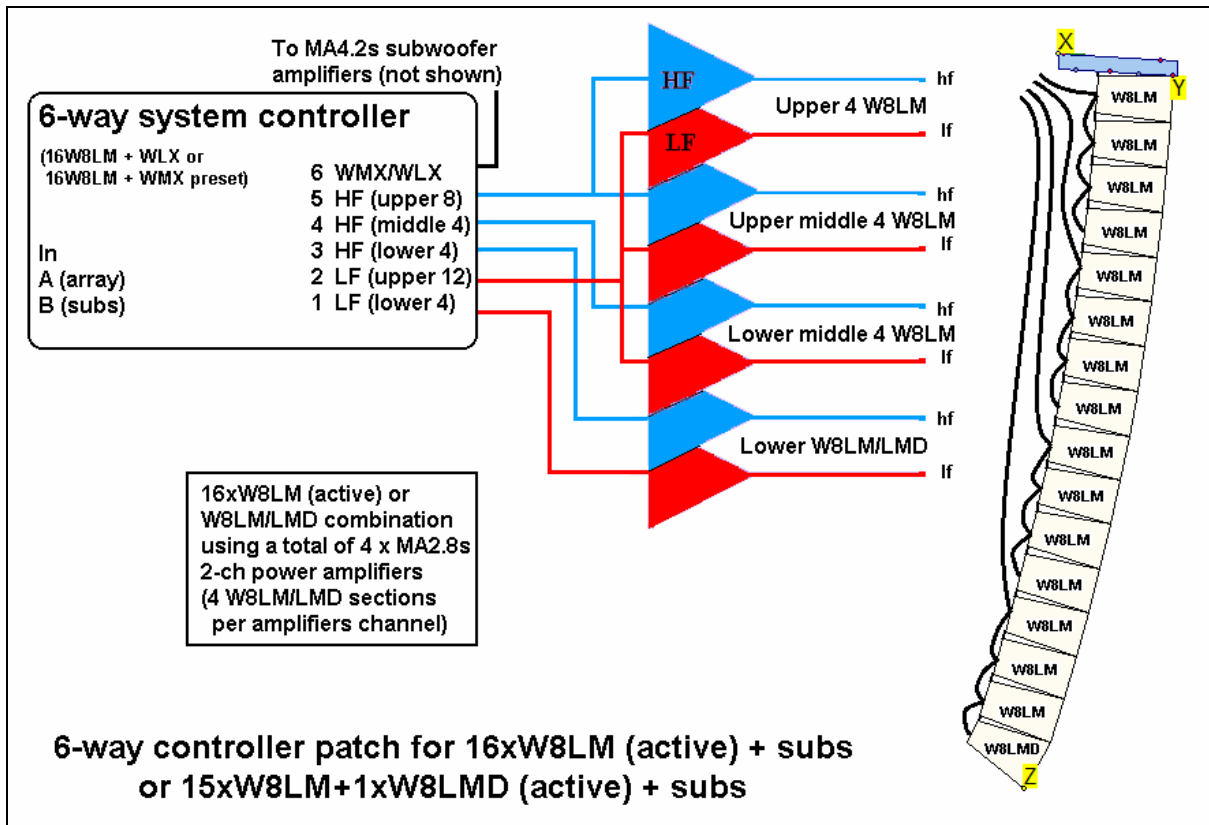

W8LM Pin-outs and cabling

Very Important Note about using MA2.8S power amplifiers with W8LM/LMDs

MA2.8S amplifier output A carries both channels via an NL4 connector as follows:

Pins +1/-1 = Ch1

Pins +2/-2 = Ch2



This dual output/single connector scheme may be used to drive one group of bi-amplified W8LM from one 2-ch power amplifier - via an NL4 cable directly from MA2.8S o/p A to the W8LMs. Please make sure that you use Channel A for LF and Channel B for HF.

For all passive applications we recommend using an NL2 connector from each power amplifier output to each group of W8LM to avoid mismatching.

W8LM/LMD		
Connector	Function	W8LM/LMD
		Active Passive
NL4		
+1	Low-mid +	Full-range +
-1	Low-mid -	Full-range -
+2	High +	
-2	High -	

Please note!

If you get no hf on an Active W8LM/LMD system check that:

-  All cabinets are switched to Active
-  You have selected an Active controller preset
-  All four NL4 cable cores are connected!

If you get no hf on a Passive W8LM/LMD system check that:

-  All cabinets are switched to Passive
-  You have selected a Passive controller preset

Connectors should be kept in good, clean condition to ensure full, undistorted loudspeaker performance. Worn, corroded or damaged pins and sockets can cause severe distortion or loss of signal.

Recommended loudspeaker cable

4-core cable is required for W8LM/LMDs.

The following table gives suitable copper core specifications for common applications:

**Cable run vs
copper core cross sectional area**



**Two W8LM/LMD's
paralleled at the array**

Up to 12m: 1.25mm²
Up to 25m: 2.5mm²

Up to 50m: 6mm²
(or 2 x 2.5mm² cores
in parallel using
splitters both ends)

**Four W8LM/LMDs
paralleled at the array**

Up to 12m: 2.5mm²
Up to 25m: 6mm²
(or 2 x 2.5mm² cores
in parallel using
splitters at both ends)

Up to 50m: Not recommended

Q. Why the odd sizes?

A. Loudspeaker cables are available in a limited range of standard copper core sizes
ie. 1.5mm², 2.5mm², 4mm², 6mm², 10mm² and 35mm².