

Wavefront Compact Series

Applications Guide



The Martin Experience

All material © 2007. Martin Audio Ltd. Subject to change without notice.

Wavefront Compact Series Applications Guide

Contents

<u>Introduction</u>	Wavefront Compact Series Overview
<u>Section 1</u>	W8C 3-way System
<u>Section 2</u>	W8CT & W8CM Line Array System
<u>Section 3</u>	W8CS Flown Subwoofer
<u>Section 4</u>	WSX Folded Horn Subwoofer
<u>Section 5</u>	W8L Series Line Array Systems

Appendix

<u>A1</u>	W8 3-way System
<u>A2</u>	W8S Hybrid™ Subwoofer

Introduction

Wavefront Compact Series Overview

Thank you for purchasing a Martin Audio Wavefront Compact Series system.

Wavefront Compact Series products make up a coherent "toolkit" of compact, live sound enclosures covering a huge range of professional sound projects from high quality club installations to major touring and festival systems.

Unpacking

Each Martin Audio loudspeaker is built to the highest standard and thoroughly inspected before it leaves the factory. After unpacking the system, examine it carefully for any signs of transit damage and inform your dealer if any such damage is found. It is suggested that you retain the original packaging so that the system can be repacked at a future date if necessary.

Please note that Martin Audio and its distributors cannot accept any responsibility for damage to any returned product through the use of non-approved packaging.

Standards

Martin Audio Wavefront Compact Series products conform to the requirements of the EMC Directive 89/336/EEC, amended by 92/31/EEC and 93/68/EEC and the requirements of the Low Voltage Directive 73/23/EEC, amended by 93/68/EEC.

EMC Standards Applied:

Emission EN55103-1:1996

Immunity EN55103-2:1996

Electrical Safety EN60065:1993

About this Applications Guide

This Applications Guide is based on Wavefront Compact field experience and general acoustical principles. We have provided information on the most popular system configurations and have included simple equations for those wishing to calculate the broadband coverage of their own cluster designs.

Going Further

Martin Audio Ltd manufactures a wide range of loudspeakers, system controllers and power amplifier. Visit our web-site at www.martin-audio.com for the latest product and applications news.

Cost effective rental

The Martin Audio Wavefront Compact Series "tool kit" approach provides all the components required to assemble high quality, truck-friendly, quick deployment sound systems for applications ranging from small clubs, commercial and theatrical productions using floor placed W8Cs and W8CS'...

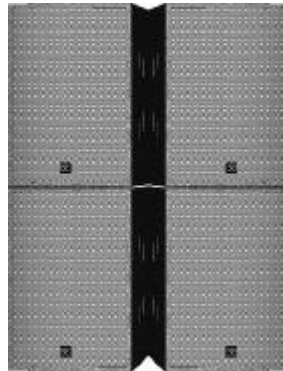

to vast outdoor events with flown Longthrow and W8C clusters:

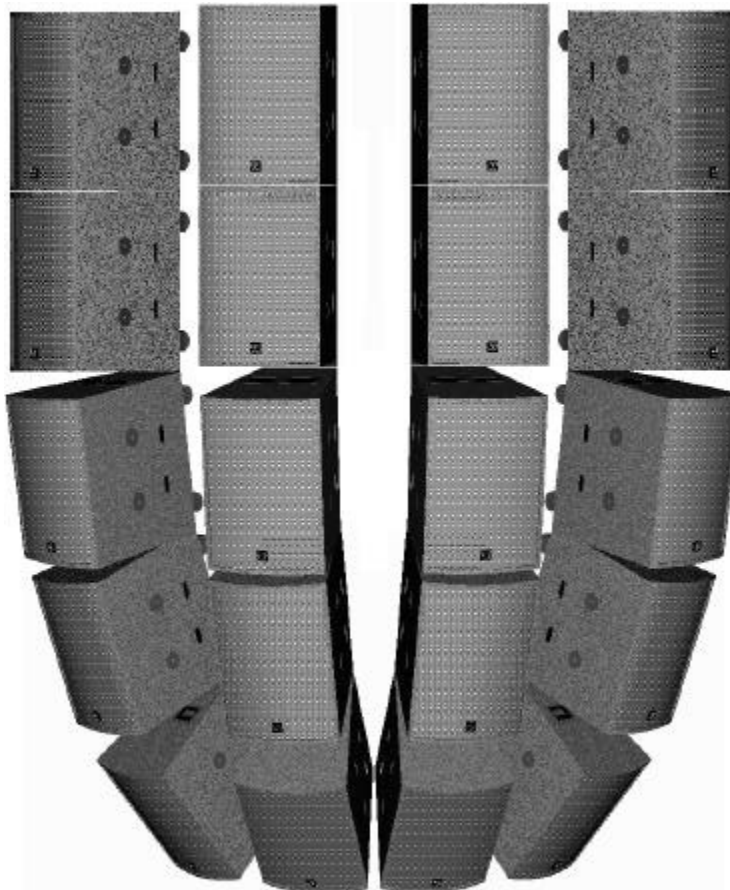

Wavefront W8C systems are regularly used for audiences ranging from just a few hundred jazz devotees to thousands of arena concert-goers. Longthrow sections can increase touring system versatility even further and Longthrow/W8C combinations have been very successfully used to cater for festival audiences from hundreds of thousands to over two million at “Popstock” 2000.

The Wavefront Compact series includes both flown and floor-standing subwoofers. W8CS’ may be flown where floor space is limited by extensive set designs or TV camera tracks. Where floor space is available, Wavefront WSX folded horn subwoofers may be used to implement an all-horn sound system for maximum efficiency and projection.

Wavefront Compact system versatility satisfies rental companies' requirements to maximise stock utilisation without compromising performance and reliability.

Wavefront W8C 3-way System



The heart of the Wavefront Compact series is the award-winning W8C ([Section 1](#)), a compact, light weight, high performance, 3-way loudspeaker system that has been engineered to work as well in small, stand-alone set-ups as it does in large flown arrays.

A single Wavefront W8C cabinet will cover 55° horizontally x 30° vertically. The W8C polar response is well defined so that it may be arrayed for high power rock and dance applications in large venues. A smooth off-axis amplitude and phase response allows a wide range of intercabinet angles to be used for easy coverage tailoring.

All Wavefront Compact series cabinets are fitted with MAN load-certified flying points to minimise set-up time. These MAN fittings are designed to comply with the 12:1 safety factor specified by the German VBG70 standard when used with compatible MAN flying systems.

Wavefront Longthrow W8CT & W8CM Line Array System



The Wavefront Longthrow W8CT & W8CM system ([Section 2](#)) is a compact, very powerful, light weight, multiple horn line array loudspeaker system whose cabinets have the same footprint and flying points as Wavefront W8C and W8CS systems.

Unlike odd-ball line arrays from other manufacturers, W8CTs and W8CMs have been designed to integrate seamlessly into the rest of the Wavefront family. The W8CM/CT combination may be rigged in continuous columns for high power, very long throw applications or may be used to complement regular W8C clusters by providing spot coverage for difficult seating areas.

The W8CT combines three horn-loaded high-mid drivers with six horn-loaded high frequency compression drivers. Like the award-winning W8C high-mid system, W8CT high-mid cone systems are optimally loaded to produce much lower distortion than typical waveguide-loaded compression drivers.

The W8CM has two vertically arrayed, low-mid horns to complement W8CT high-mid/high systems with seamless amplitude and polar integration.

Like all Wavefront series trapezoidal products, W8CTs and W8CMs are fitted with MAN load-certified flying points and are designed to comply with the 12:1 safety factor specified by the German VBG70 standard.

Wavefront W8CS Flown Subwoofer



The W8CS ([Section 3](#)) is a compact, light weight subwoofer that has the same cabinet footprint and flying points as the Wavefront W8C. It has been engineered to extend the W8C's performance to below 45Hz.

The W8CS comprises a special high excursion driver coupled to an efficient mid-bass horn and sub-bass port. This unique combination gives the W8CS the characteristic punch of a horn-loaded system with the low frequency bass extension of a reflex enclosure.

W8CS' may be used as full bass subwoofers (up to 120Hz) or may be flown as mid-bass sections (60-160Hz) to complement floor standing WSXs.

Wavefront WSX Folded Horn Subwoofer



The WSX folded horn subwoofer ([Section 4](#)) complements Wavefront Compact W8C touring systems to provide deep bass with maximum efficiency, speed and impact. It has a classic Martin 'S' shaped folded horn and couples a powerful, high excursion driver to the airload with a modified hyperbolic expansion law.

WSXs may be used as full bass subwoofers (up to 120Hz) or as low-bass headroom extenders to complement flown W8CS sections configured for mid-bass.

DX1 Loudspeaker Management System



The Martin Audio DX1 ([Section 1.5](#)) is a very high performance, 2 input/ 6 output DSP-based controller providing crossover, protection, delay and alignment functions. It comes with factory plug'n'play presets for a wide range of Martin Audio product configurations including the Wavefront Compact family. It is ideal for combining Wavefront Compact products into seamless systems.

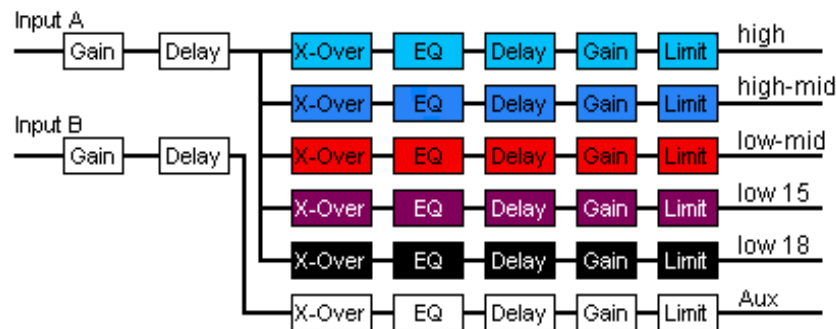

For instance, two DX1s may be used to combine W8Cs, W8CS' and WSXs to form a stereo, 5-way, active, all horn system for the ultimate performance and impact. One more DX1 may be used to add W8CT and W8CM Longthrow sections for difficult venues or large outdoor events.

Wavefront Compact Series

Applications Guide

Section 1

Wavefront W8C 3-Way System



The Martin Experience

All material © 2007. Martin Audio Ltd. Subject to change without notice.

Section 1

Wavefront W8C 3-Way System

Contents

- [1.1](#) **Introduction**
- [1.2](#) **Specifications**
- [1.3](#) **Pin-outs and cabling**
- [1.4](#) **System patching**
- [1.5](#) **DX1 Loudspeaker Management System**
- [1.6](#) **Power amplifier recommendations**
- [1.6.1](#) **Martin Audio MA2.8 Power Amplifier Overview**
- [1.7](#) **General operational summary**
- [1.8](#) **Arraying and placement**
- [1.9](#) **Coverage calculations**
- [1.10](#) **W8Cs as front fills**
- [1.11](#) **W8Cs as side clusters**
- [1.12](#) **W8Cs in distributed (delay) systems**

Wavefront W8C 3-Way System



1.1 Introduction

The award-winning Wavefront W8C 3-Way System is a very compact, light weight, high performance 3-way loudspeaker system in a trapezoidal cabinet. The Wavefront W8C integrates a horn-loaded 12" low-mid driver with a horn-loaded 6.5" high-mid driver and a horn-loaded 1" very high frequency compression driver. The 6.5" high-mid cone driver provides a whole order better performance than a large compression driver and is optimally loaded using a toroidal phase plug.

Wavefront series trapezoidal cabinets are fitted with MAN load-certified flying points and are designed to comply with the 12:1 safety factor specified by the German VBG70 standard when used with compatible 12:1 flying systems. One important advantage of the MAN flying system is that inter-cabinet connections place a minimal load on the cabinets and, being external, can be load certified and inspected independently.

1.2 Specifications

Type:	3-way trapezoid, switchable active/passive high-mid/high via rear panel switch (see Section 1.5)
Frequency response:	120Hz - 18kHz +/- 3dB
LF limit:	-10dB @ 100Hz
Drivers:	1 x 12" (305mm) low-mid horn 1 x 6.5" (165mm) high-mid horn 1 x 1" (25mm) exit hf compression driver
Rated power:	Low-mid 300W AES, 1200Wpk High-mid (active/passive) 150W AES, 600Wpk High (active) 60W AES, 240Wpk
Sensitivity:	Low-mid 106dB/W High-mid 108dB/W High 107dB/W

Maximum SPL:	129dB continuous, 135dB peak
Impedance:	Low-mid 8 ohms nominal High-mid 16 ohms nominal High 16 ohms nominal
Coverage (-6dB):	55° horizontal, 30° vertical
Crossover:	750Hz, 3.5kHz
Connectors:	2 x Neutrik NL8, 2 x EP8
Cabinet construction:	Birch Ply
Cabinet finish:	Slate textured paint
Protective grille:	Perforated steel
Grille finish:	Grey paint
Dimensions (incl wheels):	(W) 562mm x (H) 799mm x (D) 925mm (W) 22.1ins x (H) 31.5ins x (D) 36.4ins
Flown weight:	69kg (152lbs). Lid 4kg (9lb) extra

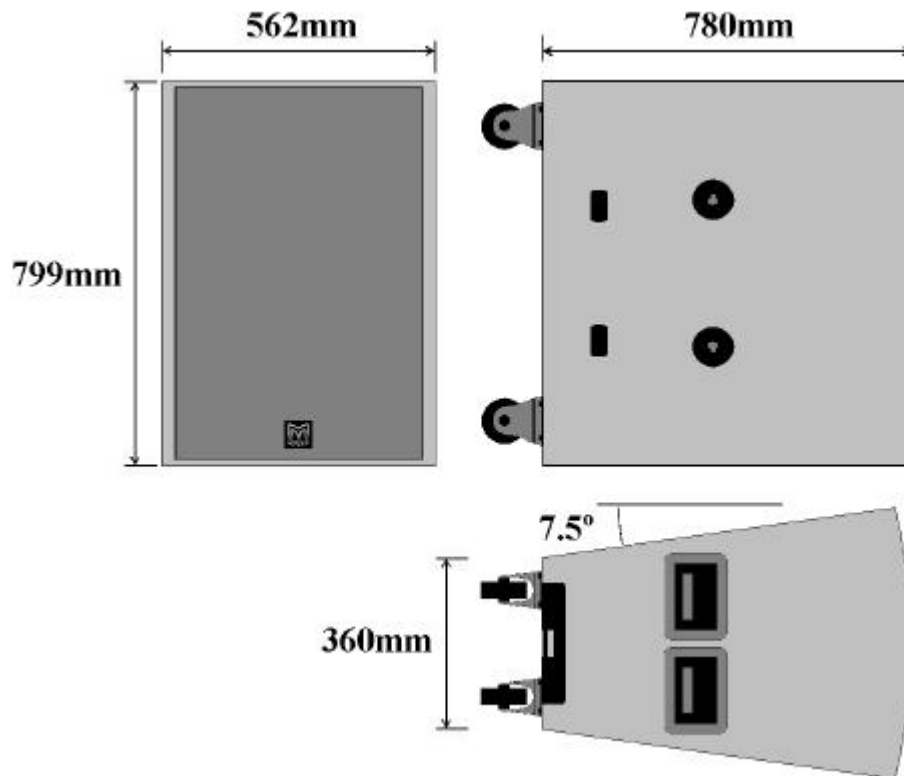

Before rigging, note colour coding!

**W8C has 2 black points per side
W8CS has 1 black point per side**

**W8CT has 2 orange points per side
W8CM has 1 orange point per side**

1.3 Pin-outs and cabling

W8C

Connector type		W8C mode	
EP8	NL8	W8C Active*	W8C Passive*
1	-1	Low Mid -	Low Mid -
2	+1	Low Mid +	Low Mid +
3	-2	High Mid -	High Mid/High -
4	+2	High Mid +	High Mid/High +
5	-3	High -	n/c
6	+3	High +	n/c
7	-4	n/c	n/c
8	+4	n/c	n/c

(*see [Section 1.5](#) for details of the connector panel Active/Passive switch)

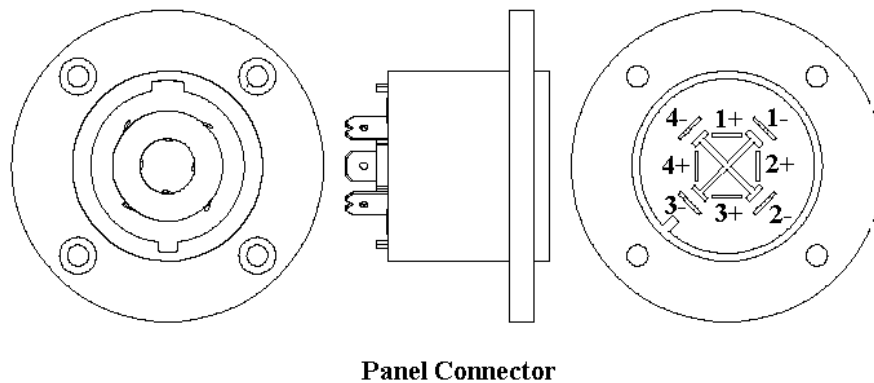
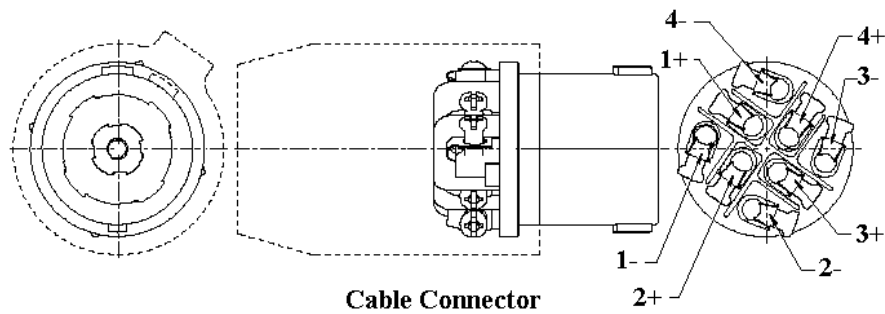

1.3.1 Cable and panel connector part numbers

Please note the following part numbers when ordering loudspeaker connectors to make up cables and patch panels

Neutrik NL connectors

NL8FC	8 pole cable (female)
NL8MPR	8 pole panel (male)
NL8MM	8 pole inline coupler (male-male)

Cannon EP connectors

EP8-11	8 pin cable female
EP8-12	8 pin cable male
EP8-13	8 pin panel mount female
EP8-14	8 pin panel mount male

Connectors should be kept in good, clean, uncorroded condition to ensure full, undistorted loudspeaker performance. Corroded or damaged pins and sockets can cause severe distortion or loss of signal.

1.3.2 Recommended loudspeaker cable

Cable run vs copper core cross sectional area



	Single W8C	Two W8C paralleled at the cluster.
Up to 50m	2.5mm ²	6mm ² (or 2 x 2.5mm ² cores in parallel)
Up to 100m	6mm ²	10mm ² (or 2 x 6mm ² cores in parallel)

Q. Why the odd sizes?

A. Loudspeaker cables are available in a limited range of standard copper core sizes - ie. 1.5mm², 2.5mm², 4mm², 6mm², 10mm² and 35mm².

1.4 System patching

A good system patch should...

- 1) Be electrically safe - ie be put together by suitably qualified electrical technicians paying attention to possible sources of moisture, connector damage, cable damage, user and public safety.
- 2) Enable the system to provide the required sound quality, coverage and level

without feedback and without stressing its mechanical, electrical or electro-acoustic components.

- 3) Be divided into easily understood sections (eg Main, midfield, downfill etc) and clearly labelled so that adjustments may be made quickly and efficiently.

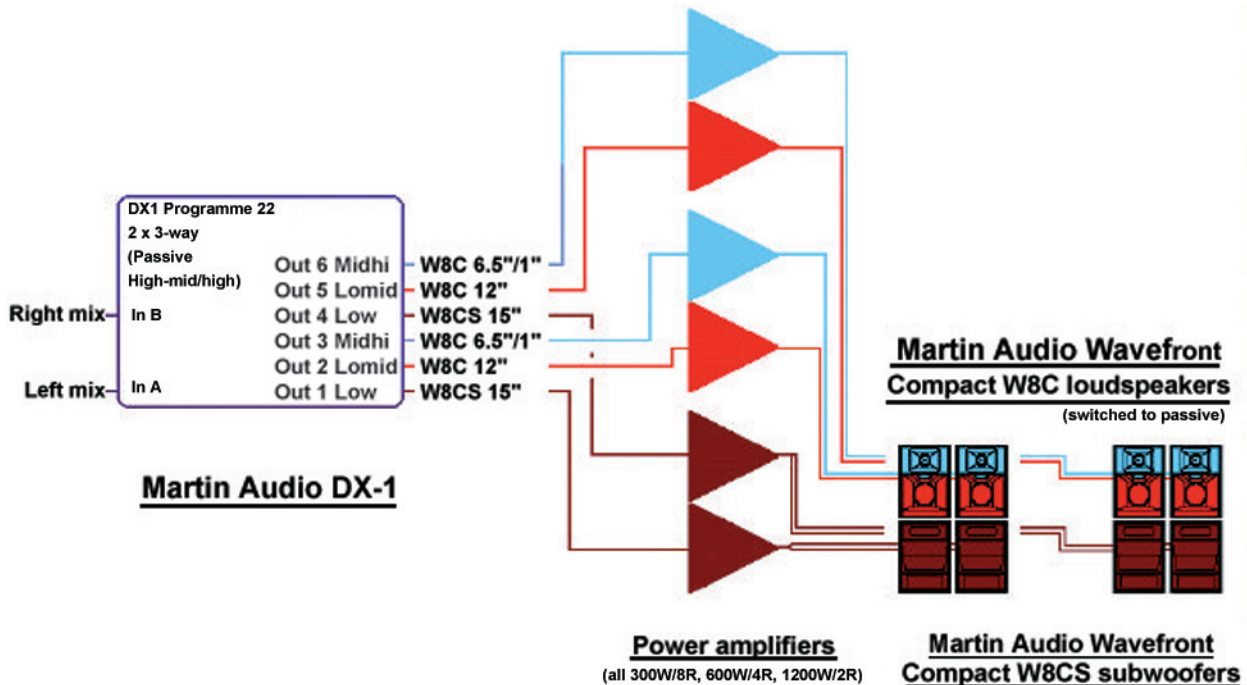

The schematic above shows a simple system using a Martin Audio DX1 Loudspeaker Management System configured as a 2 x 3way crossover controlling W8Cs switched for passive high-mid/high sections and W8CS subwoofers.

See the [Section 1.5](#) for further DX1 information and [Section 2](#) of this applications guide for a more complex example.

1.4.1 Cluster sub-sections

When designing a large sound system it is worth spending a little time working out a sensible cluster patch to optimise audience coverage.

The following example is a 4 wide, 4 deep W8C classical music centre cluster divided into farfield, midfield, nearfield and downfill horizontal rows and inner and outer vertical columns. The active (3-way) W8Cs may be patched in pairs for symmetrical control.

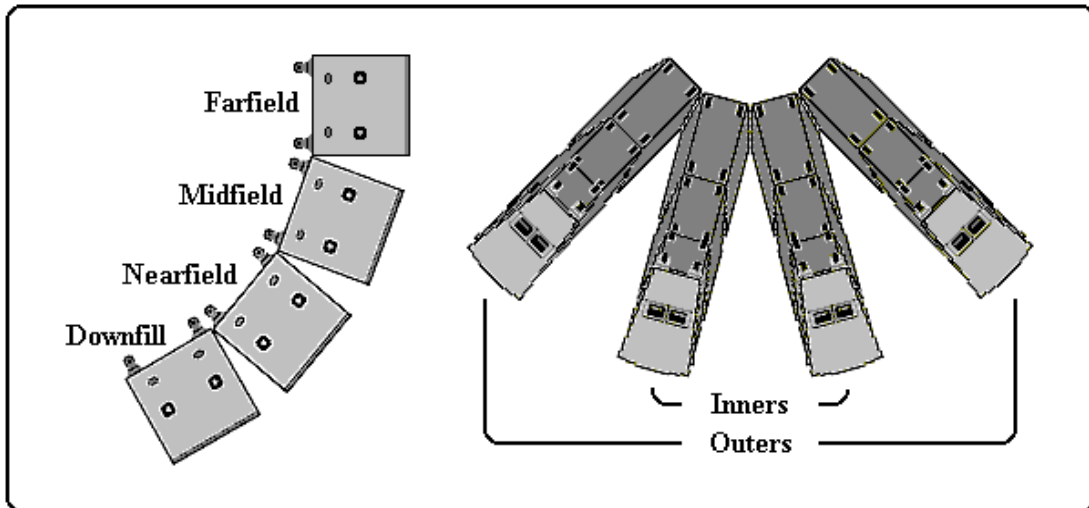

Recommended W8C pairs:

Inner Farfield	Outer Farfield
Inner Midfield	Outer Midfield
Inner Nearfield	Outer Nearfield
Inner Downfill	Outer Downfill

Controller channel allocations

The whole cluster may be controlled from just ½ a Martin Audio DX1 controller set up for 3-way operation. See [Section 1.5](#) for further DX1 information.

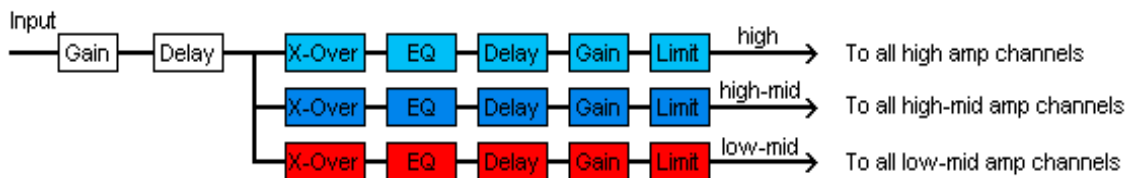

Power amplifier channel allocations

There are 8 pairs of W8Cs each requiring high, high-mid & low-mid power amplifier channels.

8 pairs at 3 bands per pair = 24 amplifier channels required
 = 12 x 2ch amplifiers per cluster.

2ch power amplifier allocations:

Farfield inner & outer high	Farfield inner & outer himid	Farfield inner & outer lomid
Midfield inner & outer high	Midfield inner & outer himid	Midfield inner & outer lomid
Nearfield inner & outer high	Nearfield inner & outer himid	Nearfield inner & outer lomid
Downfill inner & outer high	Downfill inner & outer himid	Downfill inner & outer lomid

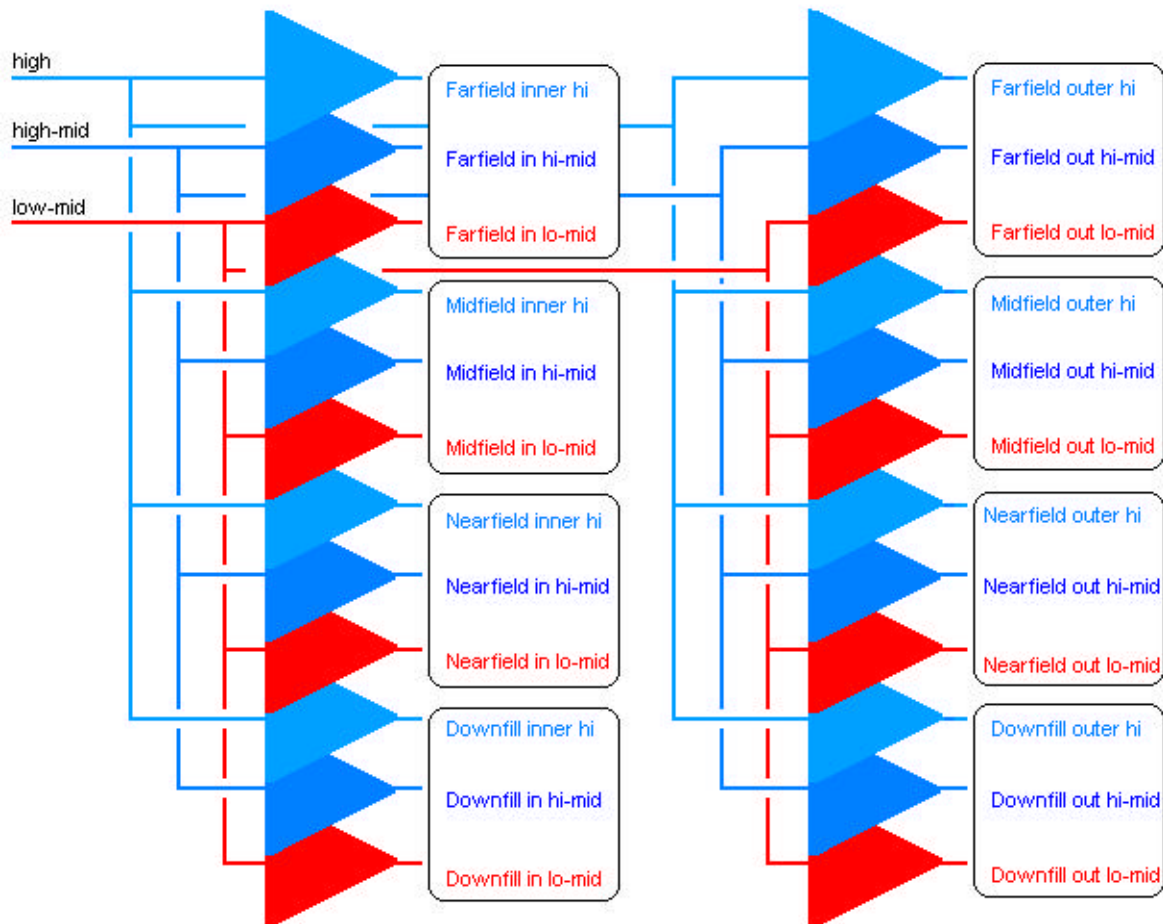

Initial inner level settings

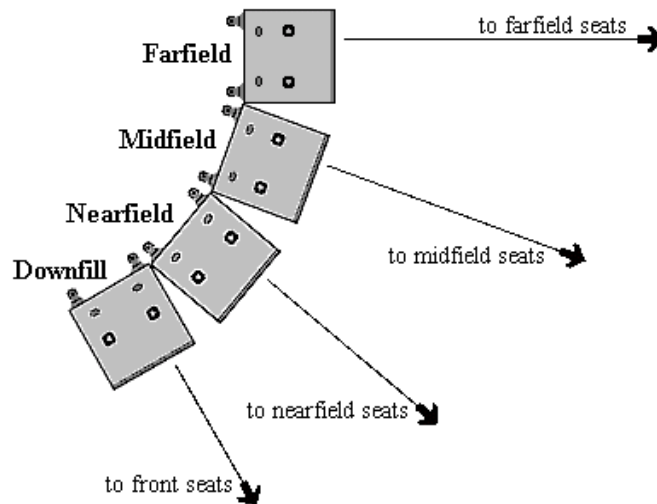

Initial inner level settings can be calculated for each row as follows:

The farfield inner power amplifier channels are the reference...

Assuming that the farfield inner amp channels = 0dB (fully cw),
Inner amplifier gain control setting calculations are:

Midfield inner amp channels	=	$20 \times \log^{10} \frac{\text{midfield inner distance}}{\text{farfield inner distance}}$
Nearfield inner amp channels	=	$20 \times \log^{10} \frac{\text{nearfield inner distance}}{\text{farfield inner distance}}$
Downfill inner amp channels	=	$20 \times \log^{10} \frac{\text{downfill inner distance}}{\text{farfield inner distance}}$

Initial outer level settings

Similarly, initial outer level settings can be calculated for each row as follows:

Again, the farfield inner amplifier setting (0dB) is used as a reference...

Assuming that the farfield inner amp channels = 0dB (fully cw),
Outer amplifier gain control setting calculations are:

Farfield outer amp channels	=	$20 \times \log^{10} \frac{\text{farfield outer distance}}{\text{farfield inner distance}}$
Midfield outer amp channels	=	$20 \times \log^{10} \frac{\text{midfield outer distance}}{\text{farfield inner distance}}$
Nearfield outer amp channels	=	$20 \times \log^{10} \frac{\text{nearfield outer distance}}{\text{farfield inner distance}}$
Downfill outer amp channels	=	$20 \times \log^{10} \frac{\text{downfill outer distance}}{\text{farfield inner distance}}$

In a fairly small, wide, fan-shaped venue with heavily raked seating, we may require the following amplifier channel settings:

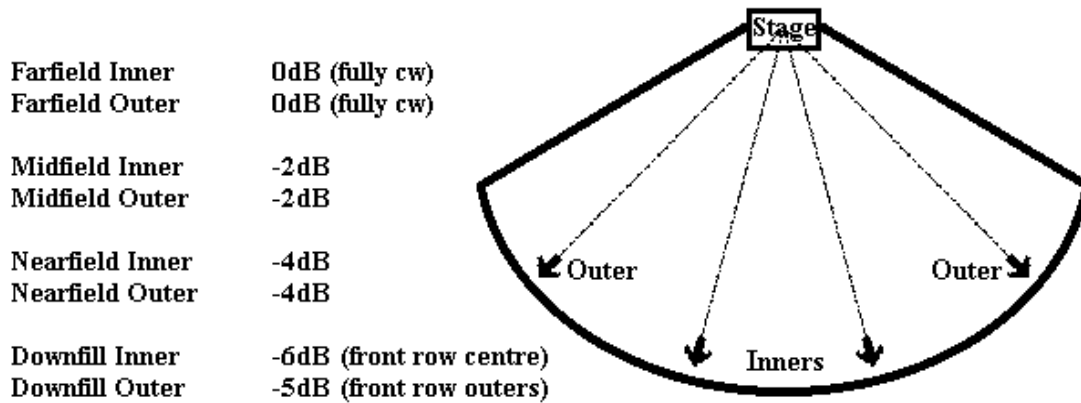

The attenuation rate shown here is 2dB per cluster row. The actual rate of vertical attenuation will depend on the cluster height which in turn will depend on the rake of the seats. High clusters are further from the audience at the front and require less nearfield & downfill attenuation. The lower the cluster, the greater the required attenuation rate.

Again, the vertical layout is...

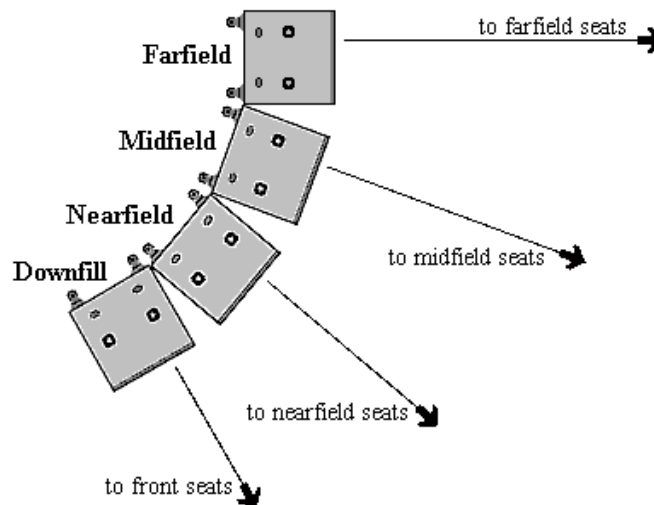

In a narrower venue, we may require the outer sections to be attenuated a little, particularly in the farfield section, as follows:

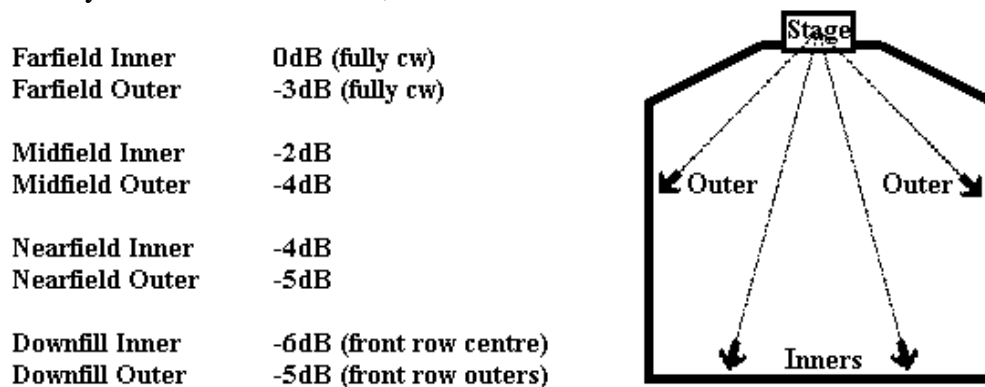

1.5 DX1 Loudspeaker Management System



Martin Audio can provide factory set configuration cards for a variety of off-the-shelf crossover systems (contact your dealer or Martin Audio Ltd for further information) but the Martin Audio DX1 Loudspeaker Management System is strongly recommended for all new Wavefront system designs.

The Martin Audio DX1 is a very high performance DSP-based controller and provides crossover, protection, delay and alignment functions. As a Martin Audio product, the DX1 is kept up-to-date with preset crossover and limiter functions suitable for a wide range of system configurations and power amplifiers.

Preset Number	Loudspeaker system	Config.	Input A	Input B	Output 1	Output 2	Output 3	Output 4	Output 5	Output 6
20	WSX + W8C 3-way Passive	2x3 way	o/p 1 to 3	o/p 4 to 6	WSX Low	W8C Lomid	W8C Himid/Hi	WSX Low	W8C Lomid	W8C Himid/Hi
21	WSX + W8C 4-way Active	1x4 way	o/p 1 to 4	o/p 5 to 6	WSX Low	W8C Lomid	W8C Himid	W8C High	Aux	Aux
22	W8CS + W8C 3-way Passive	2x3 way	o/p 1 to 3	o/p 4 to 6	W8CS Low	W8C Lomid	W8C Himid/Hi	W8CS Low	W8C Lomid	W8C Himid/Hi
23	W8CS + W8C 4-way Active	1x4 way	o/p 1 to 4	o/p 5 to 6	W8CS Low	W8C Lomid	W8C Himid	W8C High	Aux	Aux
25	WSX + W8C with HF Lift	1x4 way	o/p 1 to 4	o/p 5 to 6	WSX Low	W8C Lomid	W8C Himid	W8C High	Aux	Aux
26	WSX + W8CT/CM Long Throw	1x4 way	o/p 1 to 4	o/p 5 to 6	WSX Low	W8CM Lomid	W8CT Himid	W8CT High	Aux	Aux

DX1 Factory Preset Examples

W8C Rear panel Active/Passive switch

Please note that the W8C rear connector panel is equipped with an Active/Passive switch.

Active mode (DX1 factory presets 21, 23 or 25)

In *Active* mode each driver (low-mid, high-mid & high) is driven by its own power amplifier channel. These power amplifier channels are sourced from the appropriate DX1 output to ensure optimal crossover and limiter alignment.

The advantages of active mode are:

- Smoother high-mid/high amplitude and phase response
- Smoother high-mid/high vertical polar response
- Improved high-mid/high amplifier headroom

- Improved high-mid/high limiter action

Three Martin Audio MA2.8 power amplifiers will drive four W8Cs (assuming W8Cs driven in pairs).

Passive Mode (DX1 factory presets 20 & 22)

In *Passive* mode the high-mid and high drivers share a power amplifier channel via a passive high-mid/high crossover network built into the loudspeaker cabinet. This mode offers a slightly reduced performance but requires only two power amplifier channels per 3-way W8C system.

Two MA2.8s will drive four W8Cs (assuming W8Cs driven in pairs).

The following shows the DX1 with programme 20 selected. This caters for a stereo set-up comprising left and right W8Cs in *Passive* mode plus separate left and right WSX subwoofers:

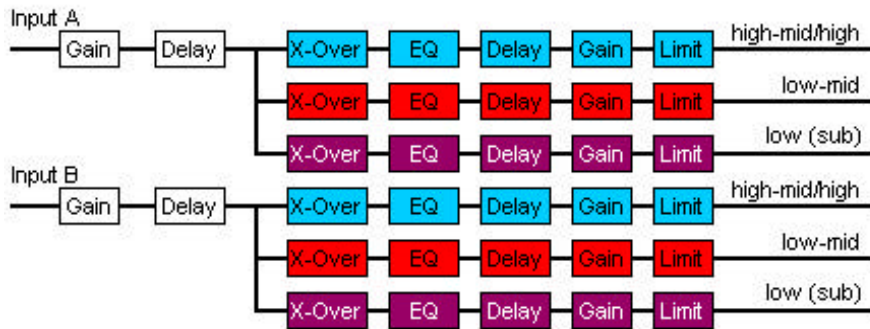

DX1 factory preset 20 (2 x 3 way configuration)
Stereo WSX+W8C (passive high-mid/high) system

Custom DX1 set-ups

Experienced users may create custom DX1 set-ups, for example...

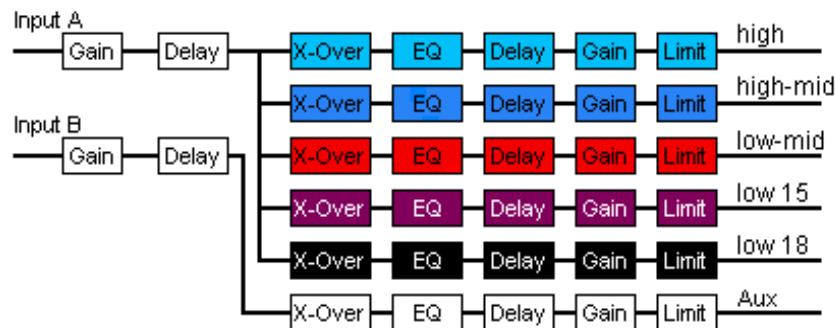

5 way configuration

e.g. W8C (active high-mid/high) system with flown W8Cs' (low 15) used as mid-bass bins augmented by stacked WSXs (low 18).

See [Section 2.4](#) for a full system example.

1.5.1 DX1 specifications

Inputs	2 electronically balanced. >10k ohms
CMRR	>65dB 50Hz - 10kHz
Outputs	6 electronically balanced. <60 ohms
Min. Load	600 ohm
Max. Level	+20dBm into 600 ohm load
Frequency Resp.	±0.5dB 20Hz - 20kHz
Dynamic Range	>110dB 20Hz -20kHz. Unwtd
Distortion	<0.02% @ 1kHz, +18dBm
Maximum Delay	650mS. (Increment 2.6uS)
Output gain	adjustable +15dB to -40dB in 0.1dB steps and mute
Input gain	adjustable +6dB to -40dB in 0.1dB steps

Parametric Equalisation

Filters	5 Sections per output
Filter gain	+15dB to -30dB in 0.1dB step
Centre frequency	0Hz - 20kHz, 1/36 octave steps (368 positions)
Filter Q / BW	0.4 to 128 / 2.5 to 0.008
(Sections switched to shelving response)	
Low frequency	20Hz - 1kHz
High frequency	1kHz - 20kHz
Shelf gains	±15dB in 0.1dB steps

Crossover (high-pass and low-pass) filters

Filters	1 of each per output
Frequency (HPF)	10Hz - 16kHz, 1/36 octave steps
Frequency (LPF)	60Hz - 22kHz, 1/36 octave steps
Response	Bessel / Butterworth 12/18/24dB per octave Linkwitz-Riley 24dB per octave

Limiters

Threshold	+22dBu to -10dBu
Attack time	0.3 to 90 milliseconds
Release time	4, 8, 16 or 32 times the attack time

Power required	60 to 250V ±15% @ 50/60Hz. < 20 watts
Weight	3.5kg Net (4.8kg Shipping)
Size	44 (1U) x 482 x 300mm excluding connectors

1.5.2 DX1 Output Gain and Limiter settings for W8Cs

Standardising on one good model of power amplifier (preferably the [Martin Audio MA2.8](#)) and correctly set-up controller (preferably the [Martin Audio DX1](#)) will provide the most dynamic system performance and protection whilst simplifying design and reducing spares inventories.

Gain settings

The following DX1 output gain settings will enable full system performance to be obtained whilst keeping the console and drive system noise floors inaudible and avoiding amplifier slew-rate limiting:

W8C - assuming 300Wcont - 600Wpk into 8Ω power amplifiers:						
Best-fit Amplifier Example	Amplifier Sensitivity		Amplifier Gain dB	Initial DX1 Output <u>GAIN</u>		
	dBu	Vrms		Lomid	Himid	High
	dB	dB	dB	dB	dB	dB
Martin MA2.8* (38dB)	-2	0.62	38	-9	-9	-7
Crest CA9 (x68)	-1	0.69	37	-8	-8	-6
Crown MA1202 (0.775v)	0	0.77	36	-7	-7	-5
	+1	0.87	35	-6	-6	-4
QSC PL224	+2	0.98	34	-5	-5	-3
	+3	1.09	33	-4	-4	-2
Martin MA2.8* (32dB)	+4	1.23	32	-3	-3	-1
Crest 4801 (x40)	+4	1.23	32	-3	-3	-1
Crown K1 (1.4v)	+4	1.23	32	-3	-3	-1
QSC PL218/218A (32dB)	+4	1.23	32	-3	-3	-1
QSC PL224A (32dB)	+4	1.23	32	-3	-3	-1
Crown MA1202 (1.4v)	+5	1.38	31	-2	-2	0
	+6	1.55	30	-1	-1	+1
	+7	1.73	29	0	0	+2
	+8	1.95	28	+1	+1	+3
	+9	2.18	27	+2	+2	+4
Crown MA1202 (26dB)	+10	2.45	26	+3	+3	+5
Crown K1 (26dB)	+10	2.45	26	+3	+3	+5
QSC PL218A (26dB)	+10	2.45	26	+3	+3	+5
QSC PL224A (26dB)	+10	2.45	26	+3	+3	+5

* Set Martin Audio MA2.8 rear MLS switch to -2dB to match peak output of unregulated power amplifiers.

Cluster balance (eg farfield-to-nearfield or inner-to-outer) should be adjusted **at the power amplifier controls** to maintain limiter tracking. See [Section 1.7](#).

Balancing the system using gain controls in the signal path *before* the power amplifiers will cause the higher signal level upper row of a big cluster to start limiting before the lower signal levels downfills causing tonal changes at the mix position.

Limiter settings

The Rated Power specifications in [Section 1.2](#) show that the maximum allowable power dissipation depends on the driver/s being driven. This is because big low and low-mid drivers are capable of dissipating more heat than smaller high-mid and high drivers.

Normal music and speech signals, however, are a combination of relatively low general power levels with a multiplicity of short term transients. These short term transients do not significantly heat the driver voice coils so it is quite permissible to use the same 250-300W into 8Ω (500-600W into 4Ω) power amplifiers for all sections of the W8C, W8CT and W8CM [as long as they are sourced by a correctly set controller.](#)

When choosing power amplifiers, do not be tempted to exceed the 250-300W into 8Ω (500-600W into 4Ω) power rating unless the amplifier's power rails are well regulated (see [Section 1.6](#)) - even with properly set controllers in place.

Although Martin Audio drivers are mechanically designed to survive normal road use and the occasional operator error, over-powered or bridged amplifiers can cause over-excursions that stress and age drivers. The best way to get the clean, relaxed sound of an overpowered amplifier is to choose an amplifier with plenty of current reserve - ie an amplifier with good 2Ω specification - and avoid running more than two cabinets in parallel.

To ensure transparent limiter operation without obvious distortion or pumping, the DX1 limiter attack and release times are factory preset to be inversely proportional to each band's high pass frequency as follows:

High pass filter range	Attack time	Release time
>31Hz	45mS	720mS
31Hz - 63Hz	16mS	256mS
63Hz - 125Hz	8mS	128mS
125Hz - 250Hz	4mS	64mS
250Hz - 500Hz	2mS	32mS
500Hz - 1KHz	1mS	16mS
1KHz - 2KHz	0.5mS	8mS
2KHz - 22KHz	0.3mS	4mS

These attack times will allow the power amplifiers to clip momentarily but not for

long enough to be obvious to listeners or cause driver overheating. It is quite normal to see amplifier clip indicators on the odd programme peak but continuous clipping would indicate a cable short circuit, wrong controller settings, excessive power amplifier gain or low mains voltage.

The following DX1 output limiter settings will avoid voice coil overheating and minimise amplifier clipping for high quality, trouble free operation.

W8C - assuming 300Wcont - 600Wpk into 8Ω power amplifiers:						
Best-fit Amplifier Example	Amplifier			Recommended DX1 <u>LIMITER</u>		
	Sensitivity dBu	Vrms	Gain dB	Lomid dBu	Himid dBu	High dBu
<u>Martin MA2.8* (38dB)</u>	-2	0.62	38	-3	-6	-9
Crest CA9 (x68)	-1	0.69	37	-2	-5	-8
Crown MA1202 (0.775v)	0	0.77	36	-1	-4	-7
QSC PL224	+1	0.87	35	0	-3	-6
	+2	0.98	34	+1	-2	-5
	+3	1.09	33	+2	-1	-4
<u>Martin MA2.8* (32dB)</u>	+4	1.23	32	+3	0	-3
Crest 4801 (x40)	+4	1.23	32	+3	0	-3
Crown K1 (1.4v)	+4	1.23	32	+3	0	-3
QSC PL218/218A (32dB)	+4	1.23	32	+3	0	-3
QSC PL224A (32dB)	+4	1.23	32	+3	0	-3
Crown MA1202 (1.4v)	+5	1.38	31	+4	+1	-2
	+6	1.55	30	+5	+2	-1
	+7	1.73	29	+6	+3	0
	+8	1.95	28	+7	+4	+1
	+9	2.18	27	+8	+5	+2
Crown MA1202 (26dB)	+10	2.45	26	+9	+6	+3
Crown K1 (26dB)	+10	2.45	26	+9	+6	+3
QSC PL218A (26dB)	+10	2.45	26	+9	+6	+3
QSC PL224A (26dB)	+10	2.45	26	+9	+6	+3

* Set Martin Audio MA2.8 rear MLS switch to -2dB to match peak output of unregulated power amplifiers.



Use lower limiter settings (or more loudspeakers!) if your power amplifiers indicate clipping on more than just the odd peak. Excessive clipping may also be caused by cable faults or an inadequate mains supply. See [Section 1.6](#)

The DX1 may be user-programmed to many more touring and fixed installation configurations based on its 2 input + sum, 6 output matrix. This operation is best completed by an audio technician who is familiar with DSP-based pro-audio.

(See separate [DX1 Speaker Management System Operating User's Guide](#) for details)

1.6 Power amplifier recommendations

Wavefront Compact Series loudspeaker systems have been designed and manufactured for very high performance and arrayability. The systems are very easy to use - particularly if power amplifier racks and controller settings are standardised within a system.

Power capability

W8Cs will provide full performance when driven by professional power amplifiers capable of delivering undistorted output power into a range of loads as follows:

W8C

250-300W(AES) into 8 ohms,
500-600W(AES) into 4 ohms
and
1,000-1,200W(AES) into 2 ohms.

Please note:

Amplifiers with inadequate headroom before clipping may age high frequency components due to excessive signal density.

Amplifiers with excessive output may damage voice-coils or age driver suspensions due to excessive heat dissipation and excursion.

A note about power amplifier output specifications

Most power amplifier manufacturers keep their costs down by using unregulated supply rails which sag under load. To allow for this sag, manufacturers set their rails high so that they still meet their quoted output into specified loads. These high rail voltages allow such power amplifiers to provide outputs 1.5 - 2 times their quoted power for short-term bursts. Martin Audio products will withstand this potential doubling of instantaneous power - [with suitably set controller limiters](#) - but further, long-term increases caused by oversized amplifiers should be avoided.

Martin Audio MA Series Power Amplifiers

Martin Audio MA Series amplifiers have regulated rails so it is quite permissible to use slightly overpowered models - with suitably set controller limiters - without risking uncontrolled power bursts. The MA series power amplifiers' regulated power rails also ensure maximum performance under the real-world concert conditions of less-than-optimum mains supplies and parallel cabinets. See [Section 1.6.1](#).

Most non-Martin power amplifiers' 4 ohm performance figures are specified assuming very well regulated bench supplies but fail to reach these specifications under touring conditions. These amplifiers can be a totally false economy as they cannot drive parallel cabinets without a very audible loss of headroom and quality.

Amplifier load tolerance

An efficient loudspeaker in live concert conditions can act as a surprisingly dynamic and complex load. Most modern touring power amplifiers claim 2 ohm capabilities but make sure your amplifier is also capable of driving reactive (ie inductive or capacitive) loads without prematurely clipping or developing output stage crossover distortion.

Mains safety!

A fully qualified technician should check mains safety and phase voltage *before* the system is patched.

Power reserve

Power amplifier specifications are usually based on bench measurements made using stable, high current mains supplies and well defined loads. Amplifiers sound best when they have plenty of current in reserve for musical peaks.

- 1) Try to ensure that the mains supply stays within the amplifier manufacturer's specified range from no load to maximum load. An electrical technician should check the mains supply vs demand using an accurate rms voltage meter.
- 2) If unfamiliar generators are being used the electrical technician should check the mains waveform (using a portable 'scope-meter) to make sure that it is sinusoidal and not crawling with spikes or interference.
- 3) Avoid driving too many W8Cs in parallel. I would suggest no more than two so that the amplifier's 2Ω spec is kept in reserve for musical peaks.
- 4) Avoid using power amplifiers in bridged mode. Most commercial power amplifiers are optimised for 2-channel operation. It is usually better to use the appropriate amplifier in 2-channel mode than to use an inadequate amplifier in bridged mode.

Gain or level settings

Gain switches

If you are lucky enough to have amplifiers with user gain switches, set them all to identical positions. A voltage gain in the range 23-33dB will provide a good balance of system headroom and noise (assuming professional audio equipment is in use FOH).

Level controls

The front panel level controls should be turned down (fully counter clockwise) until FOH-to-Amp rack lines have been checked and controllers have been set to suit the power amplifiers to be used (see [Section 1.5.2](#)). Music should be used to check that controllers are receiving and sending the appropriate signal bands and then each power amplifier level control advanced in sequence to check system operation and patching.

Assuming that controller output levels and limiters have been set as tabulated in [Section 1.5.2](#), power amplifier level controls should be set to full (fully clockwise) for loudspeaker sections requiring the strongest drive. Amplifiers driving nearer-field sections within the same cluster may be backed off as required for smooth coverage. This process will ensure that the cluster coverage remains balanced during limiting.

Rack mounting

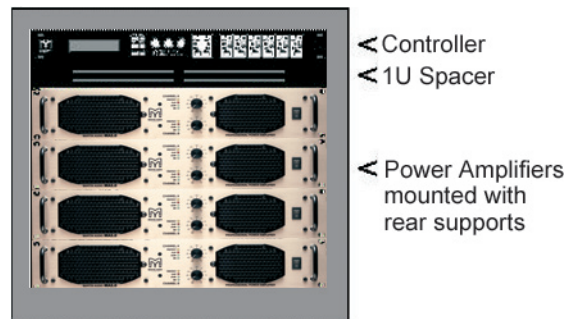

Always leave a 1U space between power amplifiers and controllers. Although most modern amplifiers don't radiate significant fields it's better to play safe and keep the system quiet. Rear supports are recommended - check with the manufacturer.

1.6.1 Martin Audio MA2.8 Overview



Features

- Switch mode power supply
- Superior sonic performance
- Light weight
- Advanced protection circuits
- Efficient copper cooling system
- Minimum load switches (MLS™)

The MA2.8 power amplifier has been designed to combine reliability and high power output with sonic excellence. Utilising an advanced switch mode power supply, the MA2.8 yields a very high power-to-weight ratio in a lightweight, 2U package.

See [MA2.8 Power Amplifier User's Guide](#) for detailed operating instructions.

Cooling System

The Martin Audio MA2.8 amplifier runs very cool due to a special patented copper cooling system. The amplifier's bi-polar output devices are mounted directly onto a copper heat sink (copper conducts heat twice as efficiently as aluminium) and maximum heat dissipation is achieved by turbulent airflow over the heatsink's geometric fins.

The MA2.8 amplifier features two proportional speed cooling fans which take in air from the front of the amplifier and exhaust from the rear. A horizontal pressure chamber between the heatsink and the cooling fans ensures that there is little difference in the operating temperatures of each output device. In contrast, a conventional tunnel design can result in a temperature variance of up to 40° between output devices.

Switch Mode Power Supply

The MA2.8's switch mode power supply (SMPS) is the modern solution to the problems of size and weight. Switch mode power supplies are not new - they are found in computers and televisions. However, the demands of high power audio are very different to these applications. The MA2.8 overcomes the size and weight constraints of conventional power supplies whilst at the same time avoiding the pitfalls of typical switch mode designs.

The low output impedance of the SMPS means that rail voltages do not sag under heavy load conditions. Additionally, the rail capacitors are being recharged at a much faster rate than those in a conventional power supply. The result is an exceptional fast transient low frequency performance at all power levels. Efficiency is also maximised. With much smaller transformers than a conventional supply, there is much less loss due to transformer resistance and much less power wasted as heat in the power supply.

The power amplifier will produce the same power output, even if the AC line voltage

drops by 20%.

Minimum Load Switches (MLS™)

Because the SMPS is regulated, the maximum power available for the output stages can be adjusted without increased heat dissipation or efficiency loss. This allows the user to match the output power with the loudspeaker impedance.

Protection

The MA2.8 amplifier has many advanced protection features that will protect both the amplifier and the speakers connected to it, under fault conditions. All protection circuits are independent and inaudible in normal use.

Clip Limiters

Clip limiters prevent dangerous clipped signals reaching the speaker. They work by monitoring the output to check for signals not present at the input i.e. distortion. If distortion exceeds 1% on an output, the limiter will reduce the input signal proportionally.

Thermal Protection

Thermal Protection circuitry prevents the amplifier from running at an unsafe temperature by muting the input signal when the internal temperature rises above 90°C.

Short Circuit Protection

The MA2.8 amplifier is completely short circuit protected. The protection circuits permit very high peak currents, but maintain the output devices within their safe operating area.

Mains Voltage Protection

This operates if the mains voltage falls outside its permitted operating range. If this occurs, the power supply will shut down until the correct mains voltage is restored.

DC and VHF Protection

Both DC voltages and high power VHF signals can cause damage to loudspeakers. The MA2.8 amplifier incorporates protection circuits which are activated when damaging DC voltages or VHF signals are present at the outputs.

MA2.8 Specifications

Input Impedance	20kohms (balanced) 10kohms single ended
Gain select switch	38dB (I/P sens 0.775V), 32dB (I/P sens 1.55V)
CMRR at 1kHz	>50dB
Output impedance at 1kHz	0.06 ohms
Power Bandwidth	10Hz - 20kHz
Slew rate	20V/us
Hum/Noise	<-105dB
Channel Separation	1Khz > 90dB 10Khz > 80dB

Mains Operating Voltage 120 - 270 (minimum start voltage 190)
full output power maintained 180 - 280V.
Optional (65 - 135V) operation.

Protection DC, High temperature, Turn on, VHF,
Over and under voltage, Clip limiters. Short circuit.

Distortion	
THD 20Hz - 20kHz and 1W – 1000W	4 ohms 0.08%
THD at 1kHz and 1100W	4 ohms 0.03%
DIM 30 at 500W	4 ohms 0.02%
CCIF (13 and 14 kHz) at 500W	4 ohms 0.03%
SMPTE (60Hz and 7kHz) at 500W	4 ohms 0.08%

Power Matrix

LOAD CONFIGURATION	MLS SWITCH SETTING			
	(-5dB)	(-4dB)	(-2dB)	(0dB)
16 ohms Stereo (2 channel)	160W	180W	340W	520W
8 ohms Stereo (2 channel)	300W	350W	650W	1100W
4 ohms Stereo (2 channel)	570W	680W	1100W	1400W
				1900W[2]
2 ohms Stereo (2 channel)	1040W	1200W	1200W	1400W[1]
			1400W[2]	2900W[2]
16 ohms Bridged mono	600W	700W	1300W	2000W
8 ohms Bridged mono	1200W	1400W	2200W	2800W
4 ohms Bridged mono	2100W	2400W	2400W	2800W[1]

[1] = Component tolerance dependent

[2] = Continuous power, one channel driven or peak power both channels driven. Thermal protection may occur at high continuous power.

Power in watts (EIA 1kHz, 1% THD)

Weight 10kg (22lbs)

Dimensions (W) 483mm x (H) 88mm x (D) 347mm
(W) 19ins x (H) 3.5ins x (D) 13.7ins

1.7 General operational summary

- 1) Always use the same model system controller and power amplifier for a particular Wavefront product. This avoids confusion caused by different controller topologies and power amplifiers voltage gains.
- 2) It is common practice to use mixing console matrix outputs as loudspeaker section controls. Whilst this is fine for creating a bass submix which can easily be judged from the mix position, it can be fraught with danger if used for audience sections which may only be audible in very specific areas. Trim these remote sections, during listening tests with a colleague via walkie talkie, using the relevant controller input gains. If the console matrix cannot be avoided, try to pre-calibrate its output levels controls to their 0dB (nominal) position initially. These settings will be easier to get back to and will avoid embarrassing level setting mistakes during the show - particularly if the system is being used by guest operators who may not be familiar with your particular matrix allocations.
- 3) And again, trim levels within clusters (eg farfield vs midfield or inners vs outers) using the amplifier level controls to ensure limiter tracking.

1.8 Arraying & placement

Simple stacked systems

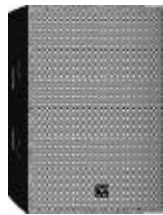

Single W8C

A single Wavefront W8C cabinet will cover 55° horizontally x 30° vertically and may be used as a stand-alone system for a variety of light music and voice applications including commercial presentations.

A W8C may be combined with a W8CS compact subwoofer or a WSX horn-loaded subwoofer to extend its low frequency performance.



Single W8C on W8CS subwoofer

This very compact stack may be used for as one side of a main system for a folk band concert in a small venue, one corner of a small dance floor system, stage side fills, stage drum fills, front fills etc.

SAFETY REMINDER!

Stacks should always be safety strapped to allow for high winds, over-exuberant artists, crowd indiscipline, scenery movements etc.

Wide coverage, broadband stack

Although a single Wavefront W8C's horizontal coverage is 55° at high frequencies, the system has been designed to integrate well with smaller splays for practical output summing. A splay of 40° between axes (260mm between cabinet front corners) provides very smooth 95° horizontal coverage with little increase in mid-band output level whilst a smaller splay angle (typically 30°) can boost the forward output level by 2-3dB.

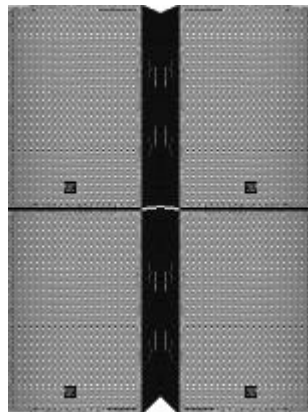

2-wide W8C/W8CS stack

This very compact stack may be used as one side of a small venue main system, one corner of a dance system, high power stage side fills, drum fills, centre fills etc.

Flown systems overview

Flown clusters are recommended for very high power music systems covering large venues to ensure adequate coverage without excessive levels at the front of the venue.

Wavefront series products are fitted with MAN load-certified flying points and are designed to comply with the 12:1 safety factor specified by the German VBG70 standard when used with compatible 12:1 flying systems.

MAN Transformer or Installer/Tourer flying systems allow columns of loudspeakers to be assembled by attaching individual loudspeakers to vertically daisy-chained D-rings using keyhole cabinet fittings - hence the tendency to base flown designs in this applications guide on multiple columns. The beauty of the MAN system is that each cabinet in a system supports only its own weight.

Each pair of vertical chains is attached to a single-width, centrally pivoted sub-bar which, in turn, is attached to a two-way, centrally pivoted flying bar so that the system “finds its own level”, if accidentally hoisted asymmetrically, avoiding undue stresses and strains.



Vertical splay angles are determined by intercabinet chain lengths whilst the overall column tilt is determined by the length of the chains between the upper cabinet and the sub-bar. **Please note that all components must have a 12:1 safety factor.**

Vertical columns are splayed by tensioning a ratchet strap threaded through the sub-bar and all of the cabinet back plates.



Cabinets may be fitted with rear hinge back plates to allow removable hinges to be slotted in place. These hinge assemblies provide a more rigid rear cabinet alignment.

For further information please refer to the Martin Audio Wavefront 8 Flying System User Guide.

Rigging Schools!

Rigging should not be undertaken by untrained or unqualified personnel.

Suitable rigging training sessions may be arranged by calling Martin Audio Ltd on +44 (0)1494 535312.

Important note on flown systems examples

Wavefront cluster examples are included in this manual to illustrate recommended loudspeaker combinations and splay angles only. Note that very large clusters - particularly those including Wavefront Longthrow elements - may need to be flown in multiple layers to maintain the 12:1 safety factor of the standard Martin Audio Wavefront 8 Flying System.

SAFETY NOTE!

Two female "keyhole" stud plates are fitted to each side of Wavefront cabinets to allow cabinets to be flown up-side-down for certain applications. The upper keyhole is the only one ever used - whatever the configuration.

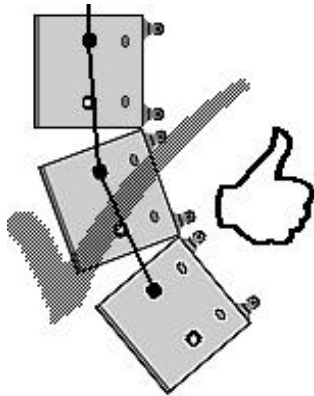

OK

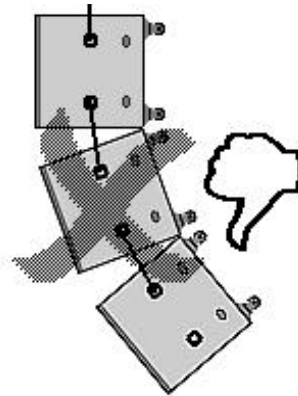

No, No, No!!!

- i) NEVER suspend one cabinet from the lower flying point of the cabinet above.
- ii) NEVER suspend standard cabinets horizontally.



Two Wavefront Compact W8Cs correctly rigged using upper key-holes only

1.9 Coverage calculations

Single W8C column

Here is an example of a 1-wide, 3 deep column of Wavefront W8Cs.

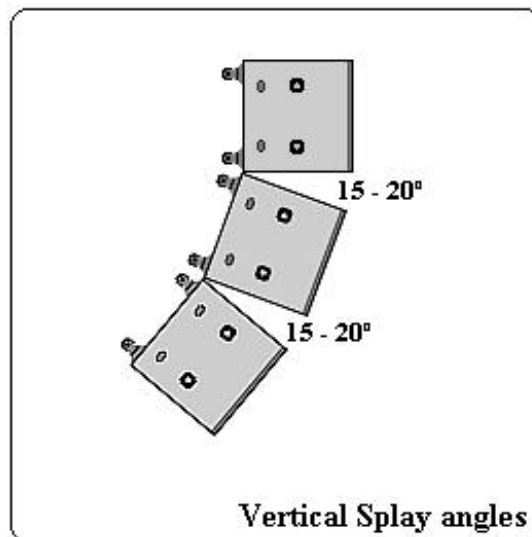

The horizontal coverage is, of course, that of a single W8C ie 55°.

The vertical coverage of a W8C cluster can be calculated as follows:

Vertical coverage of a W8C = the vertical coverage of a single W8C (30°) + the sum of all the vertical splay angles

For a 3-deep W8C cluster with 15° vertical splay angles = $30^\circ + 15^\circ + 15^\circ = 60^\circ$

For a 3-deep W8C cluster with 20° vertical splay angles = $30^\circ + 20^\circ + 20^\circ = 70^\circ$

Double W8C column

Here is a 2 wide, 3 deep column of Wavefront W8Cs.

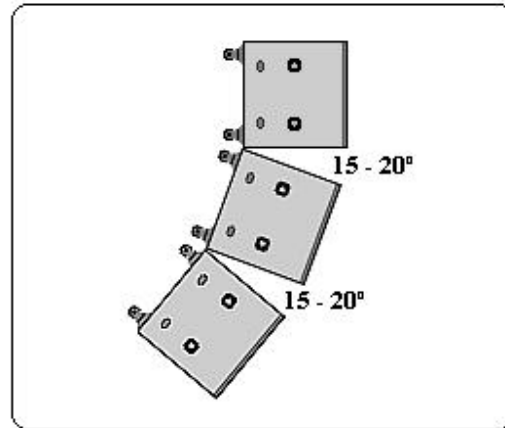
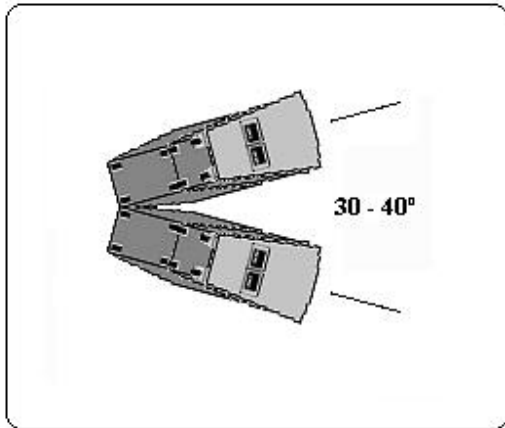
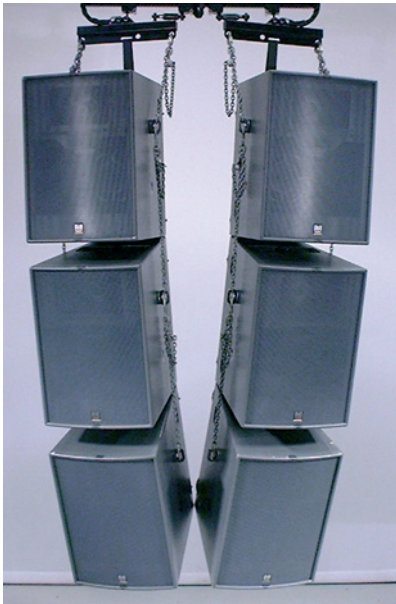

The vertical coverage can be calculated as follows:

For a 3-deep W8C cluster with 15° vertical splay angles = $30^{\circ} + 15^{\circ} + 15^{\circ} = 60^{\circ}$

For a 3-deep W8C cluster with 20° vertical splay angles = $30^{\circ} + 20^{\circ} + 20^{\circ} = 70^{\circ}$

The horizontal coverage can be calculated as follows:

For a 2-wide W8C cluster with 30° horizontal splay angles = $55^{\circ} + 30^{\circ} = 85^{\circ}$

For a 2-wide W8C cluster with 40° horizontal splay angles = $55^{\circ} + 40^{\circ} = 95^{\circ}$

Wide coverage cluster

4 or 6 wide, 4 deep W8C clusters may be rigged for very wide coverage. Coverage may be calculated as follows:

6 wide cluster

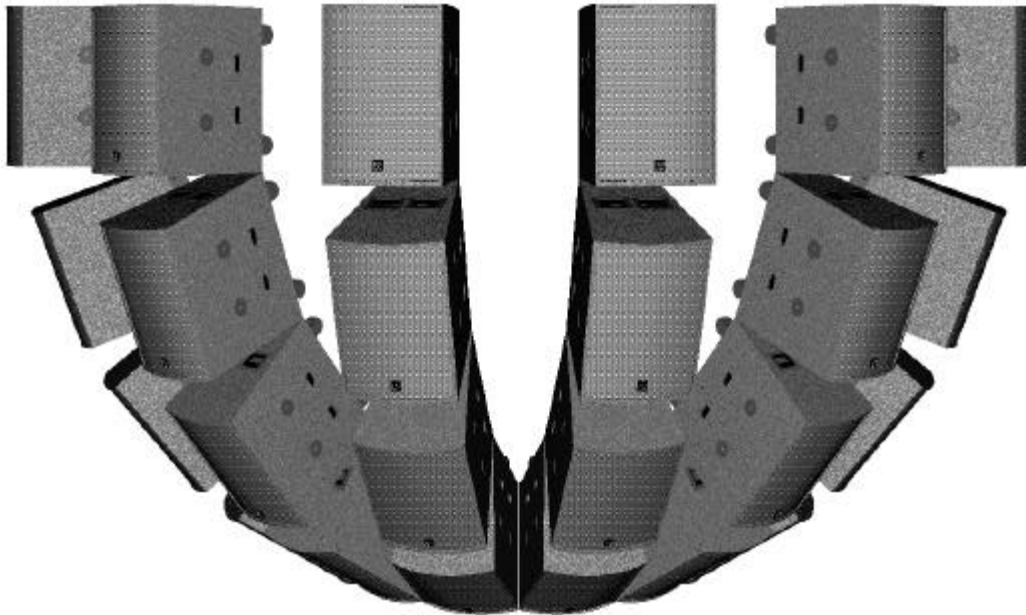

The horizontal coverage now extends to:

$$55^{\circ}+30^{\circ}+30^{\circ}+30^{\circ}+30^{\circ}+30^{\circ} = 205^{\circ} \text{ for } 30^{\circ} \text{ horizontal splays}$$

$$55^{\circ}+40^{\circ}+40^{\circ}+40^{\circ}+40^{\circ}+40^{\circ} = 255^{\circ} \text{ for } 40^{\circ} \text{ horizontal splays}$$

and the vertical coverage extends to:

$$30^{\circ}+15^{\circ}+15^{\circ}+15^{\circ} = 75^{\circ} \text{ for } 15^{\circ} \text{ vertical splays}$$

$$30^{\circ}+20^{\circ}+20^{\circ}+20^{\circ} = 90^{\circ} \text{ for } 20^{\circ} \text{ vertical splays}$$

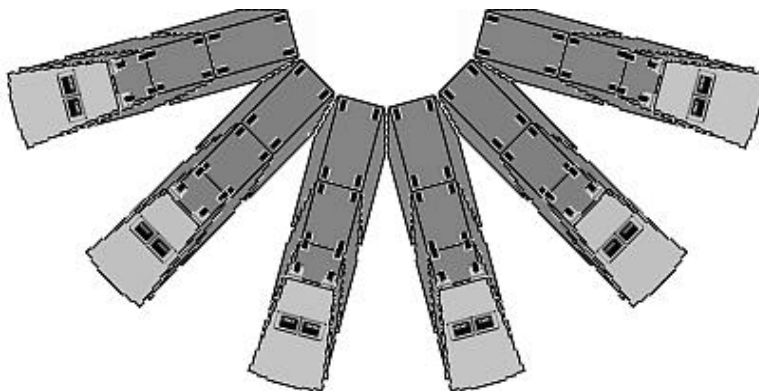

6 wide, 4 deep plan view

Circular cluster

Two 6-wide, 4 deep W8C clusters with 30° horizontal splay angles and 20° vertical splay angles may be flown back-to-back to provide full 360° horizontal x 90° vertical coverage for ice shows, for example.

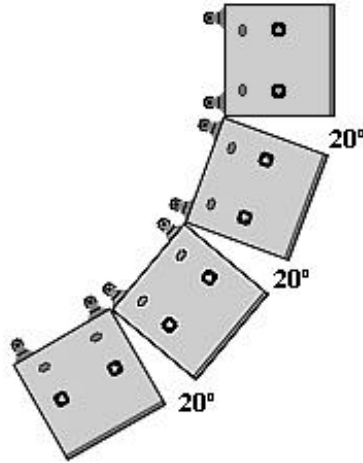

Column View

Note that the 90° coverage allows foldback to be provided to the ice-dancers. The centre hole may be filled by flying a smaller cabinet underneath the main cluster.

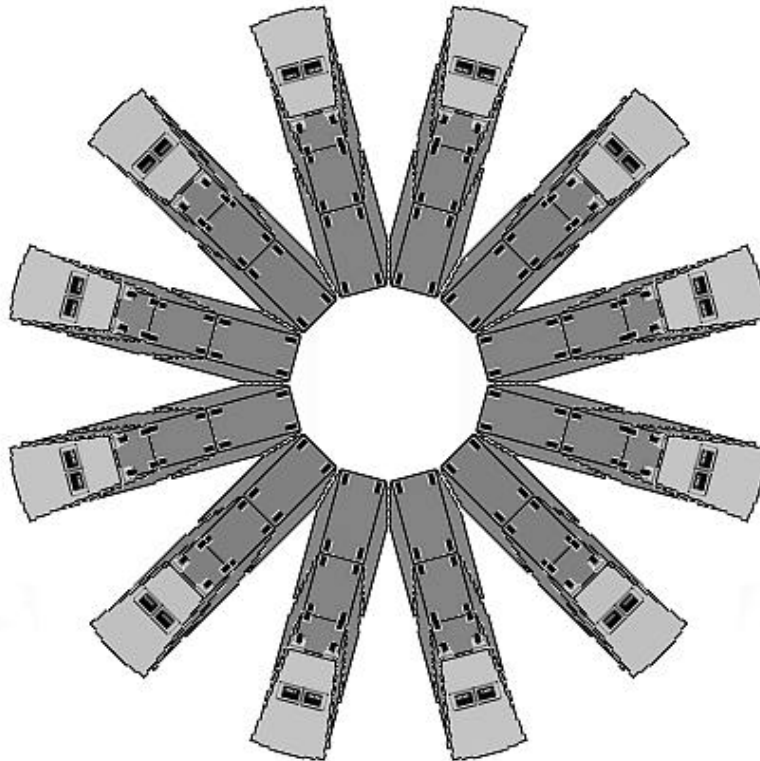

Circular, 4 Deep W8C cluster

1.10 W8Cs as front fills

Wavefront W8Cs may be used as stage apron fills for high power rock concerts. When carefully placed on radii converging at the centre downstage (lead vocal) area and synchronised with the main PA downfills, these apron fills don't just balance the subwoofers. They can focus vocals and add a detailed quality that can be beneficial right out to the mix position.

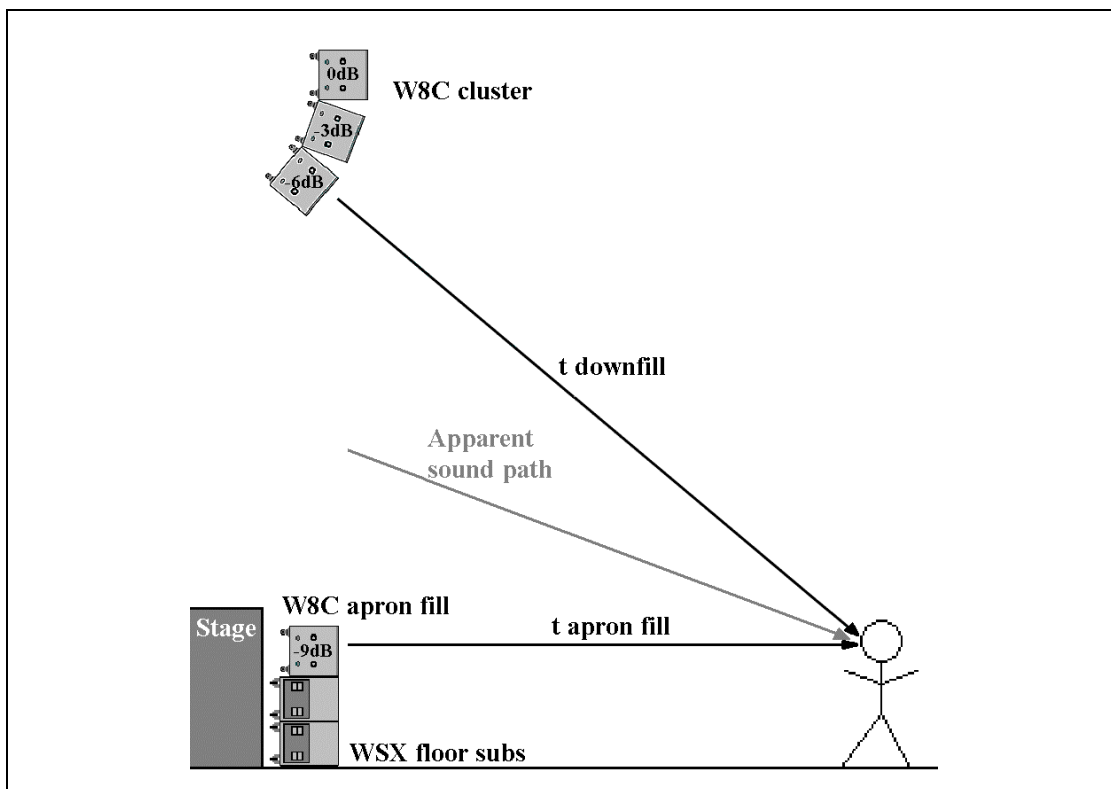
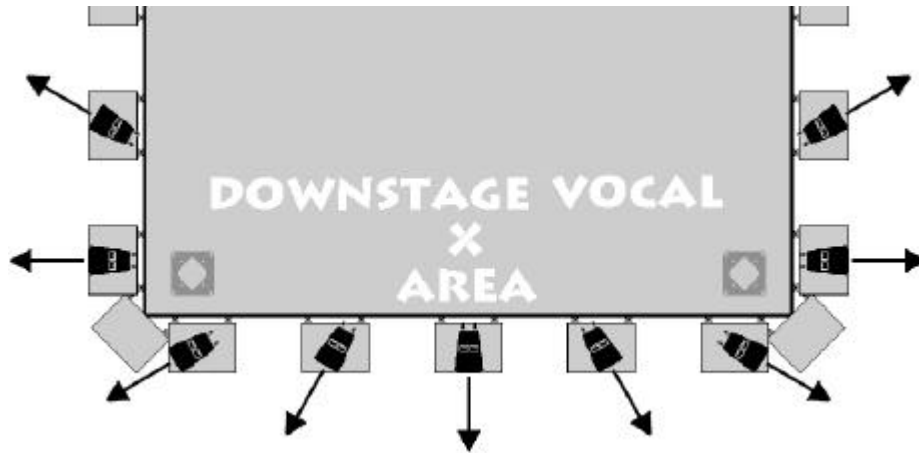

If the apron fill loudspeaker signal is delayed by the difference between the downfill propagation time and the apron fill propagation time and attenuated by the ratio of those propagation times, the sound will appear to come from an area in between the two systems for the listener shown.

<p style="text-align: center;">Apron fill delay line setting = t downfill - t apron fill</p> <p style="text-align: center;">Apron fill gain setting wrt downfill gain = $20\log^{10}(t \text{ downfill} \div t \text{ apron fill})$ dB</p>

1.11 W8Cs as side clusters

A Wavefront Longthrow (See [Section 2](#)) centre cluster may be used with W8C downfills for efficient operatic and orchestral amplification. Velodrome side seats can be some distance away (typically across a wide cycle track) so fairly powerful side clusters may be required for good projection and intelligibility.

W8Cs are ideal for this application as they blend in sonically without off-axis lobing and stage mic colouration.

Deep orchestral stage continues this way ↑

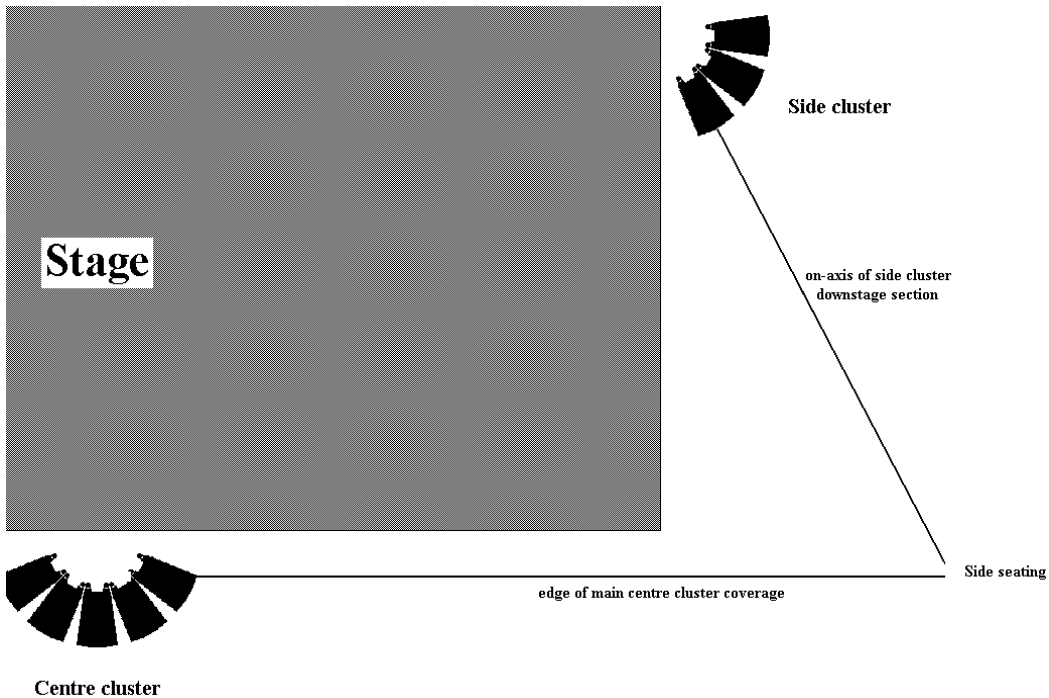

To avoid abrupt changes in timbre between the side and centre cluster, the side downstage W8C axis should be aimed at the seating where the centre cluster is *just* beginning to lack very high frequencies.

Controller output levels and delays should be adjusted so that the side and centre clusters are at the same level and synchronised in the same area.

1.12 W8Cs in distributed (delay) systems

Wavefront W8C Compacts make very good high power distributed systems or delay elements as they project sound smoothly and efficiently without local off-axis lobing.

For good overall coverage, delays are best driven in mono for most of the show although computer controlled matrix mixes may be considered for panning spot effects around the venue.

Flown radial delays

Flown distribution or delay loudspeakers should be placed on radii converging at the stage and staggered for smooth coverage.

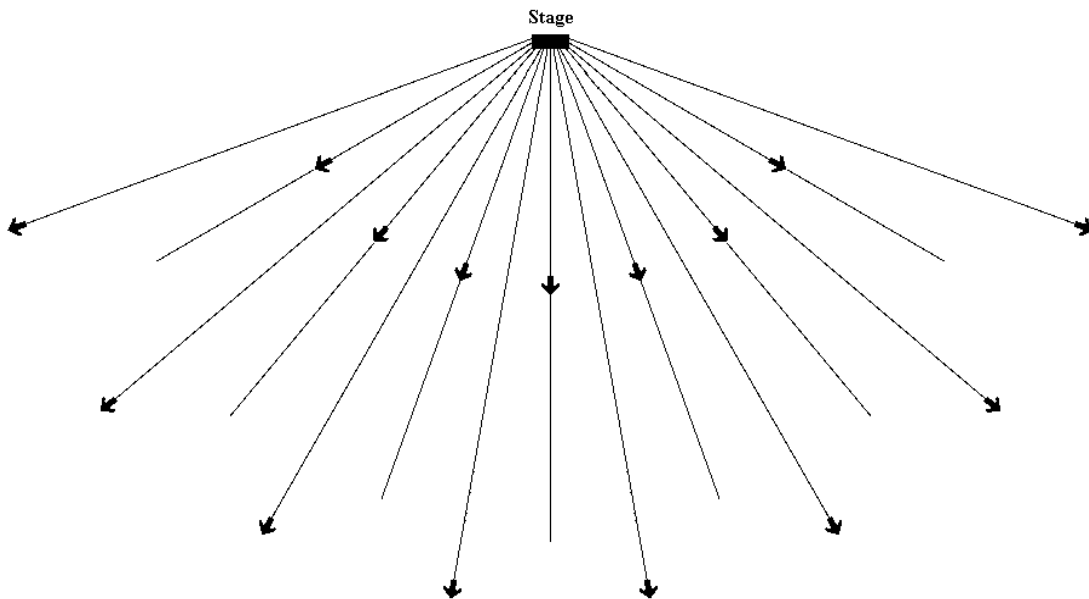

Distributed flown loudspeaker plan (stage system not shown)

Delay times should be set for synchronisation with the next most powerful source. This would be the stage for the first row of delays (below left) or the previous row (below right) for farfield delays.

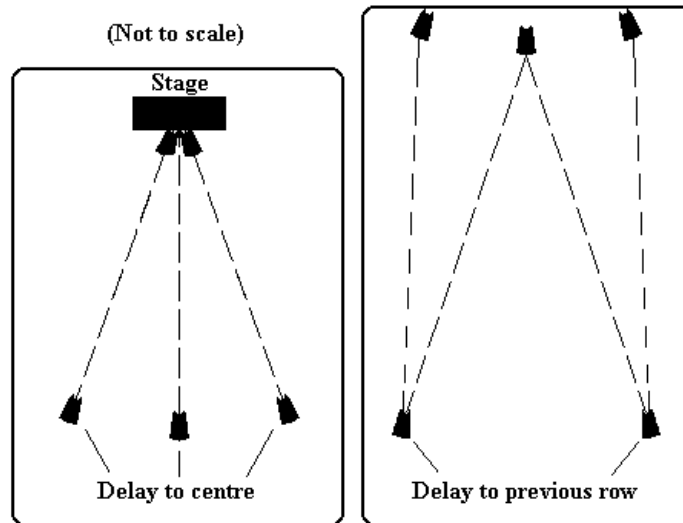

Synchronising flown central delays

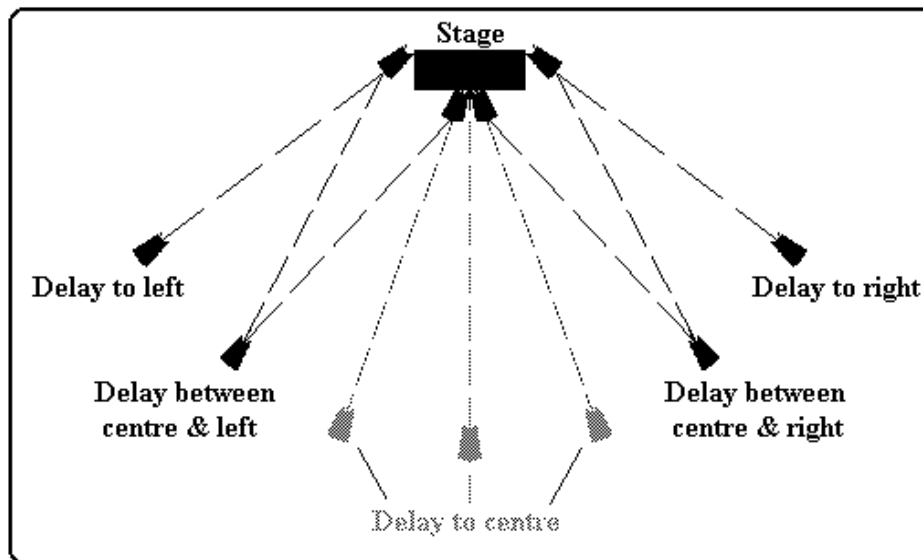

Synchronising flown outer delays

Ideally, the sound should be perceived as coming from the stage over the whole audience area - which means that all the delay loudspeakers should be aligned with the stage opening. In practice, sight line, follow spot and camera shot restrictions will affect placement for heavily raked seating areas and intelligent compromises will need to be made.

Delay systems should be thoroughly checked over a wide listening area to ensure that their level settings provide smooth coverage without hot spots. Delay times and levels should be finely adjusted to minimise multiple arrivals in seating areas where systems cannot be in line with the stage and more than one source can be heard.

Aiming delay tower loudspeakers

Multiple delay tower loudspeakers should be tilted so that they aim towards head height at the next tower to mask off-axis tower leakage and to minimise multiple arrivals further out.

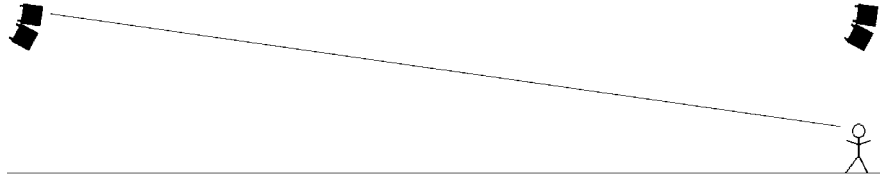

Synchronising multiple tower systems (not to scale)

Small delay time errors are inevitable where delay towers are located in audience areas (eg on a football field) due to the three dimensional geometry involved.

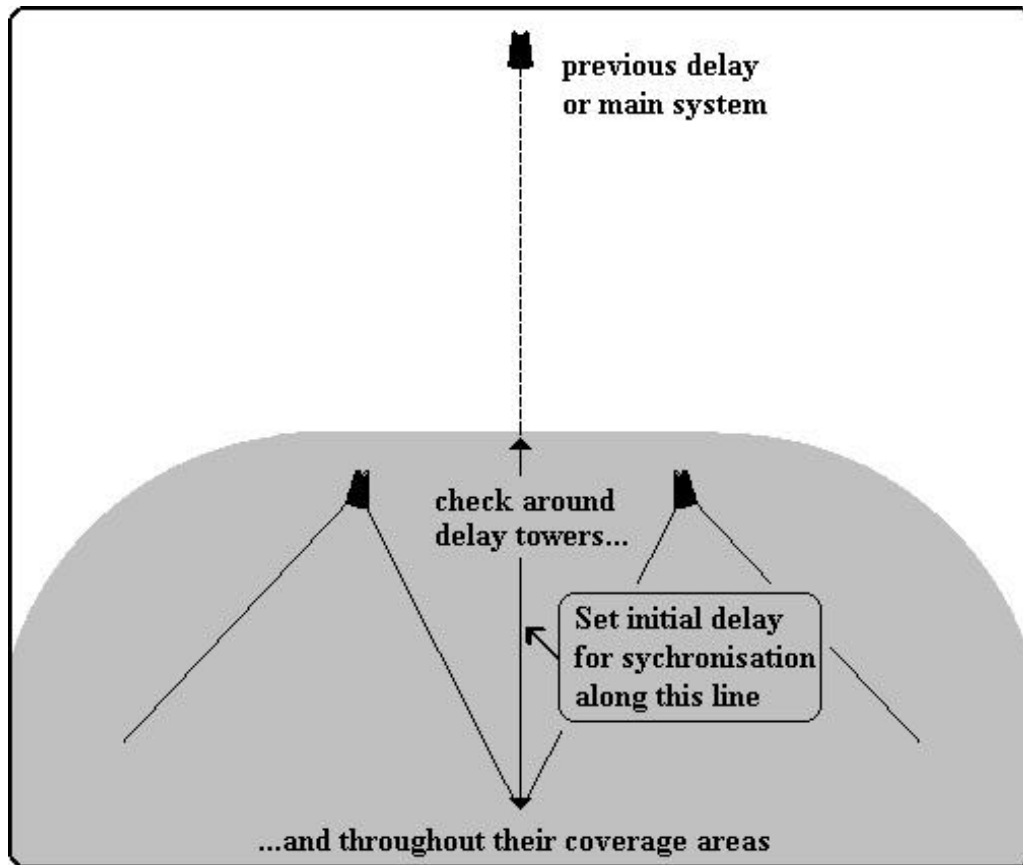

Initially, controller delays should be adjusted for synchronisation along a line between staggered delay towers and then modified as necessary to minimise timing errors around each tower and over its main coverage area.

Wavefront Compact Series

Applications Guide

Section 2

Wavefront Longthrow W8CT & W8CM Line Array System



The Martin Experience

All material © 2007. Martin Audio Ltd. Subject to change without notice.

Section 2

Wavefront Longthrow W8CT & W8CM Line Array System

Contents

- [2.1](#) **Introduction**
- [2.2](#) **Specifications**
- [2.3](#) **Pin-outs and cabling**
- [2.4](#) **System patching**
- [2.5](#) **DX1 gain & limiter settings**
- [2.6](#) **Power amplifier recommendations**
- [2.7](#) **General system reminders**
- [2.8](#) **Coverage**
- [2.9](#) **Further examples**

Section 2a

Climatic effects on sound propagation

- [2a.1](#) **Introduction**
- [2a.2](#) **Wind effects**
- [2a.3](#) **Temperature effects**
- [2a.4](#) **Relative humidity effects**

Wavefront Longthrow W8CT & W8CM Line Array System



2.1 Introduction

The Martin Audio Wavefront Longthrow W8CT & W8CM Line Array System is a compact, light weight, very high power, multiple horn line array loudspeaker system in a trapezoidal cabinet sharing design concepts and footprints with the rest of the popular Martin Audio Wavefront Compact family.

Unlike other manufacturers who have been rushed into production to exploit the recently recognised benefit of line array systems, Martin Audio have manufactured modular line array systems for many years. The Martin Audio Wavefront Longthrow system benefits from this proven track record. It uses established components and stacked horn techniques to provide a sensible, arrayable horizontal performance compatible with the rest of the Wavefront family.

Although designed to be rigged in continuous columns for very long throw operation, Wavefront Longthrow elements may also be used within W8C clusters to provide spot coverage to distant balcony or corner seating.

The Wavefront Longthrow W8CT integrates three horn-loaded 6.5" high-mid drivers with six horn-loaded 1" high frequency compression drivers. Like the award-winning W8C high-mid system, the W8CT high-mid driver is optimally loaded using a toroidal phase plug to produce much lower distortion than a typical waveguide-loaded compression driver.

The Wavefront Longthrow W8CM comprises two horn-loaded 12" low-mid drivers to complement W8CT high-mid/high systems.

Wavefront Longthrow W8CTs and W8CMs are fitted with MAN load-certified flying points designed to comply with the 12:1 safety factor to the German VBG70 standard when used with compatible 12:1 flying systems.

2.2 Specifications

W8CT

Type:	Dedicated longthrow high-mid/high enclosure
Frequency response:	750Hz-18kHz +/- 3dB
Drivers:	3 x 6.5" (165mm) high-mid horn 6 x 1" (25mm) exit hf compression driver
Rated power:	High-mid 450W AES, 1800W peak High 360W AES, 1440W peak
Sensitivity:	High-mid 113dB High 115dB
Maximum SPL:	High-mid: 139dB continuous, 145dB peak High: 141dB continuous, 147dB peak
Impedance:	High-mid: 6 ohms nominal High: 2 x 6 ohms nominal
Coverage (-6dB):	55° horizontal, Line vertical (see Section 2.8)
Crossover:	750Hz, 3.5kHz
Connectors:	2 x Neutrik NL8
Cabinet construction:	Birch Ply
Cabinet finish:	Slate textured paint
Protective grille:	Perforated steel
Grille finish:	Grey paint
Dimensions (incl wheels):	(W) 562mm x (H) 799mm x (D) 925mm (W) 22.1ins x (H) 31.5ins x (D) 36.4ins
Flown weight:	81kg (178lb). Lid 4kg (9lb) extra

W8CM

Type:	Dedicated longthrow low-mid enclosure
Frequency response:	120Hz-750Hz +/- 3dB
LF limit:	-10dB @ 80Hz
Drivers:	2 x 12" (305mm) low-mid horn
Rated power:	600W AES, 2400 peak
Sensitivity:	109dBspl/W
Maximum SPL:	136dBspl continuous, 142dBspl peak
Impedance:	4 ohms

Coverage (-6dB):	55° horizontal, Line vertical (see Section 2.8)
Crossover:	120Hz, 750Hz
Connectors:	2 x Neutrik NL8
Cabinet construction:	Birch Ply
Cabinet finish:	Slate textured paint
Protective grille:	Perforated steel
Grille finish:	Grey paint
Dimensions (incl wheels):	(W) 562mm x (H) 799mm x (D) 925mm (W) 22.1ins x (H) 31.5ins x (D) 36.4ins
Flown weight:	72kg (158lb). Lid 4kg (9lb) extra

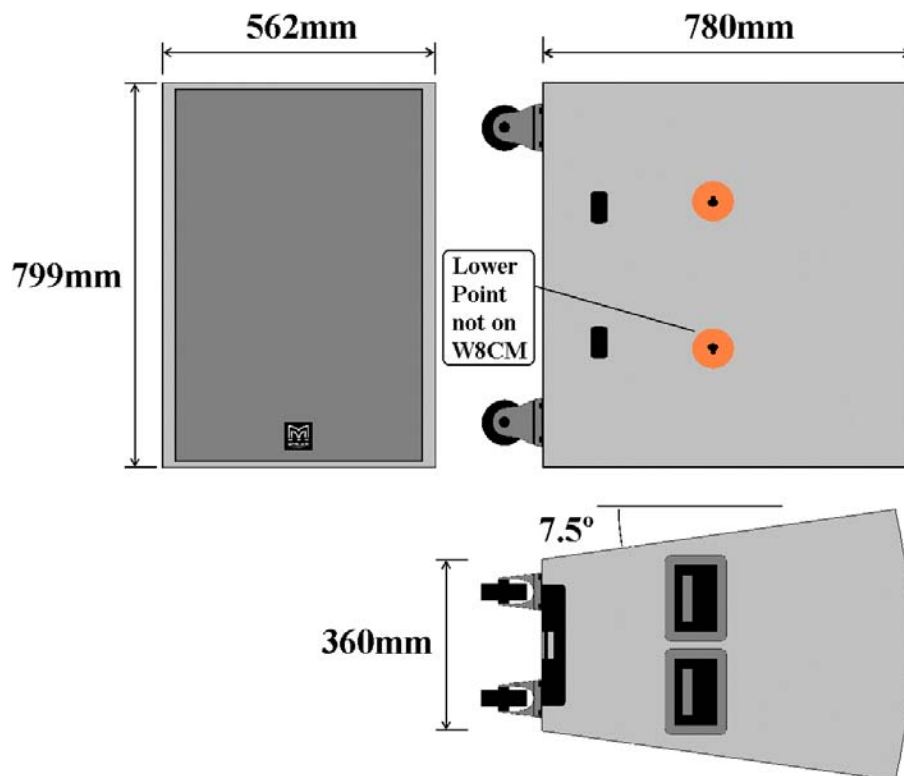

Before rigging, note colour coding!

**W8C has 2 black points per side
W8CS has 1 black point per side**

**W8CT has 2 orange points per side
W8CM has 1 orange point per side**

2.3 Pin-outs and cabling

W8CT & W8CM		
NL8	W8CT	W8CM
-1	Link through	Low Mid -
+1	Link through	Low Mid +
-2	High Mid -	Link through
+2	High Mid +	Link through
-3	High 1 -	Link through
+3	High 1 +	Link through
-4	High 2 -	Link through
+4	High 2 +	Link through

(See [Section 1.3](#) for connector pin-out drawing)

2.3.1 Cable and panel connector part numbers

Please note the following part numbers when ordering loudspeaker connectors to make up cables and patch panels.

Neutrik NL connectors	
NL8FC	8 pole cable (female)
NL8MPR	8 pole panel (male)
NL8MM	8 pole inline coupler (male-male)

Connectors should be kept in good, clean, uncorroded condition to ensure full, undistorted loudspeaker performance. Corroded or damaged pins and sockets can cause severe distortion or loss of signal.

2.3.2 Recommended loudspeaker cable

Note that a standard 8-core loudspeaker cable will drive through-linked pairs of W8CTs and W8CMs.

The following table gives suitable copper core specifications for common applications:

Cable run vs copper core cross sectional area



	One W8CT or W8CT/CM combination	Two W8CTs in parallel or two W8CT/CM combinations in parallel at the cluster.
Up to 50m	4mm ² (or 2x 2.5mm ² cores in parallel)	10mm ² (or 2x 4mm ² cores in parallel)
Up to 100m	10mm ² (or 2x 4mm ² cores in parallel)	Not recommended - but use 2x 10mm ² cores in parallel if you must.

Q. Why the odd sizes?
A. Loudspeaker cables are available in a limited range of standard copper core sizes - ie. 1.5mm², 2.5mm², 4mm², 6mm², 10mm² and 35mm².

2.4 System patching

A good system patch should:

- 1) Be electrically safe - ie be put together by suitably qualified electrical technicians
- 2) Enable the system to provide the required sound quality, coverage and level without feedback and without stressing its mechanical, electrical or electro-acoustic components.
- 3) Be divided into easily understood sections (eg Main, midfield, downfill etc) and clearly labelled so that adjustments may be made quickly and efficiently.

Although the last two points may seem insultingly obvious to users who are naturally well organised, they are very important. Each Longthrow section may be covering several thousand people and fairly minor mis-patches can have major consequences bearing in mind that outdoor events - particularly orchestral concerts - are often competing with noise from food and drink stand generators, over-flying aircraft, local traffic etc.

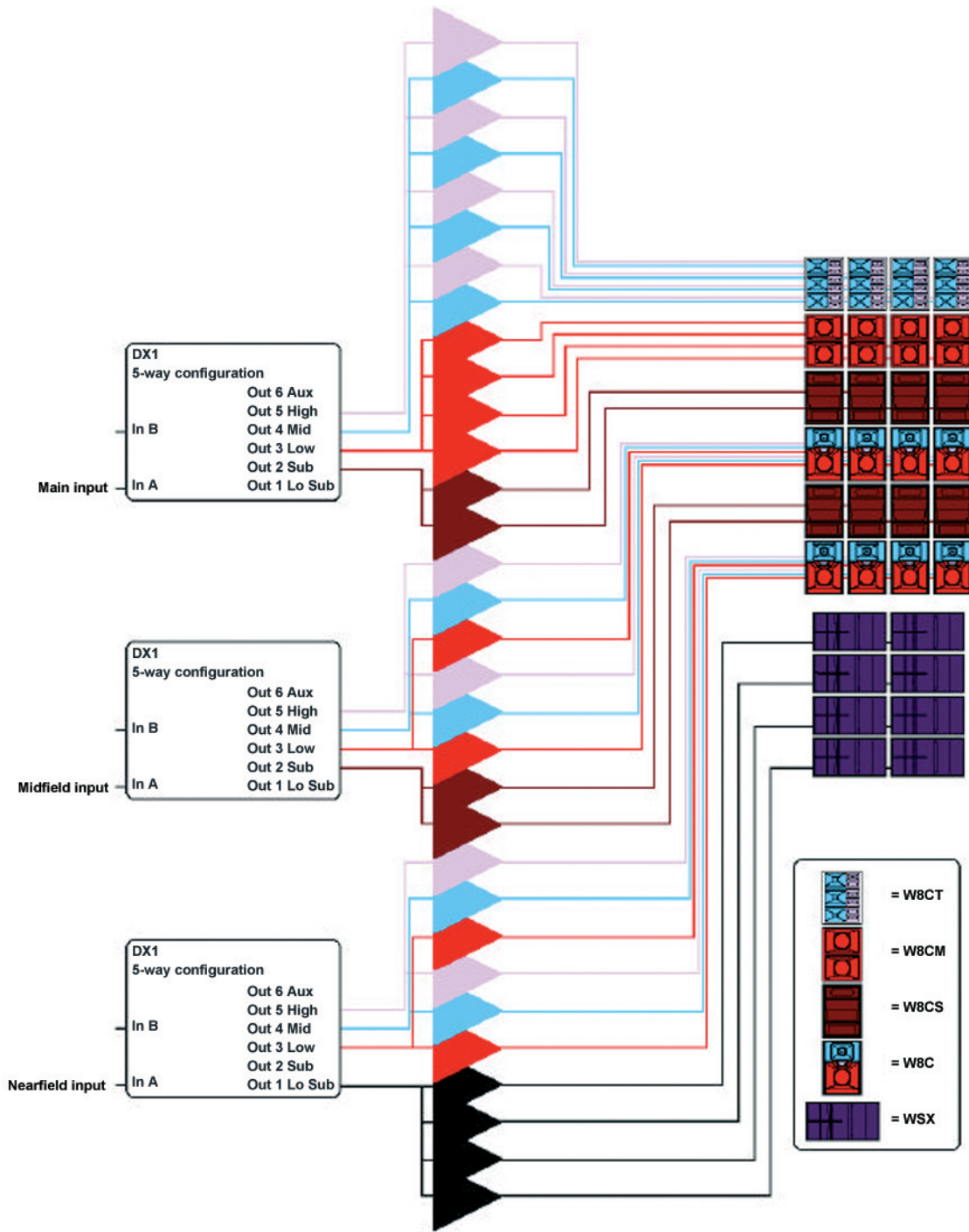

The above schematic shows a typical system incorporating a row of Wavefront Longthrow W8CT & W8CM elements with Wavefront Compact W8Cs and W8CS' crossed over as flown mid-bass sections to augment floor stacked WSX subwoofers.

The system uses Martin Audio DX1 Loudspeaker Management Systems configured as 5-way crossovers. Martin Audio can provide factory set configuration cards for a variety of off-the-shelf crossover systems (contact your dealer or Martin Audio for further information) but, the Martin Audio DX1 Loudspeaker Management System is strongly recommended for all new Wavefront Longthrow system designs. See [Section 1.5](#) for DX1 details.

For further notes on system patching, including cluster sub-section controller and amplifier allocations see [Section 1.4](#).

2.5 DX1 gain & limiter settings

Standardising on one good model of power amplifier (preferably the [Martin Audio MA2.8](#)) and correctly set-up controller (preferably the [Martin Audio DX1](#)) will provide the most dynamic system performance and protection whilst simplifying design and reducing spares inventories.

The Martin Audio DX1 Loudspeaker Management System may be user-programmed for a wide range of touring configurations based on its 2 input + sum, 6 output matrix. This operation is best completed by an audio technician who is familiar with DSP - based pro-audio equipment. (See [Section 1.5](#) and [DX1 Speaker Management System User's Guide](#) for further details)

Gain settings

The following initial DX1 output gain settings will enable full system performance to be obtained whilst keeping the console and drive system noise floors inaudible and avoiding amplifier slew-rate limiting:

W8CT & W8CM - assuming 600Wcont - 1200Wpk into 4Ω power amplifiers:						
Best-fit Amplifier Example	Amplifier		Amplifier Gain dB	Initial DX1 Output <u>GAIN</u>		
	Sensitivity dBu	Vrms		Lomid dB	Himid dB	High dB
Martin MA2.8* (38dB)	-2	0.62	38	-9	-9	-9
Crest CA9 (x68)	-1	0.69	37	-8	-8	-8
Crown MA1202 (0.775v)	0	0.77	36	-7	-7	-7
	+1	0.87	35	-6	-6	-6
QSC PL224	+2	0.98	34	-5	-5	-5
	+3	1.09	33	-4	-4	-4
Martin MA2.8* (32dB)	+4	1.23	32	-3	-3	-3
Crest 4801 (x40)	+4	1.23	32	-3	-3	-3
Crown K1 (1.4v)	+4	1.23	32	-3	-3	-3
QSC PL218/218A (32dB)	+4	1.23	32	-3	-3	-3
QSC PL224A (32dB)	+4	1.23	32	-3	-3	-3
Crown MA1202 (1.4v)	+5	1.38	31	-2	-2	-2
	+6	1.55	30	-1	-1	-1
	+7	1.73	29	0	0	0
	+8	1.95	28	+1	+1	+1
	+9	2.18	27	+2	+2	+2
Crown MA1202 (26dB)	+10	2.45	26	+3	+3	+3
Crown K1 (26dB)	+10	2.45	26	+3	+3	+3
QSC PL218A (26dB)	+10	2.45	26	+3	+3	+3
QSC PL224A (26dB)	+10	2.45	26	+3	+3	+3

* Set MA2.8 rear MLS switch to -2dB.

Cluster balance (eg inner-to-outer) should be adjusted **at the power amplifier controls** to maintain limiter tracking. See [Section 2.7](#).

Balancing the system using gain controls in the signal path *before* the power amplifiers is not recommended as it will cause the higher signal level upper rows of a big cluster to start limiting before the lower signal levels downfills causing tonal changes at the mix position.

Limiter settings

The Rated Power specifications in [Section 2.2](#) show that the maximum allowable power dissipation depends on the driver/s being driven. This is because big low and low-mid drivers are capable of dissipating more heat than smaller mid-high and high drivers.

Normal music and speech signals, however, are a combination of relatively low general power levels with a multiplicity of short term transients. These short term transients do not significantly heat the driver voice coils so it is quite permissible to use the same 250-300W into 8Ω (500-600W into 4Ω) power amplifiers for all sections of the W8CT and W8CM [as long as they are sourced by a correctly set controller](#).

When choosing power amplifiers, do not be tempted to exceed the 250-300W into 8Ω (500-600W into 4Ω) power rating unless the amplifier's power rails are well regulated (see [Section 2.6](#)) - even with properly set controllers in place. Although Martin Audio drivers are mechanically designed to survive normal road use and the occasional operator error, overpowered or bridged amplifiers can cause over-excursions that stress and age drivers. The best way to get the clean, relaxed sound of an overpowered amplifier is to choose an amplifier with plenty of current reserve - ie an amplifier with good 2Ω specification - and avoid running more than two cabinets in parallel.

To ensure transparent limiter operation without obvious distortion or pumping, the DX1 limiter attack and release times are factory preset to be inversely proportional to each band's high pass frequency as follows:

High pass filter range	Attack time	Release time
>31Hz	45mS	720mS
31Hz - 63Hz	16mS	256mS
63Hz - 125Hz	8mS	128mS
125Hz - 250Hz	4mS	64mS
250Hz - 500Hz	2mS	32mS
500Hz - 1KHz	1mS	16mS
1KHz - 2KHz	0.5mS	8mS
2KHz - 22KHz	0.3mS	4mS

These attack times allow the power amplifiers to clip momentarily - but not for long enough to be obvious to listeners or cause driver overheating. It is quite normal to see amplifier clip indicators on the odd programme peak but continuous clipping would indicate a cable short circuit, wrong controller settings, excessive power amplifier gain or low mains voltage.

The following DX1 output limiter settings will avoid voice coil overheating and minimise amplifier clipping for high quality, trouble free operation.

W8CT & W8CM - assuming 600Wcont - 1200Wpk into 4Ω power amplifiers:						
Typical Amplifier Example	Amplifier Sensitivity		Amplifier Gain dB	Recommended DX1 <u>LIMITER</u> Settings		
	dBu	Vrms		Lomid dBu	Himid dBu	High dBu
<u>Martin MA2.8* (38dB)</u>	-2	0.62	38	-3	-6	-9
Crest CA9 (x68)	-1	0.69	37	-2	-5	-8
Crown MA1202 (0.775v)	0	0.77	36	-1	-4	-7
QSC PL224	+1	0.87	35	0	-3	-6
	+2	0.98	34	+1	-2	-5
	+3	1.09	33	+2	-1	-4
<u>Martin MA2.8* (32dB)</u>	+4	1.23	32	+3	0	-3
Crest 4801 (x40)	+4	1.23	32	+3	0	-3
Crown K1 (1.4v)	+4	1.23	32	+3	0	-3
QSC PL218/218A (32dB)	+4	1.23	32	+3	0	-3
QSC PL224A (32dB)	+4	1.23	32	+3	0	-3
Crown MA1202 (1.4v)	+5	1.38	31	+4	+1	-2
	+6	1.55	30	+5	+2	-1
	+7	1.73	29	+6	+3	0
	+8	1.95	28	+7	+4	+1
	+9	2.18	27	+8	+5	+2
Crown MA1202 (26dB)	+10	2.45	26	+9	+6	+3
Crown K1 (26dB)	+10	2.45	26	+9	+6	+3
QSC PL218A (26dB)	+10	2.45	26	+9	+6	+3
QSC PL224A (26dB)	+10	2.45	26	+9	+6	+3

* Set Martin Audio MA2.8 rear MLS switch to -2dB.



2.6 Power amplifier recommendations

Wavefront Longthrow loudspeakers have been designed and manufactured for very high performance over great distances. They are very easy - particularly if power amplifier racks and controllers are standardised within a system.

Power capability

W8CTs and W8CMs will provide full performance when driven by professional power amplifiers capable of delivering undistorted output power into a range of loads as follows:

W8CT & W8CM

250-300W(av) into 8 ohms,

500-600W(av) into 4 ohms

and

1,000-1,200W(av) into 2 ohms.

Please note:

Amplifiers with inadequate headroom before clipping may age high frequency components due to excessive signal density.

Amplifiers with excessive output may damage voice-coils or age driver suspensions due to excessive heat dissipation and excursion.

A note about power amplifier output specifications

Most power amplifier manufacturers keep their costs down by using unregulated supply rails which sag under load. To allow for this sag, manufacturers set their rails high so that they still meet their quoted output into specified loads. These high rail voltages allow such power amplifiers to provide outputs 1.5 - 2 times their quoted power for short-term bursts. Martin Audio products will withstand this potential doubling of instantaneous power - [with suitably set controller limiters](#) - but further, long-term increases caused by oversized amplifiers should be avoided.

Martin Audio MA series power amplifiers have regulated rails so it is quite permissible to use slightly overpowered models - [with suitably set controller limiters](#) - without risking uncontrolled power bursts. The MA series power amplifiers' regulated power rails also ensure maximum performance under the real-world concert conditions of less-than-optimum mains supplies and low impedance loads.

See [Section 1.6.1](#) for information on the Martin Audio MA2.8 power amplifier.

Amplifier load tolerance

An efficient loudspeaker in live concert conditions can act as a surprisingly dynamic and complex load. Most modern touring power amplifiers claim 2 Ohm capabilities but make sure your amplifier is also capable of driving reactive (ie inductive or capacitive) loads without prematurely clipping or developing output stage crossover distortion.

Power Reserve

Most power amplifier specifications are based on bench measurements made using stable, high current mains supplies and well defined loads.

Amplifiers sound best when they have plenty of current in reserve for musical peaks.

General power amplifier reminders

- 1) Try to ensure that the mains supply stays within the amplifier manufacturer's specified range from no load to maximum load. An electrical technician should check the mains supply vs demand using an accurate true rms voltage meter.
- 2) If unfamiliar generators are being used the electrical technician should check the mains waveform (using a portable 'scope-meter) to make sure that it is sinusoidal and not crawling with spikes or interference.
- 3) Avoid driving more than one W8CT high-mid or high section or one W8CM cabinet per power amplifier channel. This will keep the power amplifier's 2 ohm capability in reserve for musical peaks.
- 4) Avoid using power amplifiers in bridged mode. Most commercial power amplifiers are optimised for 2-channel operation. It is usually better to use the appropriate amplifier in 2-channel mode than to use an inadequate amplifier in bridged mode.

Gain or level settings

Gain switches

If you are lucky enough to have amplifiers with user gain switches, set them all to identical positions. A voltage gain in the range 23-33dB will provide a good balance of system headroom and noise (assuming professional audio equipment is in use FOH).

Level controls

The front panel level controls should be turned down (fully counter clockwise) until FOH-to-Amp rack lines have been checked and controllers have been set to suit the power amplifiers to be used (see [Section 2.5](#)). Music should be used to check that controllers are receiving and sending the appropriate signal bands and then each

power amplifier level control advanced in sequence to check system operation and patching.

Assuming that controller output levels and limiters have been set as tabulated in [Section 2.5](#), power amplifier level controls should be set to full (fully clockwise) for loudspeaker sections requiring the strongest drive. Amplifiers, driving nearer-field sections within the same cluster, may be backed off as required for smooth coverage. This process will ensure that the cluster coverage remains balanced during limiting.

Rack mounting

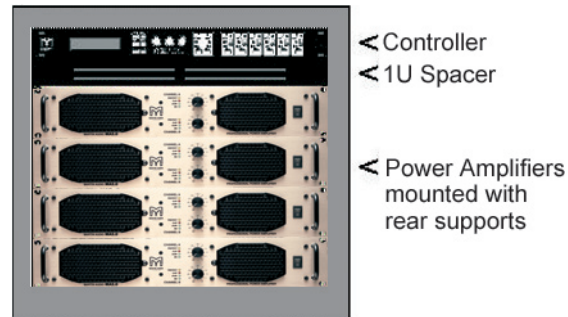

Always leave a 1U space between power amplifiers and controllers. Although most modern amplifiers don't radiate significant fields it's better to play safe and keep the system quiet. The spare space may prove useful when last minute controller additions are required for, say, extra audience fills. Rear supports are recommended. Check the manufacturer's application notes for details.

2.7 General system reminders

- 1) Where possible, use the same model system controller and power amplifier for a particular Wavefront product. This avoids confusion caused by different controller topologies or by power amplifiers with different voltage gains for the same output specs.
- 2) It is common practise to use mixing console matrix outputs as loudspeaker section controls. Whilst this is fine for creating a bass submix which can easily be judged from the mix position, it can be fraught with danger if used for Longthrow loudspeaker sections which may only be audible by touring the site on a bicycle! Trim outfield sections during listening tests with a colleague via walkie talkie, using the relevant controller input gains.

If the console matrix is the only solution available, try to pre-calibrate the matrix output levels controls to their 0dB (nominal) position initially. These settings will be easier to get back to and will avoid embarrassing level setting mistakes during the show - particularly if the system is being used by guest operators who may not be familiar with your particular matrix allocations.
- 3) And again, trim levels within clusters (eg inners vs outers) using the amplifier level controls to ensure limiter tracking.

2.8 Coverage

W8CT and W8CMs are designed to be flown in vertical line arrays to provide a combination of W8C-compatible 55° horizontal coverage with tight vertical control.

The vertical coverage of a single W8CT is approximately 7.5° in the upper midrange. When dead-hung, as illustrated below, the vertical coverage narrows with increasing cluster height following the classic law for multi-element line arrays.

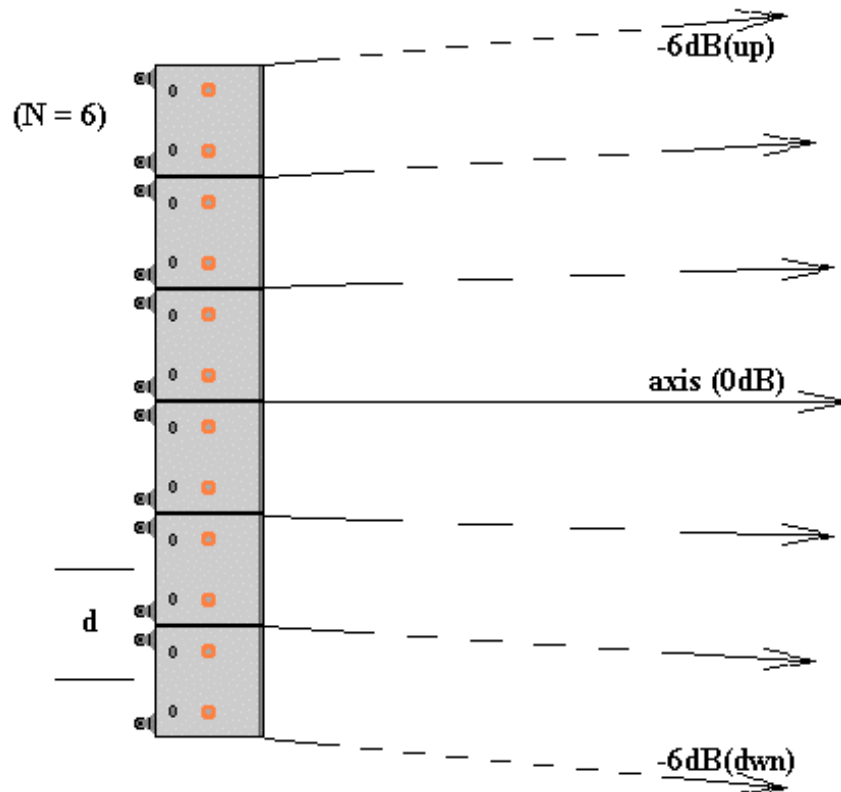

$$\text{Main coverage angle} = 2 \times \arcsin \left(\frac{0.61\lambda}{Nd} \right)$$

(between -6dB points
either side of axis)

where λ = the sound wavelength in meters = $\frac{340^*}{\text{Frequency (Hz)}}$
 N = the number of W8CTs/CMs high
 d = the centre-to-centre spacing (= 0.799m if vertically tightpacked)

* = speed of sound (m/s). Varies with temp. (see [Section 2a](#))
 Arcsin = "the angle whose sin is..."

(Note that Nd works out to be the total height of the column in meters)

Straight column gain and coverage

The following table shows typical Longthrow high-mid/high gain (wrt a single Wavefront W8C) plus the mid and high frequency vertical coverage provided by various straight vertical line arrays.

W8CTs in	high-mid/high gain (wrt single W8C)	vertical coverage (-6dB points)	
		high-mid	high
1 (single row)	9.5dB	7.42°	3.70°
2 (double row)	16dB	3.72°	1.86°
4	22dB	1.86°	0.93°
6	25dB	1.24°	0.62°
8	28dB	0.93°	0.46°
10	30dB	0.74°	0.37°

The above means that, for practical sound reinforcement uses, a long straight column's mid and high frequency coverage must be regarded as being cylindrical in nature. Low-mid vertical coverage will widen in the farfield depending on the height of the column but users should be guided by the following coverage shape to ensure consistent high frequency coverage.

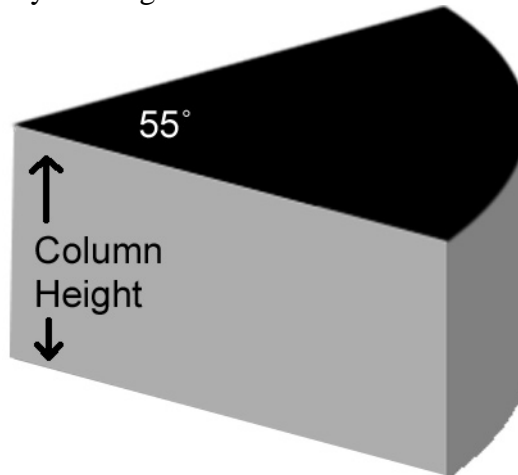

Straight W8CT column mid/hf coverage = 55° (horizontal) x the column height

A long, straight Wavefront Longthrow column will cover vast flat outdoor areas if you aim the column axis towards the rear of the audience. Remarkable results can be obtained indoors using continuous columns running from stage level to the maximum seating height.



Unfortunately, continuous vertical columns are rarely visually acceptable - particularly where the audience wraps around a thrust stage and sight lines are critical. In such cases, shorter Longthrow columns may be flown in combination with Wavefront W8C midfields and downfills.

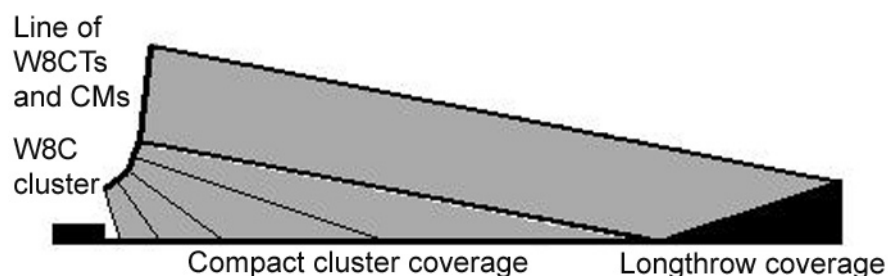

Martin Audio/M.A.N. Flying System overview

Flown clusters are recommended for very high power music systems covering large venues to ensure adequate coverage without excessive levels at the front of the venue.

Wavefront series products are fitted with MAN load-certified flying points and are designed to comply with the 12:1 safety factor specified by the German VBG70 standard when used with compatible 12:1 flying systems.

MAN Transformer or Installer/Tourer flying systems allow columns of loudspeakers to be assembled by attaching individual loudspeakers to vertically daisy-chained D-rings using keyhole cabinet fittings - hence the tendency to base flown designs in this applications guide on multiple columns. The beauty of the MAN system is that each cabinet in a system supports only its own weight.

Each pair of vertical chains is attached to a single-width, centrally pivoted sub-bar which, in turn, is attached to a two-way, centrally pivoted flying bar so that the system “finds its own level”, if accidentally hoisted asymmetrically, avoiding undue stresses and strains. **Please note that all components must have a 12:1 safety factor.**

Vertical splay angles are determined by intercabinet chain lengths whilst the overall column tilt is determined by the length of the chains between the upper cabinet and the sub-bar. Vertical columns are splayed by tensioning a ratchet strap threaded through the sub-bar and all of the cabinet back plates. Cabinets may be fitted with rear hinge back plates to allow removable hinges to be slotted in place. These hinge assemblies provide a more rigid rear cabinet alignment.

For further information please refer to the Martin Audio Wavefront 8 Flying System User Guide.

IMPORTANT NOTES!

Rigging should not be undertaken by untrained or unqualified personnel. Suitable rigging training sessions may be arranged by calling Martin Audio Ltd on +44 (0)1494 535312.

Flown systems examples

Wavefront cluster examples are included in this manual to illustrate recommended loudspeaker combinations and splay angles only. Note that very large clusters - particularly those including Wavefront Longthrow elements - may need to be flown in multiple layers to maintain the 12:1 safety factor of the standard Martin Audio Wavefront 8 Flying System.

Safety reminder

Two female "keyhole" stud plates are fitted to each side of Wavefront W8C and W8CT cabinets to allow cabinets to be flown up-side-down for certain applications. The upper keyhole is the only one ever used - whatever the configuration.

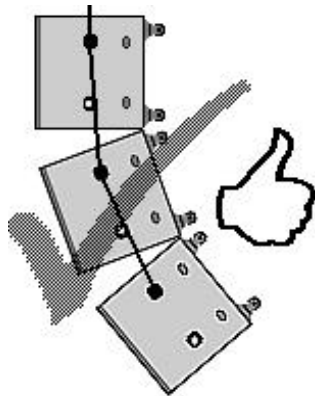

OK

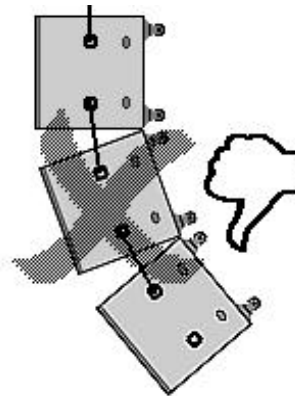

No, No, No!!!

- i) NEVER suspend one cabinet from the lower flying point of the cabinet above.
- ii) NEVER suspend standard cabinets horizontally.

2.9 Further examples

Wavefront Longthrow columns may be horizontally arrayed for wide coverage:

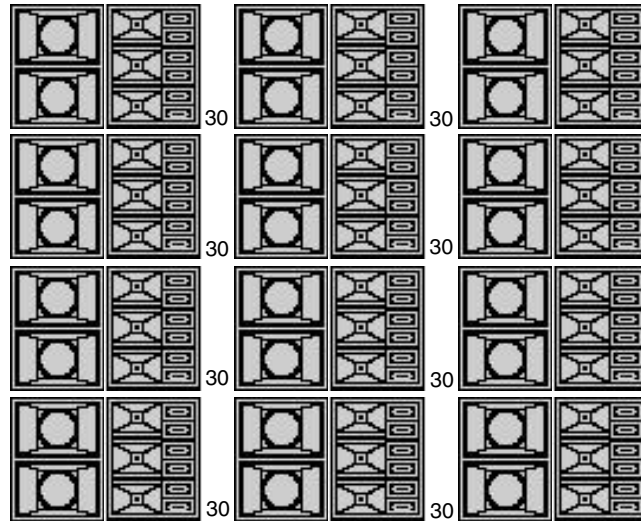

(left & right clusters will be mirror image)

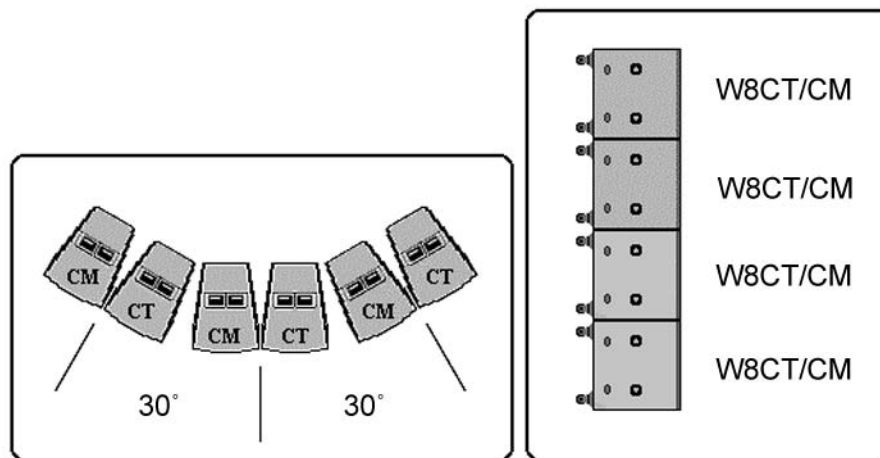

High-mid/high horizontal coverage would be

$$\begin{aligned}
 & 1/2 \text{ left W8CT} + 30^\circ + 30^\circ + 1/2 \text{ right W8CT} \\
 & = \text{one W8CT} + 30^\circ + 30^\circ \\
 & = 55^\circ + 60^\circ \\
 & = 115^\circ.
 \end{aligned}$$

2.9.1 Flying with W8CS'

Wavefront Longthrow columns may be flown with Wavefront W8CS' ([Section 3](#)). The W8CS' may be configured as fullbass systems - to leave the floor free for camera tracks, for example - or as a mid-bass section to augment floor-stacked WSXs where a large, standing audience is expected forward of the mix position.

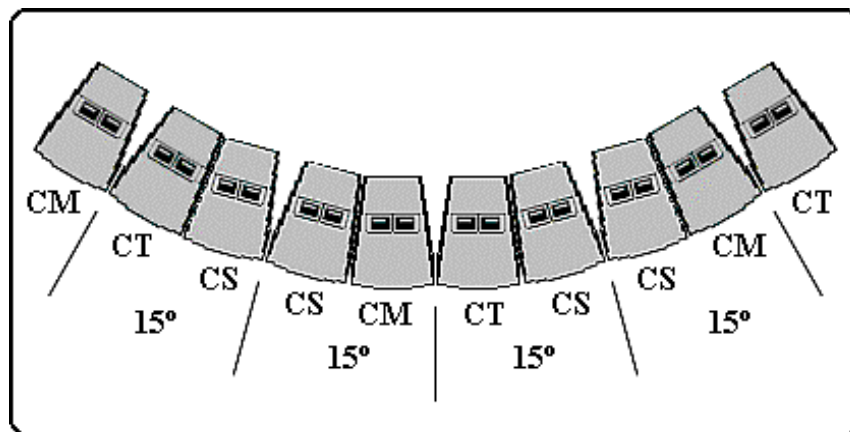
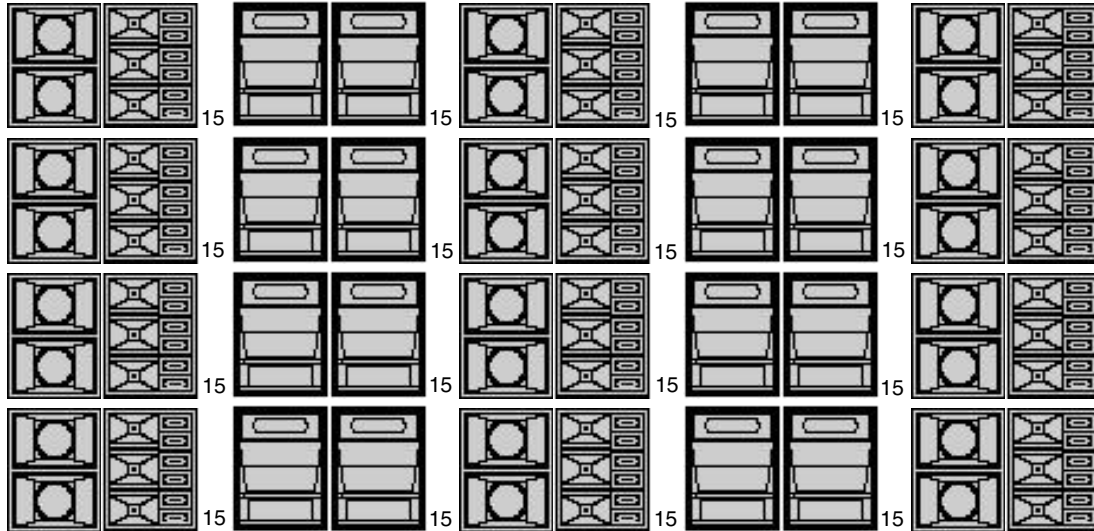

Reminder!

Splay angles are always quoted axis-to-axis - not between cabinet sides!

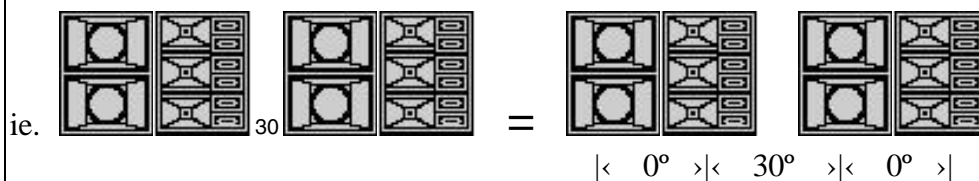

As with W8Cs, the single-box horizontal coverage is 55°. Horizontal splay angles of 25-35° between axes will provide coherent polar response summations resulting in smooth coverage with consistent tonal characteristics.

2.9.2 Flying with W8Cs

Wavefront Longthrow columns may be flown with Wavefront Compact W8C midfield and downfill sections.

The following example shows a wide coverage Longthrow system with W8C midfield and downfill sections. Note that a double (vertically tightpacked) row of W8Cs has been flown as the midfield section. Vertically tightpacking these W8Cs extends their forward throw to help smooth the transition from Wavefront Longthrow to Wavefront W8C. The vertical splay angle between the main Longthrow column and the double W8C midfield section is kept small to avoid vertical coverage gaps.

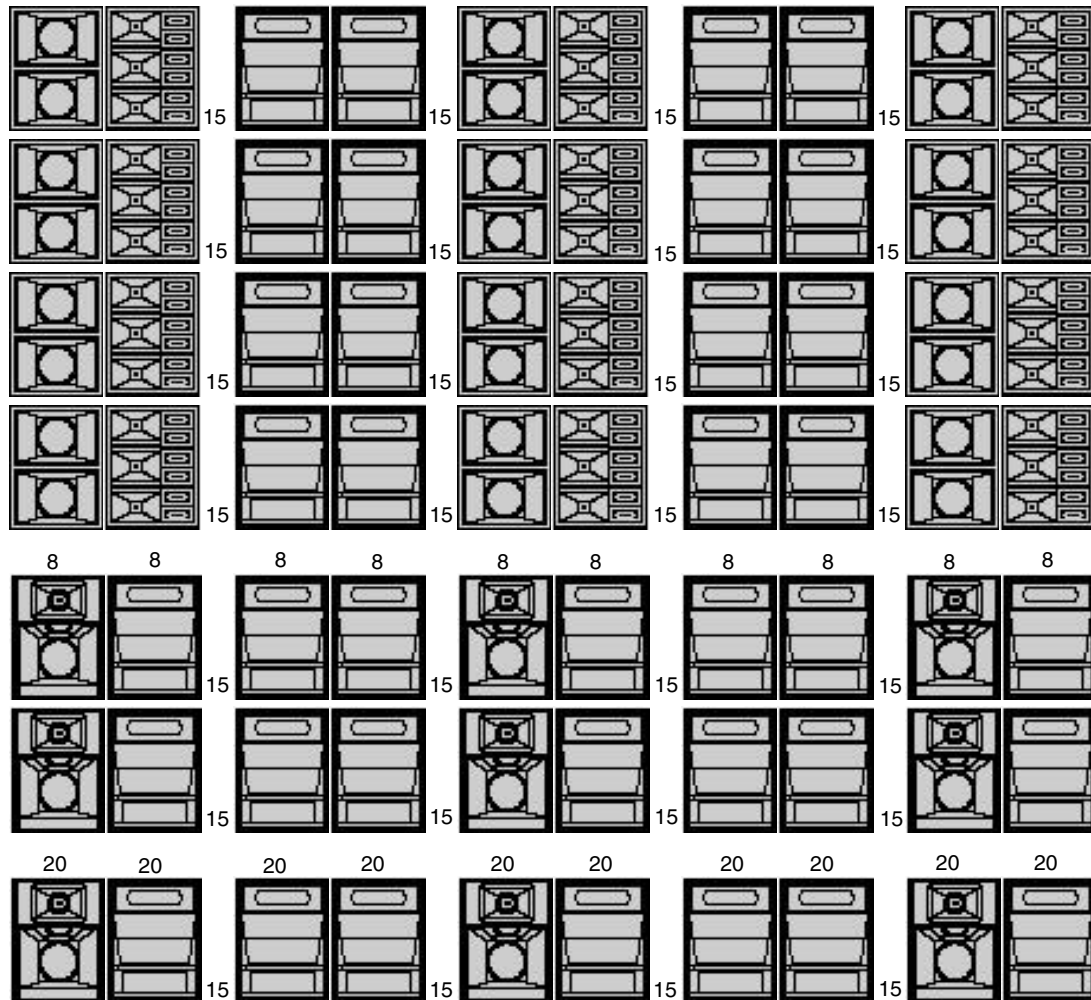

Note that the Longthrow system's output is considerably greater than the Compact's for the same input voltage so some level tailoring tends to be required to provide smooth coverage with distance.

FAQ: *Why do you use powerful Longthrow and tight-packed sections and then turn them down?*

A: *The tight vertical coverage of the Longthrow and tight-pack sections allows us to concentrate high quality sound onto the audience without exciting roof resonances. They help maintain excellent direct-to-reverb ratios.*

A typical arena gain set-up may be as follows:

Main Longthrow section	-12dB to -6dB
Double W8C midfield section	-6dB to 0dB
W8C downfills	-4dB to 0dB

2.9.3 Adding Longthrow elements to W8C/W8CS clusters

Wavefront Longthrow elements may be added to conventional W8C/CS clusters for larger venues, to improve overall sound projection to, for example, upper rear seats.

Note that when just a few Wavefront Longthrow elements are used to supplement a large W8C system, high-mid/high W8CTs may be used without low-mid W8CMs as low-mid energy is provided by adjacent W8C low-mid sections.

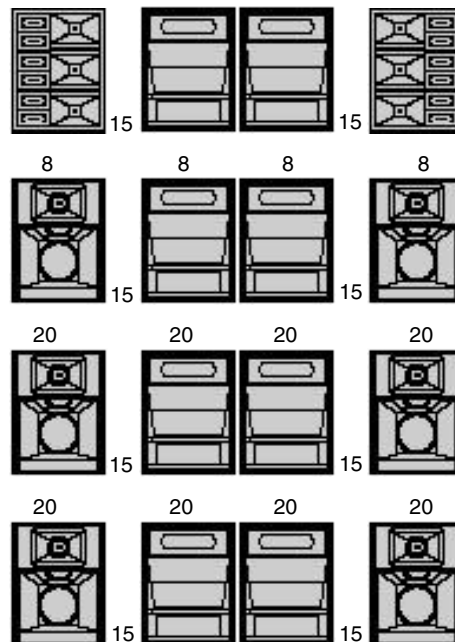
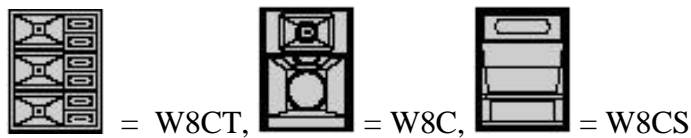

A simplified maximum **horizontal** coverage calculation is:

$$27.5^\circ (\text{left } \frac{1}{2} \text{ W8C/W8CT}) + 15^\circ + 15^\circ + 27.5^\circ (\text{right } \frac{1}{2} \text{ W8C/W8CT}) = \mathbf{85^\circ}$$

A simplified maximum **vertical** coverage calculation is:

$$3.75^\circ (\text{top } \frac{1}{2} \text{ W8CT}) + 8^\circ + 20^\circ + 20^\circ + 15^\circ (\text{bottom } \frac{1}{2} \text{ W8C}) = \mathbf{66.75^\circ}$$

Climatic effects on sound propagation

2a.1 Introduction

When working in large venues or outdoors we should always remember that sound propagates through air and is affected by air temperature, humidity and wind.

The most audible of these effects is wind as it can vary dramatically in less than a second causing rapidly swept filter effects that change middle and high frequency content into incoherent noise.

Air temperature can change suddenly with very audible effects (eg when backstage doors are opened during sound checks, venue doors are opened near the end of a show in winter or cold air displaces the warm air trapped in a stadium during a clear summer evening). Although quite rare, rapid air temperature changes can cause sudden changes in propagation direction and major coverage problems for a few fretful minutes before clearing. These sudden coverage changes often trigger sound system investigations as they tend to sound like mid or high frequency component failures or tripped amplifiers.

Humidity tends to change slowly with time and affects the higher frequencies. This slow change can be missed as our ear-brain system tends to compensate for subtle high frequency losses. If the relative humidity changes from, say, 25% at the beginning of a hot afternoon's sound check to 40% as the weather turns sultry, we may not notice the gradual 6dB increase in high frequency at the back of the field (3dB at the mix position) until the guest engineer arrives, having walked the field with a clean* pair of ears, and wants to change everything.

*Be aware that the human ear discharges more wax in humid conditions and this will tend to negate the improved high frequency propagation.

Although it is not possible to control the climate outdoors at the moment, a knowledge of its various effects on sound system performance will allow good system designers to minimise problems as follows:

- 1) Avoid trying to cover large outdoor areas with multiple, horizontally parallel arrays. Keep mid & high frequency sections closely coupled at their optimum horizontal splay angles to minimise audible combing effects with crosswinds.
- 2) Avoid high, heavily tilted point source clusters as their propagation can be refracted by temperature gradients or reflected by strong air layers causing major coverage problems. Use large, continuous vertical columns (from stage height to crane hook) to propagate sound almost parallel to the ground.
- 3) Design for at least 5° excess vertical and horizontal coverage to allow for propagation shifts. If you don't have the extra equipment for this contingency, be prepared to retrim cluster tilts until the doors are about to open.
- 4) Where possible, take regular breaks outside the venue to avoid adapting to humidity changes. If there is no time for breaks, ask trusted crew members for

their opinions or compare the system's high frequency sound quality with a pair of high quality mix position monitors delayed back to the PA. The PA should sound warmer and more punchy but should never sound brighter than good monitors unless the man with the cheque book wants it that way.

- 5) Always get trusted sound crew members to walk the field during the show. Their reports will be telling you more about climate changes than your system setup so don't be surprised if they ask for subsection level changes and eq adjustments. Major changes can occur when:
- i. the audience floods in (temperature gradients get disturbed and humidity can rise)
 - ii. around sunset (temperature and local wind changes)

2a.2 Wind effects

Side winds

Gusting side winds can dramatically effect mid and high frequency sound by changing the propagation direction (and, therefore, the way adjacent radiators interact) as follows:

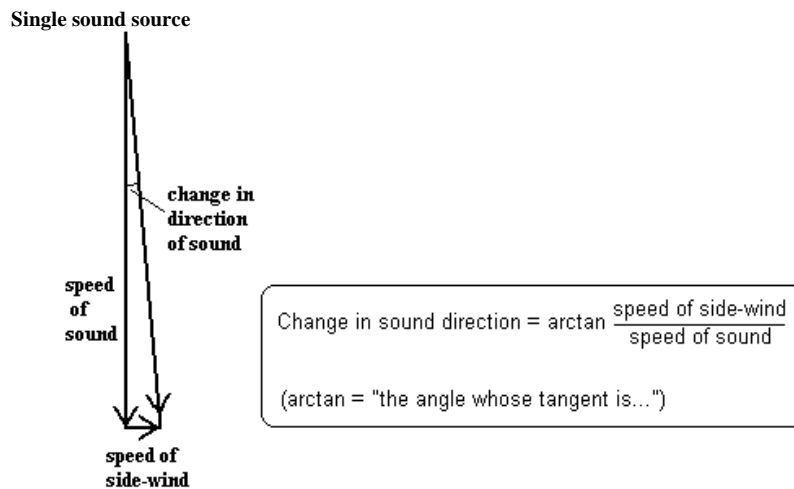

For example a 50km per hour (31 mph) side gust = approx 13.9m/s.
The temporary change in direction during the gust = $\arctan 13.9/340$
= approx $\arctan 0.041$ = approx 2.3°

This may seem trivial until you realise that this sudden 2.3° change will shift a poorly arrayed system's polar pattern undulations about 2m to right at a typical outdoor mix position. Easily enough to swap high-mid and high frequency peaks and troughs several times in just a few seconds - an effect that went out of fashion in the 60s!

Variable combing (phasing) caused by wind effects should be minimised by avoiding widely spaced, parallel high frequency sections carrying the same signals.

Spaced, parallel loudspeakers will comb (add or subtract their outputs) depending on their distance or time offset from us (see [Section 4.10](#)). A 150mm/0.5ms offset at the listening position will cause nulls at 1KHz, 3KHz, 5KHz, 7KHz, 9KHz, 11KHz etc but we wouldn't be aware of the combing under casual listening conditions because we are used to listening to natural sounds in the presence of multiple arrivals (echoes) and our ear-brain system adapts to them. We don't adapt to *varying* comb structures though, especially in the horizontal plane, as our horizontally spaced ears act as a sensitive interferometer.

Martin Audio Wavefront Longthrow horns are stacked vertically and adjacent W8CTs may be flown in mirror image and splayed 30-40° (for coherent arraying) to minimise high frequency combing in breezy outdoor conditions. Widely spaced, parallel columns – carrying the same signal - should be avoided.

Where budgets allow, mono centre clusters should be used for lead vocals and instrumentals. Large ensembles (such as large string sections or large choirs) should be divided into multiple subgroups which are sent to separate clusters.

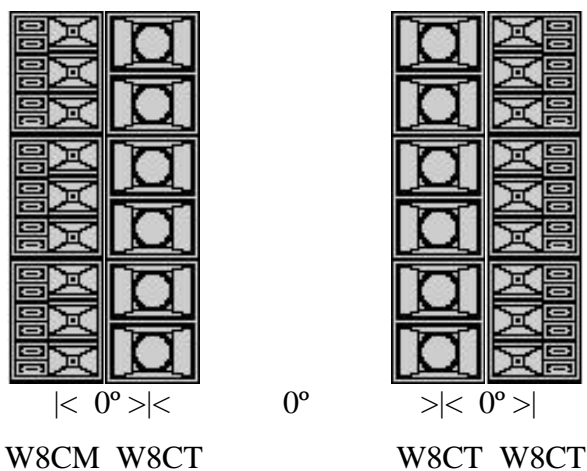

Spaced, parallel columns – **Bad in windy conditions**

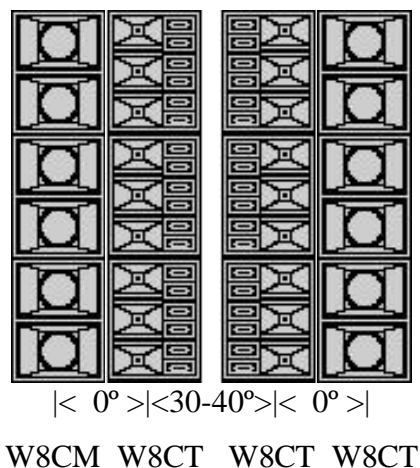

Splayed, tightly packed columns – **Better in windy conditions**

Wind gradient

Air movement is slowed by friction so wind is usually lighter near the ground than it is higher up. Ground level wind speeds can vary from over 90% of the main wind speed in the daytime, when the air is being mixed by being warmed by the ground, to under 30% at night, when air - cooled by the ground - loses buoyancy.

This varying wind speed with height is called the wind gradient.

A wind gradient associated with wind blowing towards a loudspeaker will "slow" its vertical wavefront differentially. The vertical wavefront will be slowed less near the ground and its sound path will veer upwards.

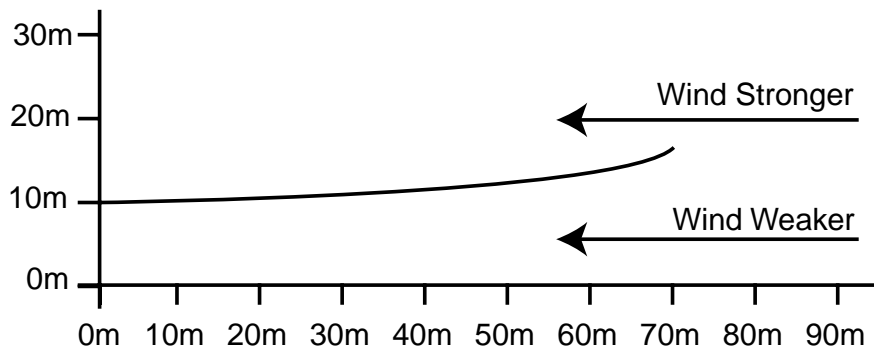

Sound path tilting upwards outdoors due to wind blowing towards loudspeakers

Conversely, a wind gradient associated with wind blowing from behind a loudspeaker system will "speed up" its vertical wavefront differentially. The vertical wavefront will be speeded up less near the ground and its sound path will veer downwards.

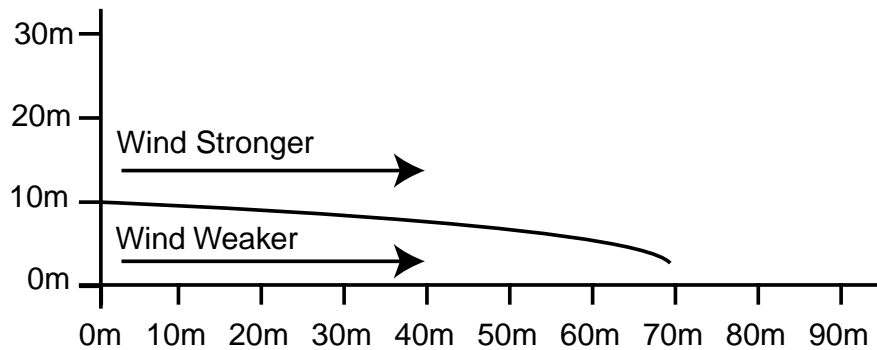

Sound path tilting downwards outdoors due to wind blowing away from loudspeakers

Local winds

Air absorbs very little heat from the sun's rays. It is indirectly heated by contact with warm surfaces. It also relies on contact with cooling surfaces to lose heat.

A local, anabatic wind can be set up by air rising up a slope warmed by the morning sun.

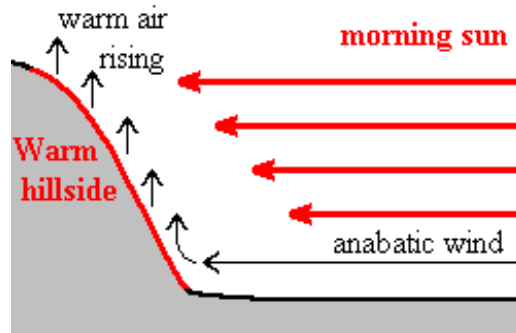

The same slope may cool the air at night causing it to flow down hill to form a katabatic wind. To maintain coverage, loudspeaker cluster tilts may need to be readjusted between morning orchestral rehearsals for a major outdoor event and the actual show.

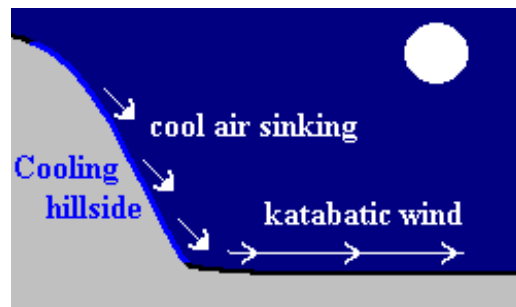

Gusts and squalls

On a fair day when the ground is warm and clouds are forming and being moved by a very light breeze, local winds may vary in direction and strength as illustrated below.

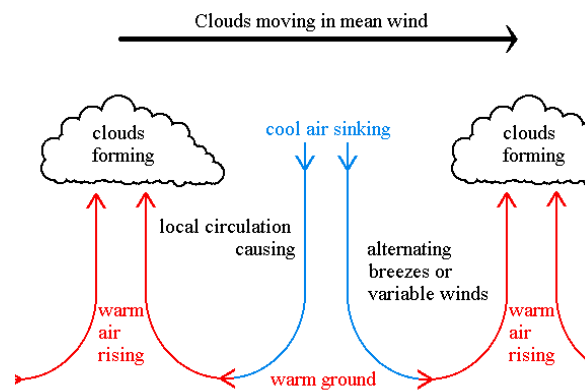

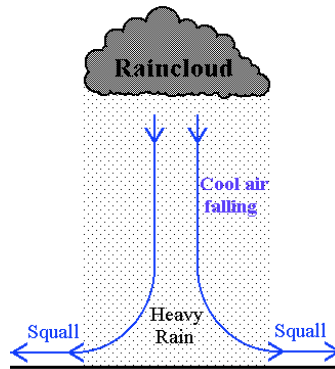

Local winds may be even more erratic in showery weather. Dramatic down-drafts of cold air may occur causing local squalls.

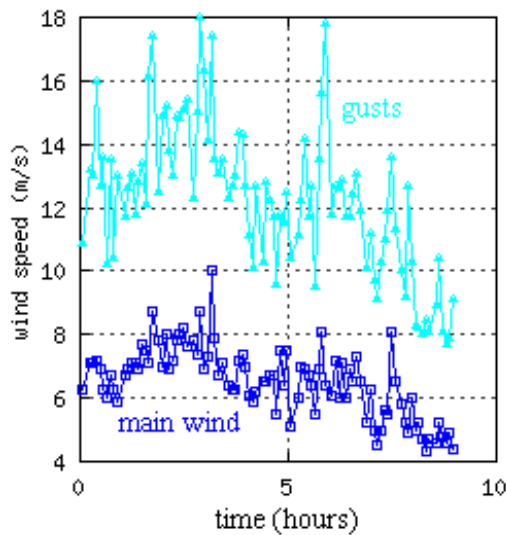

Graph showing main wind speed (dark colour) and gusts (light colour) over several hours

The above main wind and gust plot shows that gusts can be more erratic in nature and several times stronger than the main wind. Their effects will be far more audible than a steady wind.

Anti-phasing eq

It may be advisable to roll off the system's high frequency response during gusts and squalls as a decreasing hf response sounds more natural than the incoherent swishing noise associated with phasing. A single pole (6dB per octave) high cut filter with a variable knee control down to 8KHz works well.

2a.3 Temperature effects

The speed of sound varies with air temperature:

$$\text{Speed of sound} = \sqrt{\frac{\gamma RT}{M}} = 20.055 \sqrt{273.16 + ^\circ\text{C}} \text{ meter/second}$$

Where γ = specific heat ratio = 1.402

R = gas constant = 8.314 (joules/mole K)

T = temperature, K

M = 0.02898 (kg/mole)

This means that the speed of sound can vary from 331.5m/s to 354.9m/s between 0°C and +40°C.

Temperature Gradient

As mentioned in [Section 2a.2](#), air is a poor heat conductor and relies on its contact with surfaces to heat up and cool down.

On a clear, warm, sunny day the ground will warm low level air and the atmosphere will heat up, by convection, from bottom to top. Warm air cannot rise to the top of the atmosphere because air pressure drops with height and air temperature falls as the pressure falls.

Sound will travel faster near the ground and slower higher up causing its path to be tilted upwards.

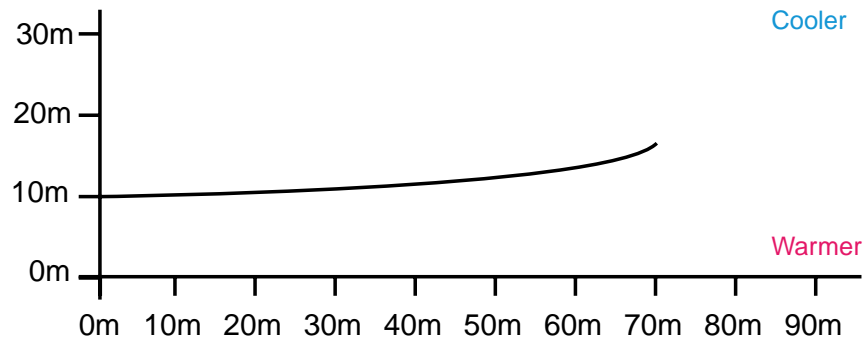

Sound path tilting upwards outdoors due to normal temperature decrease with height

If the sky remains clear after sunset, the ground will cool and draw heat from the air in contact with it. Air nearest the ground may get cooler than the air above it. In the absence of wind, this cool air may stay near the ground on a still night.

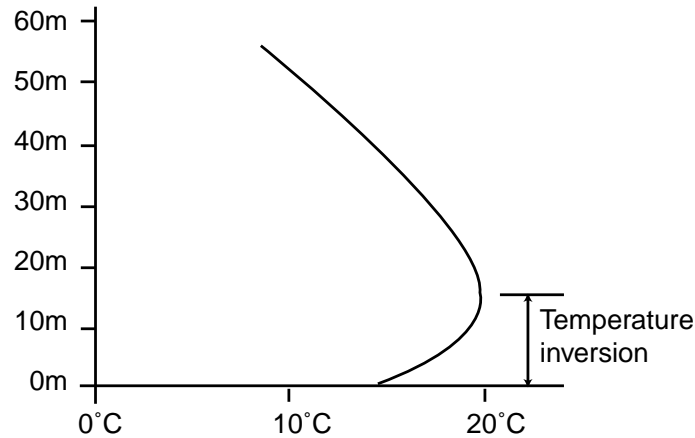

The same "inverse temperature gradient" can form above ice rinks and in most indoor venues. Sound will now travel slower near the ground and faster higher up causing its path to be tilted downwards.

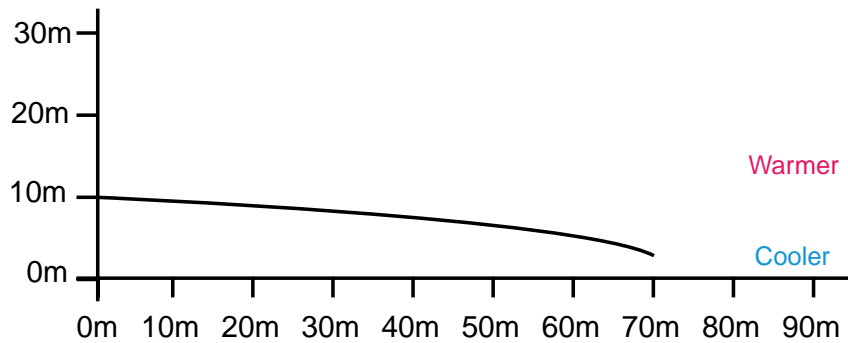

Sound path tilting down indoors due to high level heating or low level cooling (eg. ice rink) or outdoors due to cooling ground

2a.4 Relative humidity effects

Air absorption is quoted in dB/m and occurs over and above the usual sound pressure level changes caused by an expanding wavefront quoted in dB/doubling of distance.

Air absorption changes with relative humidity and temperature but these changes are complex - particularly where the humidity is low and the temperature varies a lot.

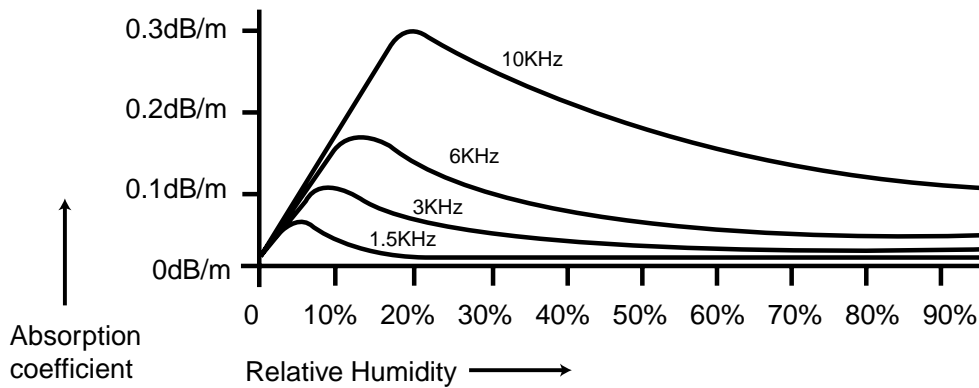

In this example, high-mid and high frequency air absorption characteristics are quite complex at low relative humidity. Mid frequency absorption increases with increasing humidity, reaches maximum attenuation at about 5% RH and then starts to drop again. High-mid frequency absorption increases with increasing humidity, reaches maximum attenuation between 5 and 15% RH and then starts to drop again. High frequency absorption increases with increasing humidity, reaches maximum attenuation between 15 and 20% RH and then starts to drop again.

At the higher relative humidity (above 20% RH) found in temperate latitudes, absorption generally decreases with increasing relative humidity. This means that high frequency sound propagation improves as the relative humidity rises ... but this is not always obvious in warmer weather as our ears produce more secretions when we perspire.

Note that, even at high relative humidity, we will still lose 10dB at 10KHz over 100m. Martin Audio Wavefront Longthrow systems provide the extra high-mid and high frequency headroom to cope with this air absorption.

Humidity changes can be a problem indoors too. On rainy days, damp audiences in large venues can cause temporary humidity increases that can make a well sound-checked system sound too harsh and fizzy. Be prepared to back off any mid and high frequency compensation until the venue's air conditioning has caught up.

Longthrow systems should be corrected with caution and distant audience areas rechecked at regular intervals during large events.

Wavefront Compact Series

Applications Guide

Section 3

Wavefront W8CS Flown Subwoofer



The Martin Experience

All material © 2007. Martin Audio Ltd. Subject to change without notice.

Section 3

Wavefront W8CS Flown Subwoofer

Contents

- [3.1](#) **Introduction**
- [3.2](#) **Specifications**
- [3.3](#) **Pin-outs and cabling**
- [3.4](#) **System patching**
- [3.5](#) **DX1 Loudspeaker Management System**
- [3.6](#) **Power amplifier recommendations**
- [3.6.1](#) **Martin Audio MA4.2 Power Amplifier Overview**
- [3.7](#) **Adding W8CS' to flown W8C systems**

Wavefront W8CS Flown Subwoofer



3.1 Introduction

The Martin Audio Wavefront W8CS Flown Subwoofer comprises a special 15" high excursion driver coupled to an efficient mid-bass horn with a sub-bass port. This unique combination gives the W8CS the characteristic punch of a horn-loaded system with the low frequency bass extension of a reflex enclosure.

The W8CS is a compact, light weight system in a trapezoidal cabinet. It has the same footprint as the popular W8C ([Section 1](#)) and has been engineered to extend the Wavefront Compact W8C's performance to below 45Hz.

W8CS' may either be used as full bass subwoofers (up to 120Hz) or may be flown as mid-bass sections (60-160Hz) to complement floor standing WSXs.

Like all flown Wavefront products, W8CS' are fitted with MAN load-certified flying points and are designed to comply with the 12:1 safety factor specified by the German VBG70 standard when used with the compatible 12:1 flying systems. One important advantage of the MAN flying system is that inter-cabinet connections place a minimal load on the cabinets and, being external, can be load certified and inspected independently.

3.2 Specifications

Type:	Compact folded bass horn, port assisted
Frequency response:	45-200Hz +/- 3dB
Low frequency limit:	-10dB @ 35Hz
Driver:	1 x 15" (380mm) long excursion
Rated Power:	800W into 8 ohms, 3200W peak
Sensitivity:	105dB/W

Maximum SPL:	132dB continuous, 138dB peak
Impedance:	8 ohms nominal
Connectors:	2 x Neutrik NL8
Cabinet construction:	Birch Ply
Cabinet finish:	Slate textured paint
Protective grille:	Perforated steel
Grille finish:	Grey paint
Dimensions (inc wheels):	(W) 562mm x (H) 799mm x (D) 925mm (W) 22.1ins x (H) 31.5ins x (D) 36.4ins
Flown weight:	61kg (134lb). Lid 4kg (9lb) extra

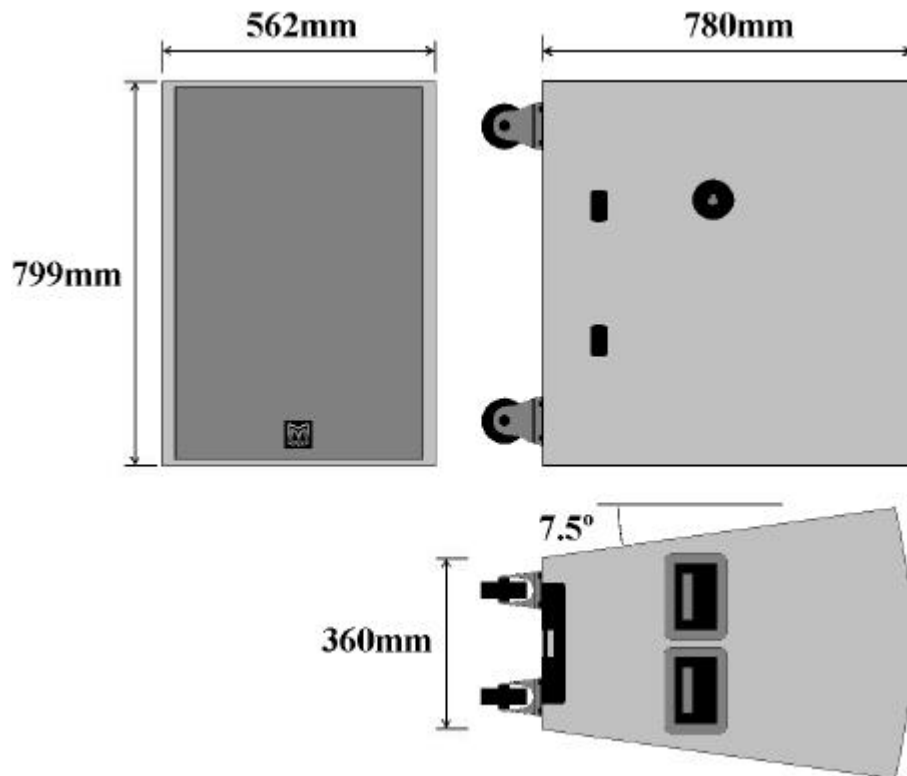

Before rigging, note colour coding!

**W8C has 2 black points per side
W8CS has 1 black point per side**

**W8CT has 2 orange points per side
W8CM has 1 orange point per side**

3.3 Pin-outs and cabling

W8CS	
NL8	W8CS
-1	Driver -
+1	Driver +
-2	Driver -
+2	Driver +
-3	n/c
+3	n/c
-4	n/c
+4	n/c

(See [Section 1.3](#) for connector pin-out drawing)

3.3.1 Cable and panel connector part numbers

Please note the following part numbers when ordering loudspeaker connectors to make up cables and patch panels

Neutrik NL connectors	
NL8FC	8 pole cable (female)
NL8MPR	8 pole panel (male)
NL8MM	8 pole inline coupler (male-male)

Connectors should be kept in good, clean, uncorroded condition to ensure full, undistorted loudspeaker performance. Corroded or damaged pins and sockets can cause severe distortion or loss of signal.

3.3.2 Recommended loudspeaker cable

Although only 4-core cable is required for W8CS', many users will find it convenient to standardise on 8-core NL8 cables to avoid confusion when using other loudspeakers in the Wavefront range.



Cable run vs copper core cross sectional area

	Single W8CS	Two W8CS' paralleled at the cluster.
Up to 50m	2.5mm ²	6mm ² (or 2 x 2.5mm ² cores in parallel)
Up to 100m	6mm ²	10mm ² (or 2 x 6mm ² cores in parallel)

Q. Why the odd sizes?

A. Loudspeaker cables are available in a limited range of standard copper core sizes - ie. 1.5mm², 2.5mm², 4mm², 6mm², 10mm² and 35mm².

3.4 System patching

Refer to [Section 1.4](#) and [Section 2.4](#) for general Wavefront patching suggestions and examples.

Bass sub-mix operation

Many mix operators prefer to create a separate sub-mix for bass/mid-bass sections. This is good practice as it helps provide main system headroom for those all-important vocals and solos whilst allowing for larger-than-life percussion and bass instrument mixes without intermodulation and distortion.

This configuration can easily be programmed into the Martin Audio DX1 Loudspeaker Management System. The following illustrates a DX1 set up to control an active (3-way) Wavefront W8C system with W8CS' (configured as a flown mid-bass section) augmenting floor-stacked WSXs.

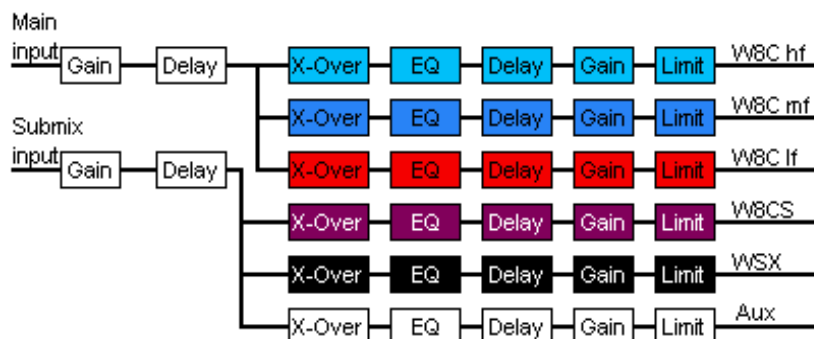

Flying W8CS' as a mid-bass section eliminates the problem of mid-bass absorption experienced with densely packed standing crowds.

3.5 DX1 Loudspeaker Management System

Refer to [Section 1.5](#) for general information on the Martin Audio DX1 Loudspeaker Management System including configuration examples.

3.5.1 DX1 Output Gain and Limiter settings for W8CS'

Standardising on one good model of power amplifier (preferably the [Martin Audio MA4.2](#)) and correctly set-up controller (preferably the [Martin Audio DX1](#)) will provide the most dynamic system performance and protection whilst simplifying design and reducing spares inventories. (See [Section 1.5](#) and [DX1 Speaker Management System User's Guide](#) for further details)

Gain settings

The following initial DX1 output gain settings will enable full system performance to be obtained whilst keeping the console and drive system noise floors inaudible and avoiding amplifier slew-rate limiting:

W8CS - assuming 800Wcont - 1600Wpk into 8Ω power amplifiers:				
Best-fit Amplifier Example	Amplifier Sensitivity		Amplifier Gain	Initial DX1 Output <u>GAIN</u>
	dBu	Vrms	dB	dB
Crown MA5002VZ (0.775v)	-2	0.62	42	-9
Martin MA4.2** (41dB)	-1	0.69	41	-8
Crest CA18 (x115)	-1	0.69	41	-8
Crown MA3600VZ (0.775v)	-1	0.69	41	-8
	0	0.77	40	-7
	+1	0.87	39	-6
	+2	0.98	38	-5
	+3	1.09	37	-4
QSC PL236/PL236A (36dB)	+4	1.23	36	-3
	+5	1.38	35	-2
	+6	1.55	34	-1
	+7	1.73	33	0
Martin MA4.2** (32dB)	+8	1.95	32	+1
Crest 8001 (x40)	+8	1.95	32	+1
Crest 9001 (x40)	+8	1.95	32	+1
QSC PL236A (32dB)	+8	1.95	32	+1
	+9	2.18	31	+2
	+10	2.45	30	+3
	+11	2.75	29	+4
	+12	3.08	28	+5
	+13	3.46	27	+6
Crown MA3600VZ (26dB)	+14	3.88	26	+7
Crown MA5002VZ (26dB)	+14	3.88	26	+7
QSC PL236A (26dB)	+14	3.88	26	+7

**** Set Martin Audio MA4.2 rear MLS switch to 0dB to match peak output of unregulated power amplifiers.**

Cluster balance (eg farfield-to-midfield or inner-to-outer) should be adjusted **at the power amplifier controls** to maintain limiter tracking. See [Section 3.7](#).

Balancing the system using gain controls in the signal path *before* the power amplifiers is not recommended as it will cause the higher signal level upper rows of a big cluster to start limiting before the lower signal levels downfills causing tonal changes at the mix position.

Limiter settings

The Rated Power specification in [Section 3.1](#) indicates the maximum long-term power dissipation that can be tolerated before driver ageing or damage occurs through overheating or over-excursion.

When choosing power amplifiers, do not be tempted to exceed the 800W into 8Ω power rating unless the amplifier's power rails are well regulated (see [Section 3.6](#)) - even with properly set controllers in place. Although Martin Audio drivers are mechanically designed to survive normal road use and the occasional operator error, overpowered or bridged amplifiers can cause over-excursions that stress and age drivers. The best way to get the clean, relaxed sound of an overpowered amplifier is to choose an amplifier with plenty of current reserve - ie an amplifier with good 2Ω specification - and avoid running more than two cabinets in parallel.

To ensure transparent limiter operation without obvious distortion or pumping, the DX1 limiter attack and release times are factory preset to be inversely proportional to the subwoofer's high pass frequency as follows:

High pass filter range	Attack time	Release time
>31Hz	45mS	720mS
31Hz - 63Hz	16mS	256mS
(63Hz high pass may be used when W8CS crossing in as a mid-bass)		

These attack times allow the power amplifiers to clip momentarily but not for long enough to be obvious to listeners or cause driver overheating. It is quite normal to see amplifier clip indicators on the odd programme peak but continuous clipping would indicate a cable short circuit, wrong controller settings, excessive power amplifier gain or low mains voltage.

The following initial DX1 output limiter settings will avoid voice coil overheating and minimise amplifier clipping for high quality, trouble free operation.

W8CS - assuming 800Wcont - 1600Wpk into 8Ω power amplifiers:

Best-fit Amplifier Example	Amplifier Sensitivity dBu	Amplifier Vrms	Amplifier Gain dB	Recommended DX1 <u>LIMITER</u> Settings dBu
Crown MA5002VZ (0.775v)	-2	0.62	42	-3
<u>Martin MA4.2** (41dB)</u>	-1	0.69	41	-2
Crest CA18 (x115)	-1	0.69	41	-2
Crown MA3600VZ (0.775v)	-1	0.69	41	-2
	0	0.77	40	-1
	+1	0.87	39	0
	+2	0.98	38	+1
	+3	1.09	37	+2
QSC PL236/PL236A (36dB)	+4	1.23	36	+3
	+5	1.38	35	+4
	+6	1.55	34	+5
	+7	1.73	33	+6
<u>Martin MA4.2** (32dB)</u>	+8	1.95	32	+7
Crest 8001 (x40)	+8	1.95	32	+7
Crest 9001 (x40)	+8	1.95	32	+7
QSC PL236A (32dB)	+8	1.95	32	+7
	+9	2.18	31	+8
	+10	2.45	30	+9
	+11	2.75	29	+10
	+12	3.08	28	+11
	+13	3.46	27	+12
Crown MA3600VZ (26dB)	+14	3.88	26	+13
Crown MA5002VZ (26dB)	+14	3.88	26	+13
QSC PL236A (26dB)	+14	3.88	26	+13

**** Set Martin Audio MA4.2 rear MLS switch to 0dB to match peak output of unregulated power amplifiers.**



Use lower settings (or more subwoofers!) if your power amplifiers indicate clipping on more than just the odd peak. Excessive clipping may also be caused by inadequate power amplifier reserve or an inadequate mains supply. [See Section 3.6.](#)

3.6 Power amplifier recommendations

The Wavefront Compact Subwoofer has been designed and manufactured for very high performance but will not give that performance unless power amplifiers are chosen and used intelligently.

Power capability

W8CS' provide full performance when driven by professional power amplifiers capable of delivering undistorted output power into a range of loads as follows:

W8CS

800 W(AES) into 8 ohms
1,600 W(AES) into 4 ohms
and
3,200 W(AES) into 2 ohms

Please note:

Amplifiers with excessive output may damage voice-coils or age driver suspensions due to excessive heat dissipation and excursion.

A note about power amplifier output specifications

Most power amplifier manufacturers keep their costs down by using unregulated supply rails which sag under load. To allow for this sag, manufacturers set their rails high so that they still meet their quoted output into specified loads. These high rail voltages allow such power amplifiers to provide outputs 1.5 - 2 times their quoted power for short-term bursts. Martin Audio products will withstand this potential doubling of instantaneous power - ***with suitably set controller limiters*** - but further, long-term increases caused by over-sized amplifiers should be avoided.

Martin Audio MA series power amplifiers have regulated rails so it is quite permissible to use slightly overpowered models - ***with suitably set controller limiters*** - without risking uncontrolled power bursts. The MA series power amplifiers' regulated power rails also ensure maximum performance under the real-world concert conditions of less-than-optimum mains supplies and low impedance loads. See [Section 3.6.1](#) for further details.

Amplifier load tolerance

An efficient subwoofer system in live concert conditions can act as a surprisingly dynamic and complex load. Most modern touring power amplifiers claim 2 ohm capabilities but make sure your amplifier is also capable of driving reactive (ie inductive or capacitive) loads without prematurely clipping or developing output stage crossover distortion.

Power reserve

Most power amplifier specifications are based on bench measurements made using stable, high current mains supplies and well defined loads. Amplifiers sound best when they have plenty of current in reserve for percussive peaks and sustained bass notes.

- 1) Try to ensure that the mains supply stays within the amplifier manufacturer's specified range from no load to maximum load.

An electrical technician should check the mains supply vs demand using an accurate rms voltage meter.
- 2) If unfamiliar generators are being used the electrical technician should check the mains waveform (using a portable 'scope-meter) to make sure that it is sinusoidal and not crawling with spikes or interference.
- 3) Avoid driving too many W8CS' in parallel. I would suggest no more than two so that the power amplifier's 2 ohm spec is kept in reserve for musical peaks.
- 4) Avoid using power amplifiers in bridged mode. Most commercial power amplifiers are optimised for 2-channel operation. It is usually better to use the appropriate amplifier in 2-channel mode than to use an inadequate amplifier in bridged mode.

Power amplifier gain or level settings reminder

Gain switches

If you are lucky enough to have amplifiers with user gain switches, set them all to identical positions. A voltage gain in the range 23-33dB will provide a good balance of system headroom and noise (assuming professional audio equipment is in use FOH).

Level controls

The front panel level controls should be turned down (fully counter clockwise) until FOH-to-Amp rack lines have been checked and controllers have been set to suit the power amplifiers to be used (see [Section 3.5](#)). Music should be used to check that controllers are receiving and sending the appropriate signal bands and then each power amplifier level control advanced in sequence to check system operation and patching.

Assuming that controllers have been set as tabulated in [Section 3.5](#), power amplifier level controls should be set to full (fully clockwise) for loudspeaker sections requiring the strongest drive. Amplifiers driving nearer-field sections within the same cluster

may be backed off as required for smooth coverage. This process will ensure that the cluster coverage remains balanced during limiting.

Rack mounting

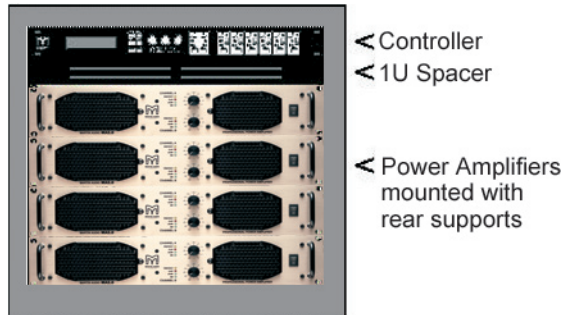

As with main W8C systems, always leave a 1U space between big subwoofer power amplifiers and controllers. Although most modern amplifiers don't radiate significant fields it's better to play safe and keep the system free from hum & buzz. Rear supports are recommended. Check the manufacturer's application notes for details.

3.6.1 Martin Audio MA4.2 Overview



Features

- Switch mode power supply
- Superior sonic performance
- Light weight
- Advanced protection circuits
- Efficient copper cooling system
- Minimum load switches (MLS™)

The MA4.2 power amplifier has been designed to combine reliability and high power output with sonic excellence. Utilising an advanced switch mode power supply, the MA4.2 is characterised by a very high power-to-weight ratio, in a lightweight, 2U package.

See [MA4.2 Power Amplifier User's Guide](#) for detailed operating instructions.

Cooling System

The Martin Audio MA4.2 amplifier runs very cool due to a special patented copper cooling system. The amplifier's bi-polar output devices are mounted directly onto a copper heat sink (copper conducts heat twice as efficiently as aluminium) and maximum heat dissipation is achieved by turbulent airflow over the heatsink's geometric fins.

The MA4.2 amplifier features two proportional speed cooling fans which take in air from the front of the amplifier and exhaust from the rear. A horizontal pressure chamber between the heatsink and the cooling fans ensures that there is little difference in the operating temperatures of each output device. In contrast, a conventional tunnel design can result in a temperature variance of up to 40° between output devices.

Switch Mode Power Supply

The MA4.2's switch mode power supply (SMPS) is the modern solution to the problems of size and weight. Switch mode power supplies are not new - they are found in computers and televisions. However, the demands of high power audio are very different to these applications. The MA4.2 overcomes the size and weight constraints of conventional power supplies whilst at the same time avoiding the pitfalls of typical switch mode designs.

The low output impedance of the SMPS means that rail voltages do not sag under heavy load conditions. Additionally, the rail capacitors are being recharged at a much faster rate than those in a conventional power supply. The result is an exceptional fast transient low frequency performance at all power levels.

Efficiency is also maximised. With much smaller transformers than a conventional supply, there is much less loss due to transformer resistance and much less power wasted as heat in the power supply.

Regulation of the SMPS means that the power amplifier will produce the same power output, even if the AC line voltage drops by 20%.

Minimum Load Switches (MLS™)

Because the SMPS is regulated, the maximum power available for the output stages can be adjusted without increased heat dissipation or efficiency loss. This allows the user to match the output power with the loudspeaker impedance.

Protection

The MA4.2 amplifier has many advanced protection features that will protect both the amplifier and the speakers connected to it, under fault conditions. All protection circuits are independent and inaudible in normal use.

Clip Limiters

Clip limiters prevent dangerous clipped signals reaching the speaker. They work by monitoring the output to check for signals not present at the input i.e. distortion. If distortion exceeds 1% on an output, the limiter will reduce the input signal proportionally.

Thermal Protection

Thermal Protection circuitry prevents the amplifier from running at an unsafe temperature by muting the input signal when the internal temperature rises above 90°C.

Short Circuit Protection

The MA4.2 amplifier is completely short circuit protected. The protection circuits permit very high peak currents, but maintain the output devices within their safe operating area.

Mains Voltage Protection

This operates if the mains voltage falls outside its permitted operating range. If this occurs, the power supply will shut down until the correct mains voltage is restored.

DC and VHF Protection

Both DC voltages and high power VHF signals can cause damage to loudspeakers. The MA4.2 amplifier incorporates protection circuits which are activated when damaging DC voltages or VHF signals are present at the outputs.

MA4.2 Specifications

Input Impedance	20kohms (balanced) 10kohms single ended
Gain select switch	41dB (I/P sens 0.775V), 32dB (I/P sens 2.26V)
CMRR at 1KHz	>50dB
Output impedance at 1KHz	<0.06 ohms
Power Bandwidth	5Hz - 20kHz
Slew rate	20V/us
Hum/Noise	<-95dB
Channel Separation	1kHz > 80dB 10kHz > 70dB
Mains Operating Voltage	120 – 270 (minimum start voltage 190) full output power maintained 180 – 280V. Optional (65 - 135V) operation.
Protection	DC, High temperature, Turn on, VHF, Over and under voltage, Clip limiters. AFS Short circuit.
Distortion	
THD 20Hz - 20kHz and 1W – 1000W	4 ohms 0.1% 4 ohms 0.04%
THD at 1 kHz and 2000W	4 ohms 0.04%
DIM 30 at 500W	4 ohms 0.04%
CCIF (13 and 14kHz) at 500W	4 ohms 0.04%
SMPTE (60Hz and 7kHz) at 500W	

Power Matrix

LOAD CONFIGURATION	MLS SWITCH SETTING			
	(-5dB)	(-4dB)	(-2dB)	(0dB)
16 ohms Stereo (2 channel)	220W	260W	410W	650W
8 ohms Stereo (2 channel)	430W	520W	820W	1300W
4 ohms Stereo (2 channel)	830W	1000W	1600W	2100W
2 ohms Stereo (2 channel)	1660W	2000W	2200W	2400W[1]
			3050W[2]	3200W[2]
16 ohms Bridged mono	860W	1040W	1640W	2600W
8 ohms Bridged mono	1660W	2000W	3200W	4200W
4 ohms Bridged mono	3320W	4000W	4400W	4800W[1]

[1] = Component tolerance dependent
 [2] = Continuous power, one channel driven or peak power both channels driven. Thermal protection may occur at high continuous power. Power in watts (EIA 1kHz, 1% THD)

Weight	10kg (22lbs)
Dimensions	(W) 483mm x (H) 88mm x (D) 347mm (W) 19ins x (H) 3.5ins x (D) 13.7ins

3.7 Adding W8CS' to flown W8C systems

Although the Wavefront W8C is often used as a base for smaller floor-stacked or stage-stacked systems (see [Section 1.8](#)), flying W8CS' with main W8C systems can keep the floor tidy and free up floor space for scenery, TV camera tracks etc.

As mentioned earlier, very large outdoor festival crowds will absorb mid-bass from low-profile, ground stacked subwoofers. Flying W8CS' as horn-loaded mid-bass complements the horn-loaded WSX subwoofers to provide an incredibly tight, efficient and detailed bass performance that will shift air and provide a phenomenal kick drum punch.

3.7.1 W8CS/W8C configurations

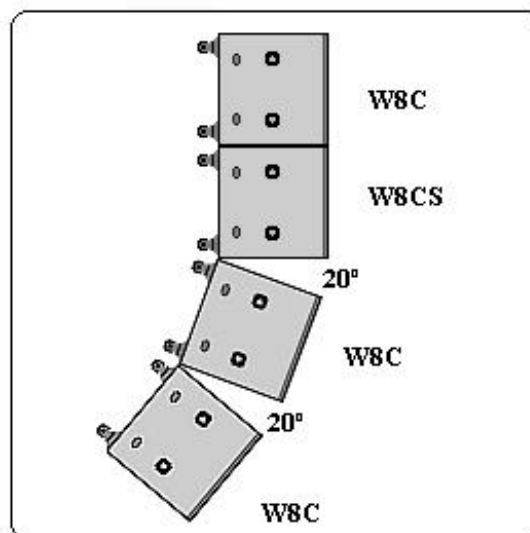
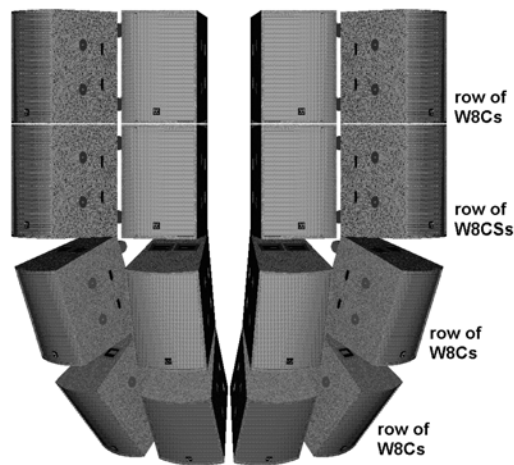

For medium power applications - amplifying a large orchestra, for example, where low frequency stability is important - a single row of W8CS' may be added to a

standard W8C cluster extending its low frequency response to below 45Hz. This configuration can be very efficient as it uses the rest of the cluster as a baffle, increasing forward projection allowing high gain before feedback.

The following iconic layout may be used to represent the above cluster:

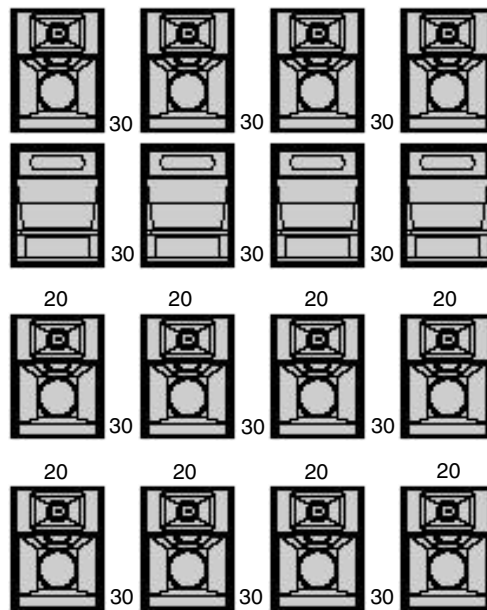

Important reminder:

Splay angles are always quoted axis-to-axis - not between cabinet sides!

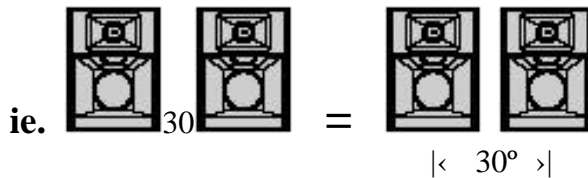

W8CS' flown in rows with W8Cs

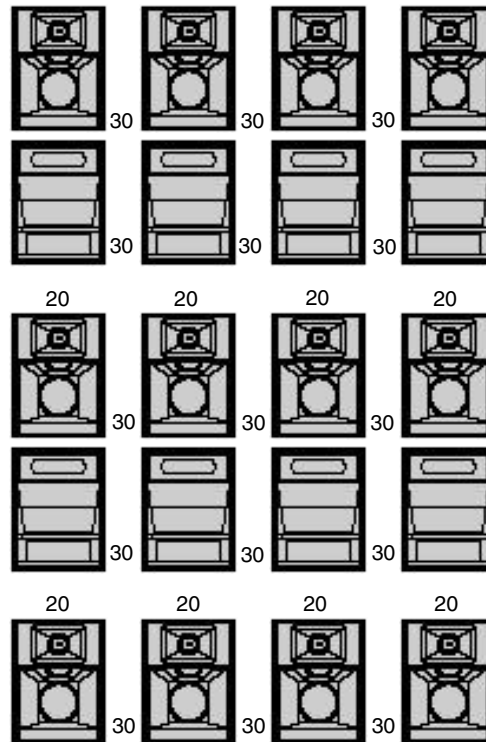

Multiple rows of W8CS' increase low frequency headroom for higher power rock, dance club applications.

Note that flying W8CS' in rows keeps clusters relatively narrow where width is at a premium.

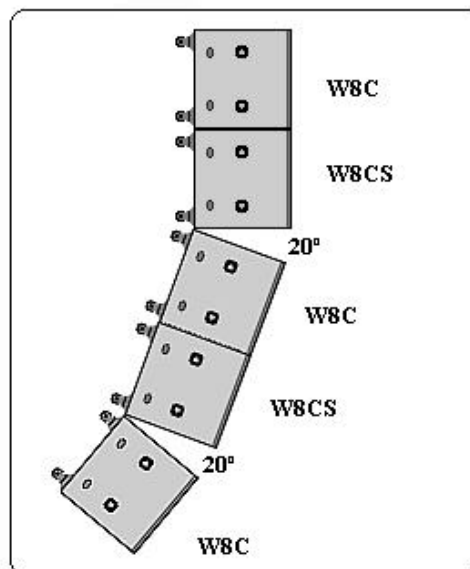

Coverage would be 145° horizontal x 70° vertical.

For *very* high power rock or dance applications, the above W8CS' may be configured

as flown mid-bass elements (crossed in at 60Hz and out at 160Hz) to augment floor-stacked WSXs working as low subs below 60Hz. Refer to [Section 2.4](#).

Power amplifier monitoring at real-world gigs have shown that half of the total system power is demanded between 60Hz & 160Hz during heavy rock and dance music.

W8CS' flown in columns with W8Cs

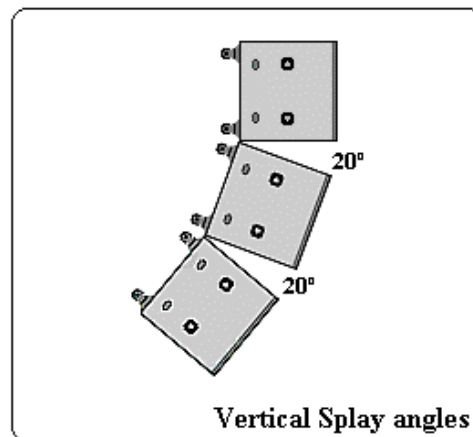
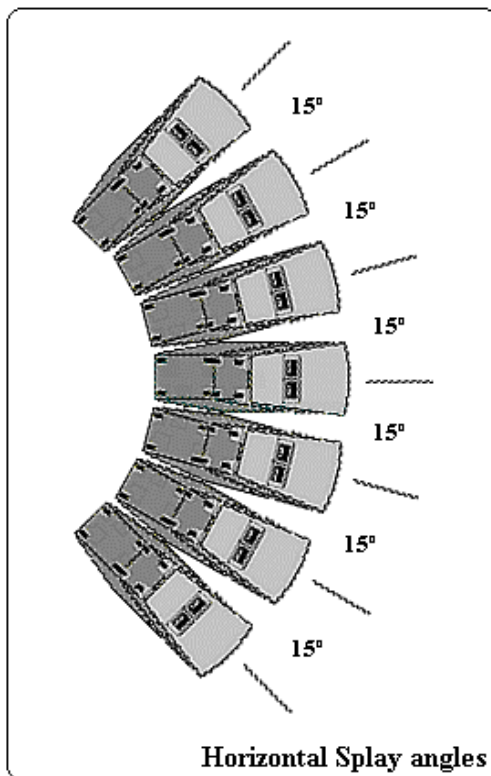
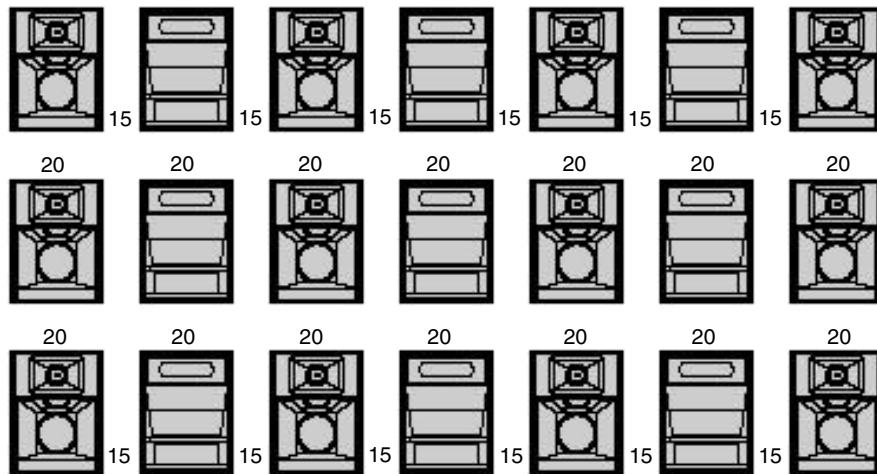

Again, coverage would be 145° Horizontal x 70° Vertical.

Flying W8CS' in columns between W8C columns keeps clusters shorter whilst

providing good vertical control for minimum roof excitation.

W8CS' may be flown as fullbass where floor space is required for TV cameras or may be configured as flown mid-bass elements to complement floor-stacked WSXs.

For further information on suitable Wavefront subwoofer systems and a brief tutorial on bass stack sizes and shapes vs coverage see [Section 4](#).

Wavefront Compact Series

Applications Guide

Section 4

Wavefront WSX

Folded Horn

Subwoofer



The Martin Experience

All material © 2007. Martin Audio Ltd. Subject to change without notice.

Section 4

Wavefront WSX Folded Horn Subwoofer

Contents

- [4.1](#) **Introduction**
- [4.2](#) **Specifications**
- [4.3](#) **Pin-outs and cabling**
- [4.4](#) **System patching**
- [4.5](#) **DX1 Loudspeaker Management System**
- [4.6](#) **Power amplifier recommendations**
- [4.7](#) **Placement**
- [4.8](#) **WSX application examples**
- [4.9](#) **Further examples**
- [4.10](#) **Spaced systems**
- [4.11](#) **Electronic steering**

Wavefront WSX Folded Horn Subwoofer

4.1 Introduction

The powerful WSX folded horn subwoofer is designed to complement Wavefront Series W8C touring systems to provide deep bass with maximum efficiency, speed and impact. Its classic Martin 'S' shaped folded horn is over 7 feet (2.1m) long and couples a powerful 18" (460mm) long excursion driver to the airload with a modified hyperbolic expansion law.

4.2 Specifications

Freq response:	38-150Hz +/- 3dB (half space)
LF limit:	-10dB @ 28Hz
Rated Power:	600W into 8 ohms, 2400W peak
Sensitivity:	105dB (half space with band limited pink noise)
Maximum SPL:	132dB continuous, 138dB peak (half space with band limited pink noise)
Impedance:	8 ohms nominal
Crossover Freq:	150Hz or below
Crossover System:	Martin Audio DX1 Loudspeaker Management System, MX4 or MX5. (See operating instructions)
Connectors:	2 x Neutrik NL8
Dimensions:	(W) 572mm x (H) 1066mm x (D incl wheels) 1065mm (W) 22.5ins x (H) 41.9ins x (D incl wheels) 41.9ins
Weight:	96kg (211 lbs)

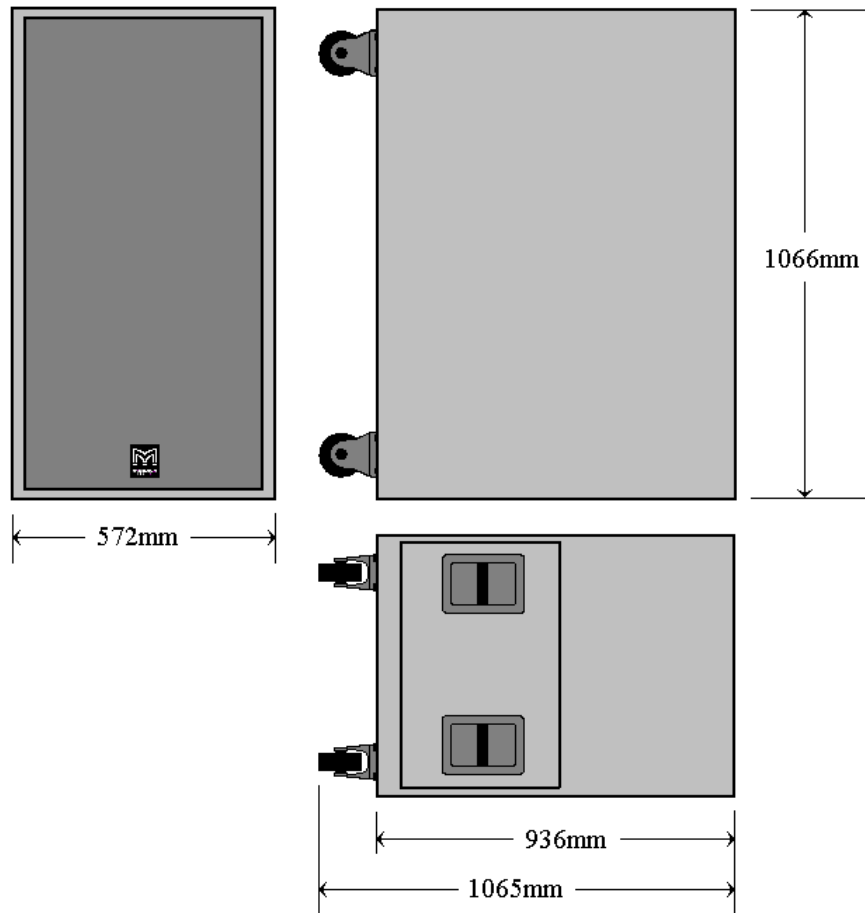

4.3 Pin-outs and cabling

<u>WSX</u>	NL8	WSX
	-1	Driver -
	+1	Driver +
	-2	Driver -
	+2	Driver +
	-3	n/c
	+3	n/c
	-4	n/c
	+4	n/c

(See [Section 1.3](#) for connector pin-out drawing)

4.3.1 Cable and panel connector part numbers

Please note the following part numbers when ordering loudspeaker connectors to make up cables and patch panels

Neutrik NL connectors

NL8FC	8 pole cable (female)
NL8MPR	8 pole panel (male)
NL8MM	8 pole inline coupler (male-male)

Connectors should be kept in good, clean, uncorroded condition to ensure full, undistorted loudspeaker performance. Corroded or damaged pins and sockets can cause severe distortion or loss of signal.

4.3.2 Recommended loudspeaker cable

Although only 4-core cable is required for WSXs, many users will find it convenient to standardise on 8-core NL8 cables to avoid confusion when using other loudspeakers in the Wavefront range.



Cable run vs copper core cross sectional area

	Single WSX	Two WSXs paralleled
Up to 50m	2.5mm ²	6mm ² (or 2 x 2.5mm ² cores in parallel)
Up to 100m	6mm ²	10mm ² (or 2 x 6mm ² cores in parallel)

Q. Why the odd sizes?

A. Loudspeaker cables are available in a limited range of standard copper core sizes - ie. 1.5mm², 2.5mm², 4mm², 6mm², 10mm² and 35mm².

4.4 System patching

Refer to [Section 1.4](#) and [Section 2.4](#) for general Wavefront patching suggestions and examples.

Bass sub-mix operation

Many mix operators prefer to create a separate sub-mix for bass/mid-bass sections. This is good practice as it helps provide main system headroom for those all-important vocals and solos whilst allowing for larger-than-life percussion and bass instrument mixes without intermodulation and distortion.

This configuration can easily be programmed into the Martin Audio DX1

Loudspeaker Management System. The following illustrates a DX1 set up to control an active (3-way) Wavefront W8C system with floor-stacked WSXs augmented by W8CS' configured as flown mid-bass sections.

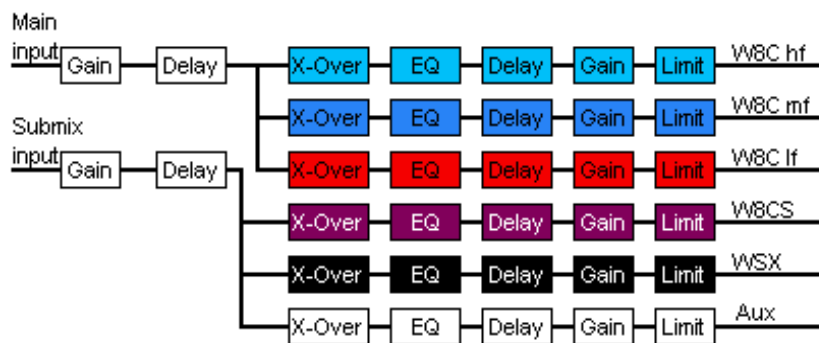

Augmenting WSXs with flown W8CS' as mid-bass sections eliminates the problem of mid-bass absorption experienced with densely packed standing crowds.

4.5 DX1 Loudspeaker Management System

Refer to [Section 1.5](#) for general information on the Martin Audio DX1 Loudspeaker Management System including configuration examples.

4.5.1 DX1 Output Gain and Limiter settings for Wavefront WSXs

Standardising on one good model of power amplifier and correctly set-up controller (preferably the Martin Audio DX1) will provide the most dynamic system performance and protection whilst simplifying design and reducing spares inventories.

The Martin Audio DX1 Loudspeaker Management System may be user-programmed for a wide range of touring configurations based on its 2 input + sum, 6 output matrix. This operation is best completed by an audio technician who is familiar with DSP - based pro-audio equipment.

(See [Section 1.5](#) and [DX1 Speaker Management System User's Guide](#) for further details)

Gain settings

The following initial DX1 output gain settings will enable full system performance to be obtained whilst keeping the console and drive system noise floors inaudible and avoiding amplifier slew-rate limiting:

WSX - assuming 600Wcont - 1200Wpk into 8Ω power amplifiers:

Best-fit Amplifier Example	Amplifier Sensitivity		Amplifier Gain	Initial DX1 Output <u>GAIN</u> When used as:	
	dBu	Vrms	dB	Sub-bass (>60Hz) dB	Full bass (>160Hz) dB
Crown MA5002VZ (0.775v)	-2	0.62	42	-4	-9
<u>Martin MA4.2** (41dB)</u>	-1	0.69	41	-3	-8
Crest CA18 (x115)	-1	0.69	41	-3	-8
Crown MA3600VZ (0.775v)	-1	0.69	41	-3	-8
	0	0.77	40	-2	-7
	+1	0.87	39	-1	-6
	+2	0.98	38	0	-5
	+3	1.09	37	+1	-4
QSC PL236/236A (36dB)	+4	1.23	36	+2	-3
	+5	1.38	35	+3	-2
	+6	1.55	34	+4	-1
	+7	1.73	33	+5	0
<u>Martin MA4.2** (32dB)</u>	+8	1.95	32	+6	+1
Crest 8001 (x40)	+8	1.95	32	+6	+1
Crest 9001 (x40)	+8	1.95	32	+6	+1
QSC PL236A (32dB)	+8	1.95	32	+6	+1
	+9	2.18	31	+7	+2
	+10	2.45	30	+8	+3
	+11	2.75	29	+9	+4
	+12	3.08	28	+10	+5
	+13	3.46	27	+11	+6
Crown MA3600VZ (26dB)	+14	3.88	26	+12	+7
Crown MA5002VZ (26dB)	+14	3.88	26	+12	+7
QSC PL236A (26dB)	+14	3.88	26	+12	+7

**** Set Martin Audio MA4.2 rear MLS switch to 0dB to match peak output of unregulated power amplifiers.**

Limiters settings

The Rated Power specification in [Section 4.2](#) indicates the maximum long-term power dissipation that can be tolerated before driver ageing or damage occurs through overheating or over-excursion.

When choosing power amplifiers, do not be tempted to exceed the 600W into 8Ω power rating unless the amplifier's power rails are well regulated (see [Section 4.6](#)) - even with properly set controllers in place. Although Martin Audio drivers are mechanically designed to survive normal road use and the occasional operator error, overpowered or bridged amplifiers can cause over-excursions that stress and age drivers. The best way to get the clean, relaxed sound of an overpowered amplifier is to choose an amplifier with plenty of current reserve - ie an amplifier with good 2Ω specification - and avoid running more than two cabinets in parallel.

To ensure transparent limiter operation without obvious distortion or pumping, the DX1 limiter attack and release times are factory preset to be inversely proportional to the subwoofer's high pass frequency. These attack times allow the power amplifiers to clip momentarily but not for long enough to be obvious to listeners or cause driver overheating. It is quite normal to see amplifiers *momentarily* clipping on the odd programme peak but continuous clipping would indicate a cable short circuit, wrong controller settings, excessive power amplifier gain or low mains voltage.

High pass filter range	Attack time	Release time
>31Hz	45mS	720mS
31Hz - 63Hz	16mS	256mS

The following initial DX1 output limiter settings will avoid voice coil overheating and minimise amplifier clipping for high quality, trouble free operation.

<u>WSX - assuming 600 W into 8Ω power amplifiers:</u>				
Best-fit Amplifier Example	Amplifier Sensitivity dBu	Amplifier Vrms	Amplifier Gain dB	Recommended DX1 <u>LIMITER</u> Settings dBu
Crown MA5002VZ (0.775v)	-2	0.62	42	-3
Martin MA4.2** (41dB)	-1	0.69	41	-2
Crest CA18 (x115)	-1	0.69	41	-2
Crown MA3600VZ (0.775v)	-1	0.69	41	-2
	0	0.77	40	-1
	+1	0.87	39	0
	+2	0.98	38	+1
	+3	1.09	37	+2
QSC PL236/PL236A (36dB)	+4	1.23	36	+3
	+5	1.38	35	+4
	+6	1.55	34	+5
	+7	1.73	33	+6
Martin MA4.2** (32dB)	+8	1.95	32	+7
Crest 8001 (x40)	+8	1.95	32	+7
Crest 9001 (x40)	+8	1.95	32	+7
QSC PL236A (32dB)	+8	1.95	32	+7
	+9	2.18	31	+8
	+10	2.45	30	+9
	+11	2.75	29	+10
	+12	3.08	28	+11
	+13	3.46	27	+12
Crown MA3600VZ (26dB)	+14	3.88	26	+13
Crown MA5002VZ (26dB)	+14	3.88	26	+13
QSC PL236A (26dB)	+14	3.88	26	+13

**** Set Martin Audio MA4.2 rear MLS switch to 0dB to match peak output of unregulated power amplifiers. (See illustration in [Section 3.5.1](#))**

NOTE!

Use lower settings (or more subwoofers!) if your power amplifiers indicate clipping on more than just the odd peak. Excessive clipping may also be caused by inadequate power amplifier reserve or an inadequate mains supply. See [Section 4.6](#).

4.6 Power amplifier recommendations

The Wavefront WSX Subwoofer has been designed and manufactured for very high performance but will not give that performance unless power amplifiers are chosen and used intelligently.

Power capability

WSXs provide full performance when driven by professional power amplifiers capable of delivering undistorted output power into a range of loads as follows:

WSX

600 W(AES) into 8 ohms
1,200 W(AES) into 4 ohms
and
2,400 W(AES) into 2 ohms

Please note:

Amplifiers with excessive output may damage voice-coils or age driver suspensions due to excessive heat dissipation and excursion.

A note about power amplifier output specifications

Most power amplifier manufacturers keep their costs down by using unregulated supply rails which sag under load. To allow for this sag, manufacturers set their rails high so that they still meet their quoted output into specified loads. These high rail voltages allow such power amplifiers to provide outputs 1.5 - 2 times the power quoted for short-term bursts. Martin Audio products will withstand this potential doubling of instantaneous power - ***with suitably set controller limiters*** - but further, long-term increases caused by over-sized amplifiers should be avoided.

Martin Audio MA series power amplifiers have regulated rails so it is quite permissible to use slightly overpowered models - ***with suitably set controller limiters*** - without risking uncontrolled power bursts. The MA series power amplifiers' regulated power rails also ensure maximum performance under the real-world concert conditions of less-than-optimum mains supplies and low impedance loads. (See [Section 3.6.1](#))

Amplifier load tolerance

An efficient subwoofer system in live concert conditions can act as a surprisingly dynamic and complex load. Most modern touring power amplifiers claim 2 ohm capabilities but make sure your amplifier is also capable of driving reactive (ie inductive or capacitive) loads without prematurely clipping or developing output stage crossover distortion.

Mains safety!

A fully qualified technician should check mains safety and phase voltage *before* the system is patched.

Power reserve

Most power amplifier specifications are based on bench measurements made using stable, high current mains supplies and well defined loads. Amplifiers sound best when they have plenty of current in reserve for percussive peaks and sustained bass notes.

- 1) Try to ensure that the mains supply stays within the amplifier manufacturer's specified range from no load to maximum load.

An electrical technician should check the mains supply vs demand using an accurate rms voltage meter.
- 2) If unfamiliar generators are being used the electrical technician should check the mains waveform (using a portable 'scope-meter) to make sure that it is sinusoidal and not crawling with spikes or interference.
- 3) Avoid driving too many WSXs in parallel. I would suggest no more than two so that the power amplifier's 2 ohm spec is kept in reserve for musical peaks.
- 4) Avoid using power amplifiers in bridged mode. Most commercial power amplifiers are optimised for 2-channel operation. It is usually better to use the appropriate amplifier in 2-channel mode than to use an inadequate amplifier in bridged mode.

Gain or level settings

Gain switches

If you are lucky enough to have amplifiers with user gain switches, set them all to identical positions. A voltage gain in the range 23-33dB will provide a good balance of system headroom and noise (assuming professional audio equipment is in use FOH).

Level controls

The front panel level controls should be turned down (fully counter clockwise) until FOH-to-Amp rack lines have been checked and controllers have been set to suit the power amplifiers to be used (see [Section 4.5.1](#)). Music should be used to check that controllers are receiving and sending the appropriate signal bands and then each power amplifier level control advanced in sequence to check system operation and patching.

Assuming that controller output levels and limiters have been set as tabulated in [Section 4.5.1](#), power amplifier level controls should be set to full (fully clockwise) for loudspeaker sections requiring the strongest drive. Other amplifiers - driving apron subwoofer sections, for instance - may be backed off as required for smooth coverage.

This process will ensure that the system remains balanced during limiting.

Rack mounting

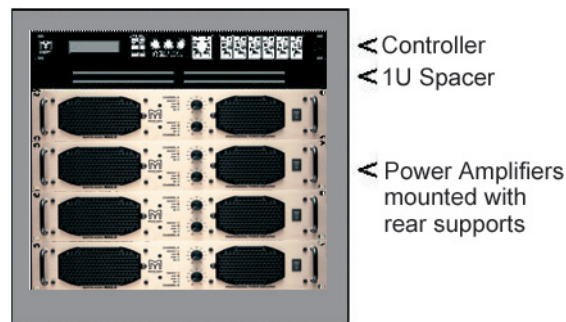

As with main W8C systems, always leave a 1U space between subwoofer power amplifiers and controllers. Although most modern amplifiers don't radiate significant fields it's better to play safe and keep the system free from hum & buzz. Rear supports are recommended. Check the manufacturer's application notes for details.

4.7 Placement

The WSX is designed to be ground stacked. Ground stacking maintains maximum efficiency and provides the solid mounting essential for good dynamics.

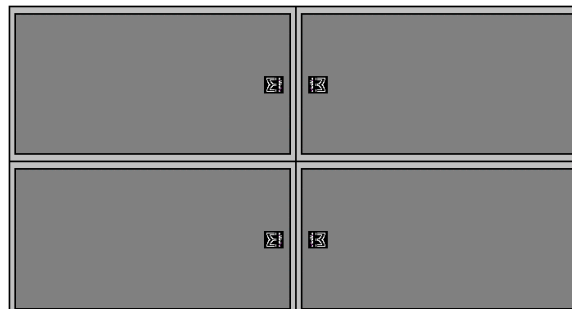

WSX horns flare away from the label end. They can be symmetrically coupled by placing them label-to-label ...

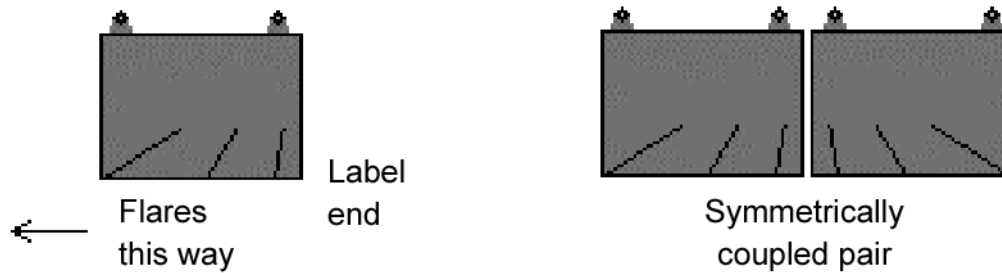

Symmetrically coupled 2-wide columns show a slight improvement in mid-bass amplitude and polar response - but the effect becomes insignificant in large, flat fronted arrays or widely spaced stage apron systems.



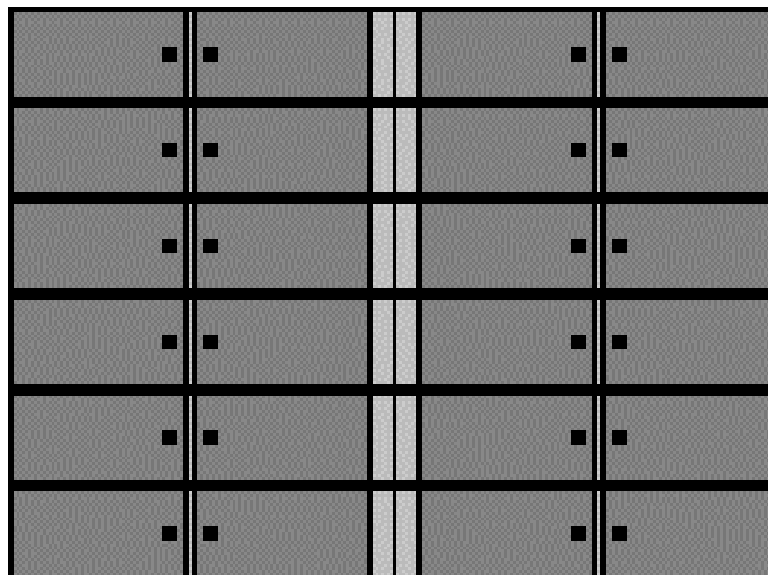
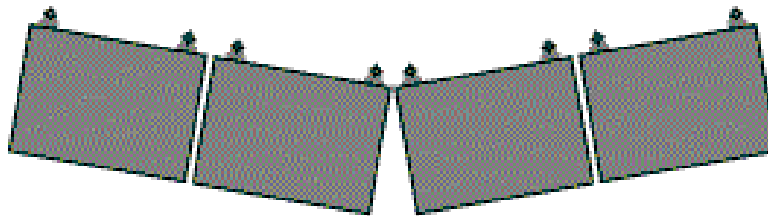

2-wide symmetrical columns of WSXs may be horizontally arrayed just like main cluster systems.



4.7.1 Array shapes vs coverage

WSXs may be stacked and arrayed to increase sound pressure and tailor coverage. The sound pressure increase is intuitive but the significance of subwoofer array shapes and sizes is often overlooked.

The following table shows the sound pressure boost and coverage provided by a variety of flat fronted arrays:

Array	Approx Boost (wrt single unit)	Horizontal coverage	Vertical coverage
	-	Wide	Wide
	+12dB	Wide	Narrow
	+12dB	Narrow	Wide
	+24dB	Narrow	Narrow

In these examples “wide” means that there are no coverage nulls within the forward 180° at mid-bass crossover frequencies. Wide coverage arrays have significant output beyond 180° making them more prone to room colouration.

“Narrow” means that coverage will drop significantly before 180° coverage is reached at the mid-bass crossover frequency.

General rules:

- ◆ *The larger the array the more directional it becomes*
- ◆ *A larger, directional system will be less affected by the room*
- ◆ *We get a 6dB far field sound pressure boost every time we double the number of cabinets*

Stacking safety!

Stacked WSXs should always be blocked, strapped and anchored from above by a qualified rigger.

4.7.2 Coverage angle for tightly packed flat fronted arrays

-6dB Coverage

Here is a simplified formula for calculating the main coverage angle of a tightly packed flat fronted array.

$$\text{Main coverage angle} = 2 \times \arcsin \left(\frac{0.61\lambda}{Nd} \right)$$

(between -6dB points
either side of axis)

where λ = the sound wavelength in meters = $\frac{340^*}{\text{Frequency (Hz)}}$
 N = the number of subwoofers
 d = the centre-to-centre spacing
 (d = the subwoofer width or height if tightly packed)

* = approximate speed of sound in m/s. Varies with temperature (see [Section 2a](#)).

Arcsin means “the angle whose sin is ...”

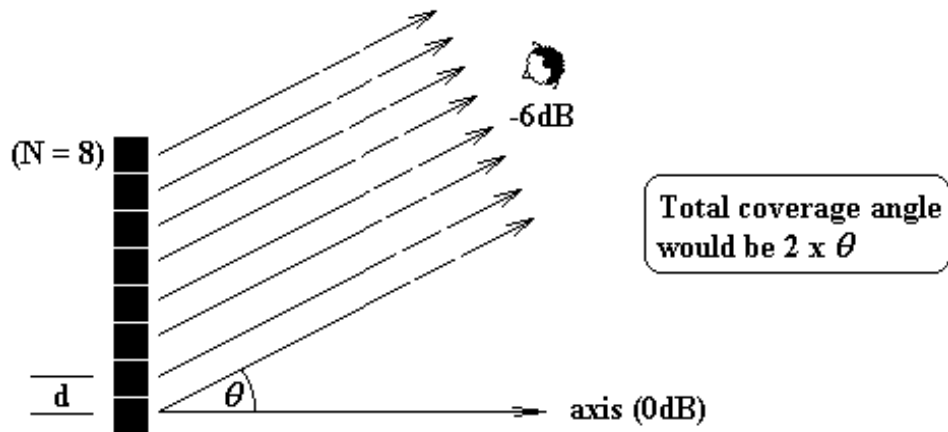

Flat fronted cluster coverage patterns will be confined to one main lobe whose mid-bass crossover directivity is proportional to the size of the cluster.

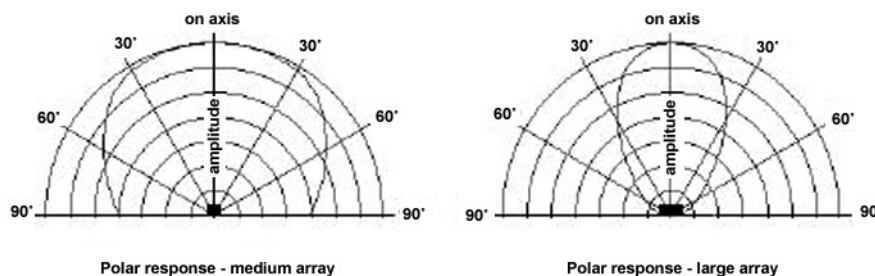

The medium sized array (left) has significant output to $\pm 90^\circ$ whereas the large array's $\pm 90^\circ$ output is dramatically reduced.

A note on coverage nulls

It is useful to be able to calculate where these first response nulls will occur for various frequencies as they indicate areas where coverage, transient response and directional information would be poor without fill systems. For symmetrical arrays nulls will occur either side of the on-axis line. We can calculate the overall “null-to-null” angle using the simple formula:

$$\text{Null-to-null angle} = 2 \arcsin \left(\frac{\lambda}{Nd} \right)$$

As a very rough guide, the null-to-null angle will be approximately twice the -6dB coverage angle.

Interpreting polar plots

i) It is conventional to “normalise” polar plot on-axis amplitudes so that different polar shapes may be readily compared. In practice, the large array (right example) would have a higher on-axis amplitude than the medium array.

ii) It is also conventional to plot polar amplitudes on a logarithmic scale. This is fine when working in sound pressure level terms but is not suitable for superimposing a polar plot onto a venue plan. Venue plans are drawn to a linear scale so polar plots with linear amplitude scales would be more suitable.

iii) Polar plots have been simplified in this article for clarity. Real-world off-axis lobe amplitudes and shapes would vary considerably depending on boundary loading, echoes, reverberation and other audio sources affecting the same space.

Vertical -6dB coverage

The following table gives the approximate vertical coverage angles of typical WSX arrays - ignoring boundary effects (see later).

WSXs High (on sides)	Vertical coverage		
	40Hz	80Hz	160Hz
3	Wide	Wide	98°
4	Wide	Wide	69°
8	Wide	69°	33°
16	69°	33°	16°

- ◆ *Use tall stacks for long shots. Useful for long distances in low-roofed venues with raked seating up to the height of the stack*
- ◆ *Use short stacks for short, wide vertical shots*
- ◆ *Use tall, electronically steered, stacks to project to high, distant seating - see [Section 4.11](#)*

Vertical Boundary effects

A solid floor will act as a reflector. This will cause a vertical stack to perform as if it were double the length, giving a useful low frequency boost accompanied by a narrower, more complex polar response.

For instance, an 8 high ground-based stack of WSXs will act like the top half of a 16 high stack.

At 80Hz its smoothest vertical coverage will be from the floor to its own height (4.6m) + 16.5°. It will, therefore, cover seats 19m above floor level at a distance of 50m and 34m above floor level at 100m.

It is possible to reach higher seating areas whilst retaining the long throw characteristics of a tall vertical stack by electronically “tilting” the system - see [Section 4.11](#).

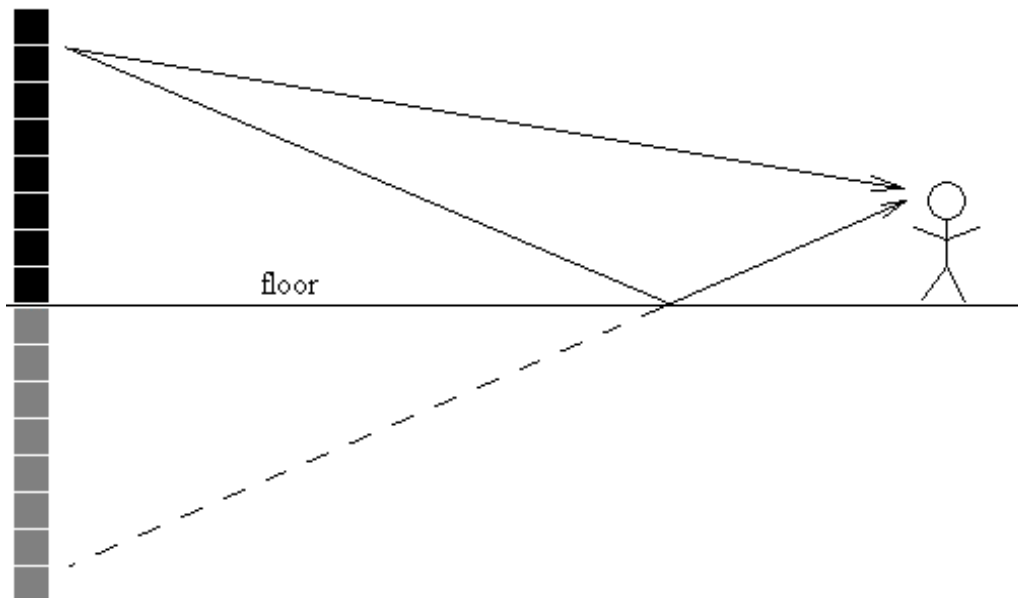

Note that flexible floors may actually absorb sound at some frequencies so the situation isn't always so simple in practice.

Horizontal - 6dB coverage

The following table gives the approximate horizontal coverage angles of typical WSX arrays - ignoring boundary effects.

WSXs Wide (on sides)	Horizontal coverage		
	40Hz	80Hz	160Hz
2	Wide	Wide	75°
4	Wide	75°	35°
8	75°	35°	17°
16	35°	17°	9°

WSXs Wide (standing upright)	Horizontal coverage		
	40Hz	80Hz	160Hz
3	Wide	Wide	98°
4	Wide	Wide	69°
8	Wide	69°	33°
16	69°	33°	16°

With WSXs standing upright, flat fronted cluster coverage patterns will be confined to one main lobe whose mid-bass crossover width is inversely proportional to the size of the cluster as long as horizontal gaps are less than 500mm.

- ◆ *Use wide arrays for long shots. Useful for long, narrow venues*
- ◆ *Use narrow arrays for short, wide shots*

Horizontal Boundary effects

A solid wall near an array will act as a reflector. This will cause a horizontal array to perform as if it were twice as wide, giving a useful low frequency boost accompanied by a narrower, more complex polar response.

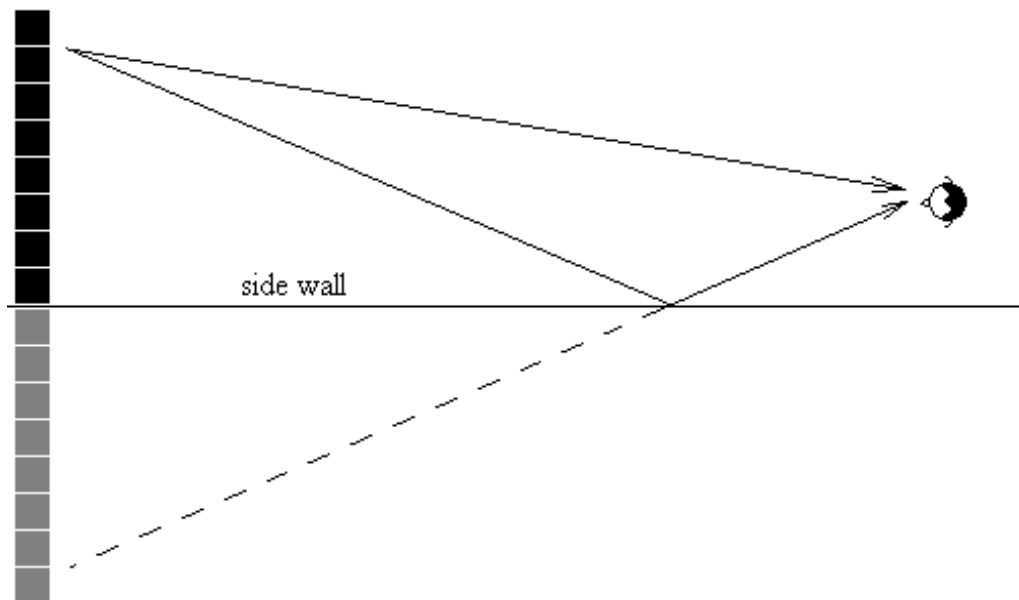

Again, a flexible side wall may absorb sound at certain low frequencies. Boundaries should always be treated with caution.

4.7.3 Spacing

It is possible to space out WSXs to provide a larger frontal area with fewer units but care must be taken to avoid irregular coverage at higher, mid-bass frequencies.

The following formula gives the pressure ratio $p(\theta)$ (wrt to the on-axis pressure) for any off-axis angle of a regularly spaced linear array:

$$p(\theta) = N \frac{\sin[(N\omega d/2c) \sin \theta]}{N \sin[(\omega d/2c) \sin \theta]}$$

where N = the number of subwoofers
 d = the centre-to-centre spacing
 c = the speed of sound = 340m/s*
 θ = the angle (wrt the axis)
 $\omega = 2\pi f$

* varies with temperature

Far field polar patterns can be quite complicated - even for a simple pair of subwoofers driven in unison.

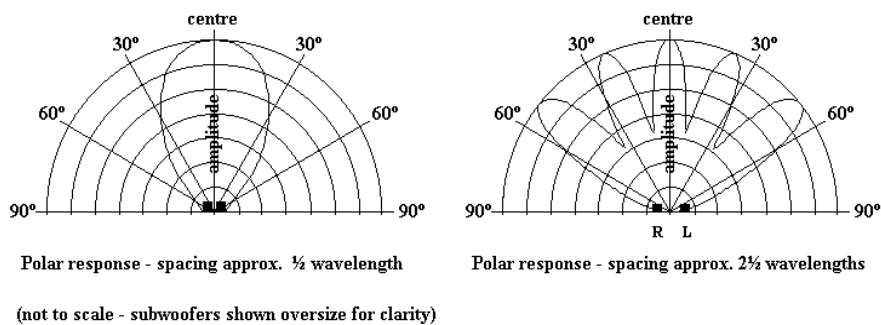

Wide spacing will cause off axis irregularities (combing) because time offsets start to become significant. See [Section 4.10](#) for a more detailed explanation.

- ◆ *An odd number of half wavelengths will cause nulls along the line of the loudspeakers (the 90° lines) - see the 2½ wavelength example above.*
- ◆ *An even number of half wavelengths will cause lobes along the line of the loudspeakers - see the 2 wavelength example below.*

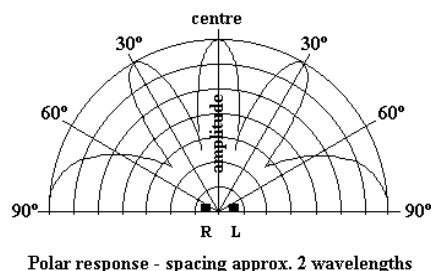

The following tables give the maximum recommended gap (between WSX sides) for the relevant frequency range.

WSXs standing upright

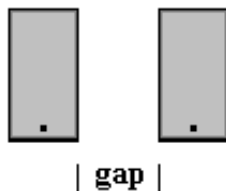

Gap	Smooth coverage range
0.5m	38 - 160Hz
1.0m	38 - 110Hz
2.0m	38 - 80Hz

WSXs lying horizontally

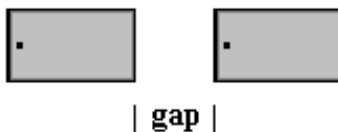

Gap	Smooth coverage range
0.0m	38 - 160Hz
0.5m	38 - 115Hz
1.0m	38 - 86Hz
2.0m	38 - 60Hz

To avoid combing...

- ◆ *Keep horizontal gaps below 1m for upright WSXs*
- ◆ *Keeps horizontal gaps below 0.2m for horizontal WSXs*

4.7.4 Horizontal splays

Splaying WSX arrays horizontally will widen their mid-bass coverage.

The following sketch shows an 8 wide x 3 high WSX array arranged in four symmetrical pairs for smooth mid-bass coverage.

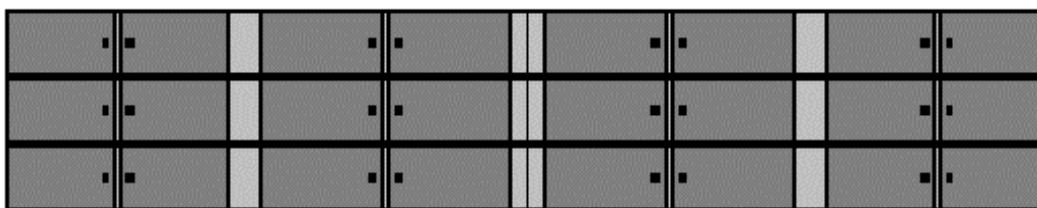
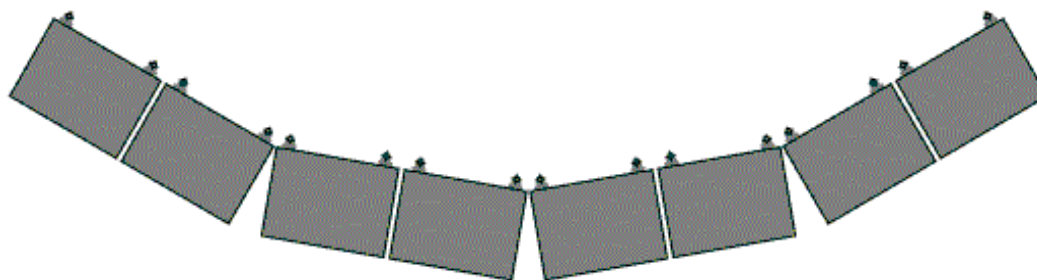

WSXs Wide

(On sides.

Splayed with

Radius = width)

2
4
8
16

Horizontal coverage

	40Hz	80Hz	160Hz
2	Wide	90°	60°
4	90°	60°	30°
8	60°	30°	36°
16	30°	36°	40°

Note that lower frequencies remain focussed when large arrays are used with large radii. Smaller systems with small radii will widen coverage at all frequencies but may cause low frequency build-up on thrust and island stages. Avoid this problem by augmenting small stage corner systems with WSXs placed along the stage apron.

For a smooth polar crossover:

- ◆ *Array the WSXs to match the curvature of the main clusters' low-mid or mid-bass section whenever possible but avoid making the front horizontal gaps greater than 200mm*
- ◆ *Avoid large gaps between the main system and the WSXs whenever possible*

4.8 WSX application examples

The following sketches show how WSXs may be deployed for a wide range of productions and types of venue. All productions and venues present their own unique requirements and these examples are intended as a template or starting point for your own specific design.

Examples 1 and 2 show typical set-ups for smaller venues.

(1) WSX set-up for small, high power variety/orchestral production

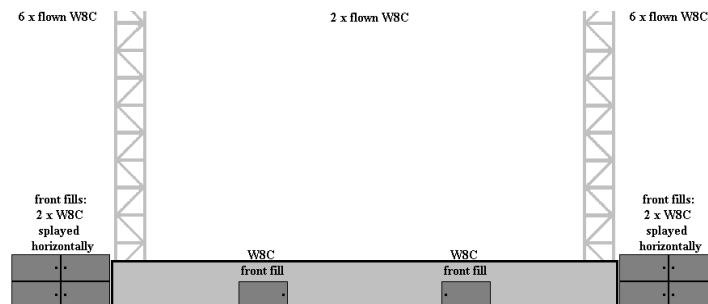

Gives medium vertical & wide horizontal coverage up to 120Hz - allowing for ground effects.

Example 1 uses small stacks of WSXs for a high power variety or orchestral production as it is quite desirable to excite the natural room acoustic for this type of application.

(2) WSX set-up for small, very high power dance/rock production

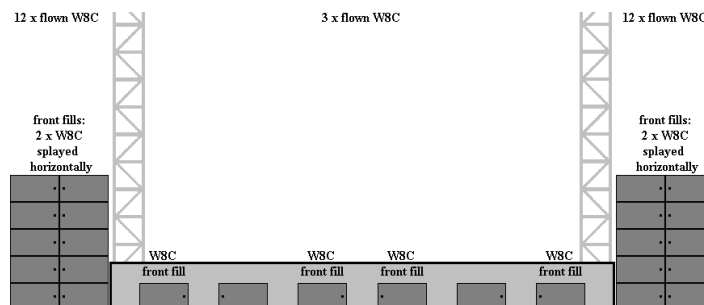

Gives very narrow vertical & wide horizontal coverage up to 120Hz - allowing for ground effects.

Example 2 shows a tight vertical set-up for a very high power dance or rock event where it is desirable to keep low frequency energy concentrated on the audience for maximum bass/mid-bass punch without excessive roof excitation. Note that the apron WSXs are there to provide smooth nearfield coverage, balance backline leakage and keep the overall sound image locked onto the stage. The closer spacing, used for the very high power set-ups, helps maintain bass/mid-bass focus out to the midfield/mix position.

(3) WSX set-up for very high power dance/rock production in narrow arena

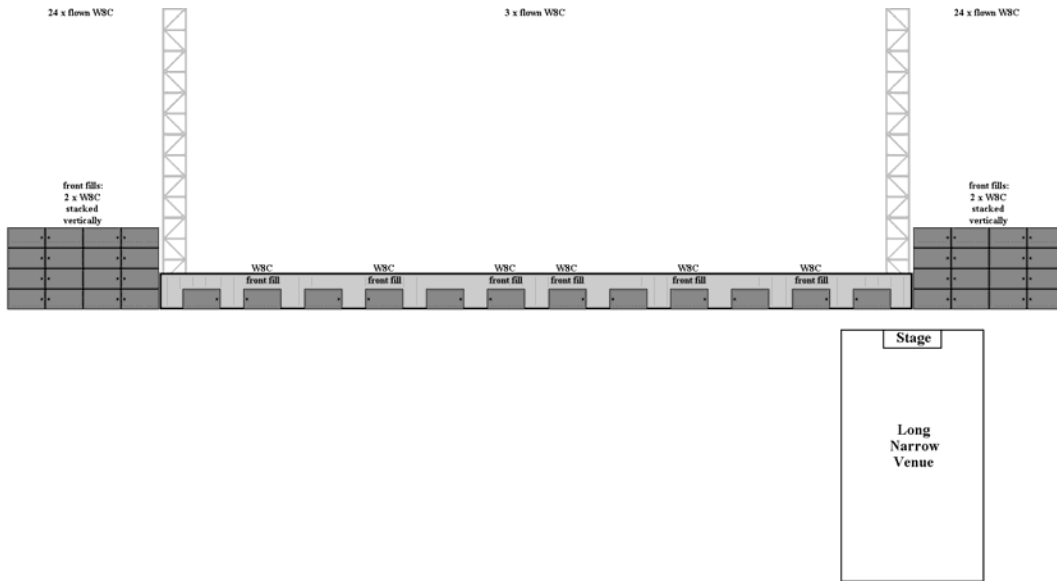

Gives narrow horizontal & vertical coverage up to 120Hz - allowing for ground effects.

Example 3 shows a very high power dance or rock set-up for a narrow “shoe box” venue. Note the four-wide left and right WSX arrays for tight horizontal control and the more tightly packed apron systems for central focusing.

(4) WSX set-up for very high power dance/rock production in wide arena

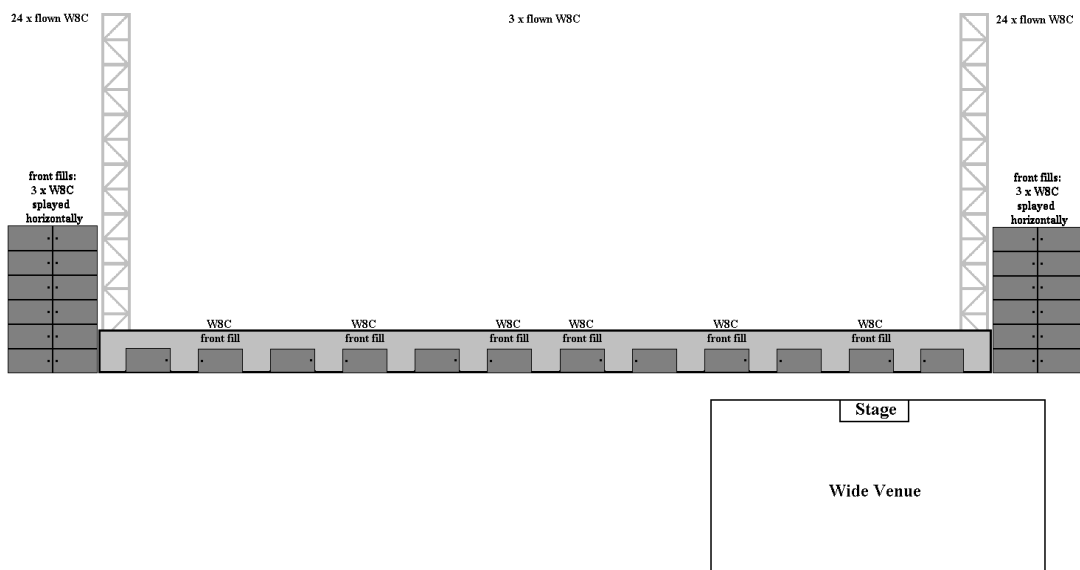

Gives wide horizontal & very narrow vertical coverage up to 120Hz - allowing for ground effects.

Example 4 shows a similar set-up - but this time for a wider venue. Note the narrower left and right WSX stacks for wider horizontal coverage.

(5) Alternative set-up for wide venues

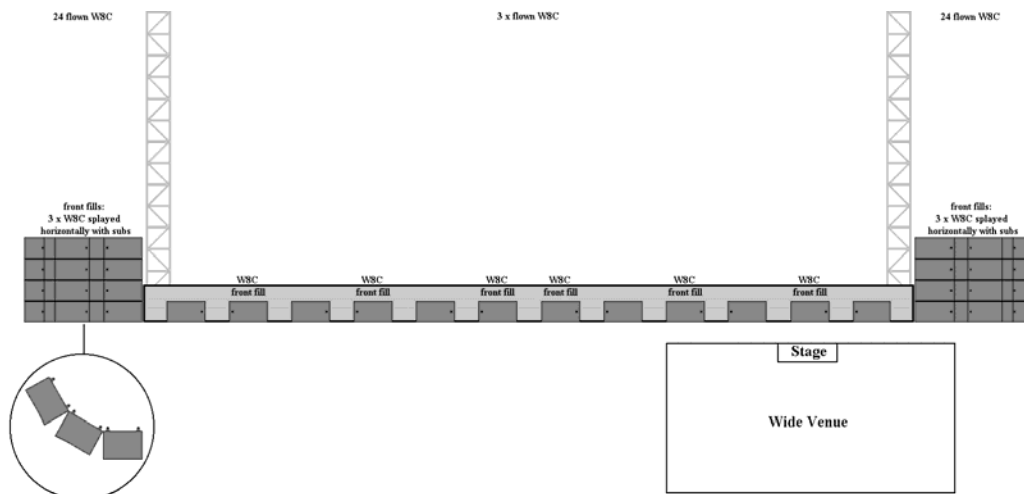

Splayed WSX arrays for wide horizontal coverage.

Example 5 shows a set-up for a TV shoot in a similar wide venue where sight-lines are critical. Note the lower profile, splayed left and right WSX arrays.

4.8.1 System alignment

As with all sound system components, a few moments setting up the subwoofer system for smooth coverage and maximum impact will ensure that the mix operator is hearing a true representation of the auditorium sound and save a lot of surprises and head scratching later.

In all cases...

- 1) Set the main L&R WSX stacks to match the main L&R system farfield levels around 120Hz, fine-tuning system delays as required.
- 2) Set the L&R stack front-fills to balance the main L&R systems + WSXs in the nearfield - again, using system delays as required.
- 3) Set the flown centre-fills to balance the main L&R systems + WSXs in the centre midfield/mix position.
- 4) Set the apron-fill loudspeakers to focus the central nearfield region. For opera recitals, some of these may be used for voice imaging only and be progressively delayed to the principal vocal microphone position.
- 5) Set the apron WSX levels to match the band/orchestra apron-fill loudspeakers around 120Hz.

4.9 Further examples

Thrust stages

Examples 6 and 7 show typical set-ups for large, thrust stage productions.

(6) WSX set-up for high power variety/orchestral production on large thrust stage

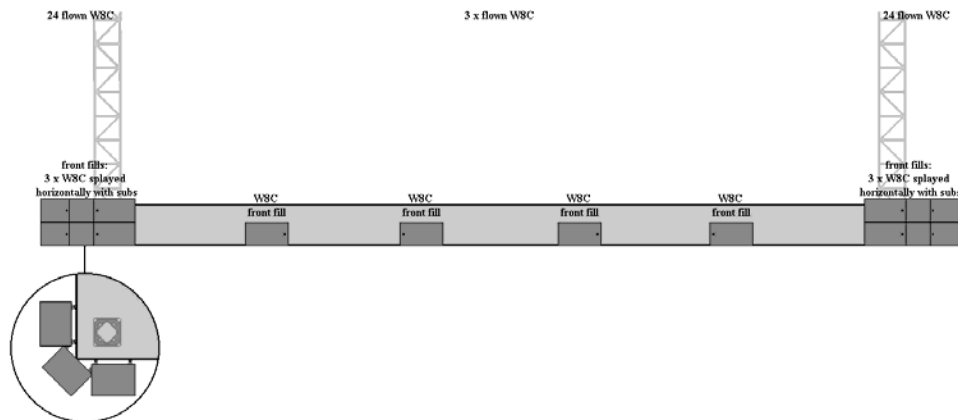

front view

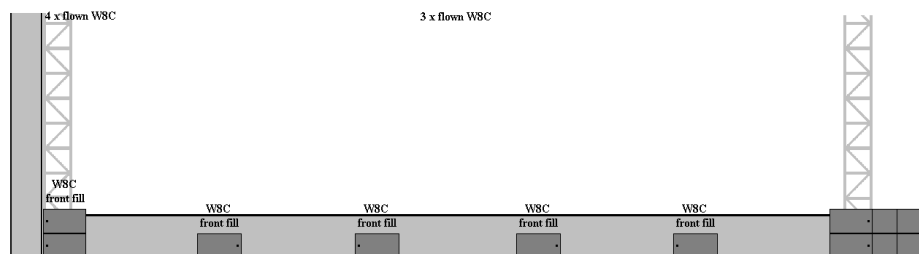

side view

Gives medium vertical & wide horizontal coverage up to 120Hz for audience on 3 sides - allowing for ground effects.

- 1) *Set the front & rear WSX arrays to match the main front & rear system farfield levels around 120Hz*
- 2) *Set the front & rear W8Cs to balance the main systems + WSXs in the nearfield*
- 3) *Set the flown centre W8Cs to balance the main systems + WSXs + W8Cs in the L, R & centre/mix position midfield areas*
- 4) *Set the apron W2s to fill the L, R & centre nearfield region*
- 5) *Set the apron WSXs to match the W2s around 120Hz*

Again, left and right WSX arrays (but this time at front and rear) are augmented by apron fills. The system set-ups may be thought of as three-sided versions of examples 3 and 5.

(7) WSX set-up for very high power dance/rock production on large thrust stage

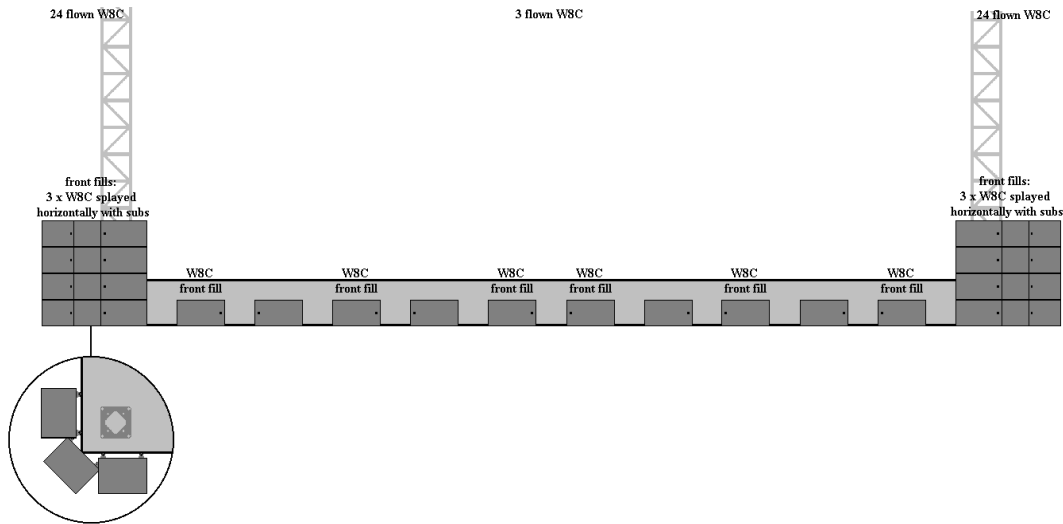

front view

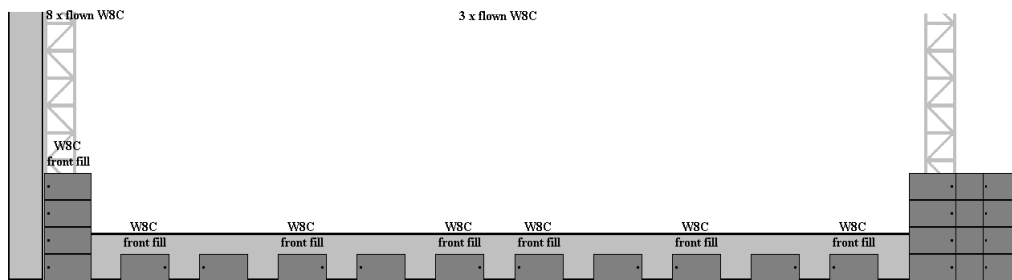

side view

Gives narrow vertical & wide horizontal coverage up to 120Hz for audience on 3 sides - allowing for ground effects - with tighter apron WSX spacing for more coherent nearfield mid-bass coverage and punch.

- 1) *Set the front & rear WSX arrays to match the main front & rear corner system farfield levels around 120Hz*
- 2) *Set the front & rear W8Cs to balance the main systems + WSXs in the nearfield*
- 3) *Set the flown centre W8Cs to balance the main systems + WSXs + W8Cs in the L, R & centre/mix position midfield areas*
- 4) *Set the apron W3s to fill the L, R & centre nearfield region*
- 5) *Set the apron WSXs to match the W3s around 120Hz*

Island stages (not shown)

Island stages are simply four-sided versions of examples 3 and 5 and should be aligned using the same process.

4.10 Spaced systems

Whenever two or more loudspeaker systems are fed with the same signal and their coverage overlaps, sound addition and subtraction will take place depending on the listener's position.

In the following example, the off-axis listener may hear delayed sound from the right hand system.

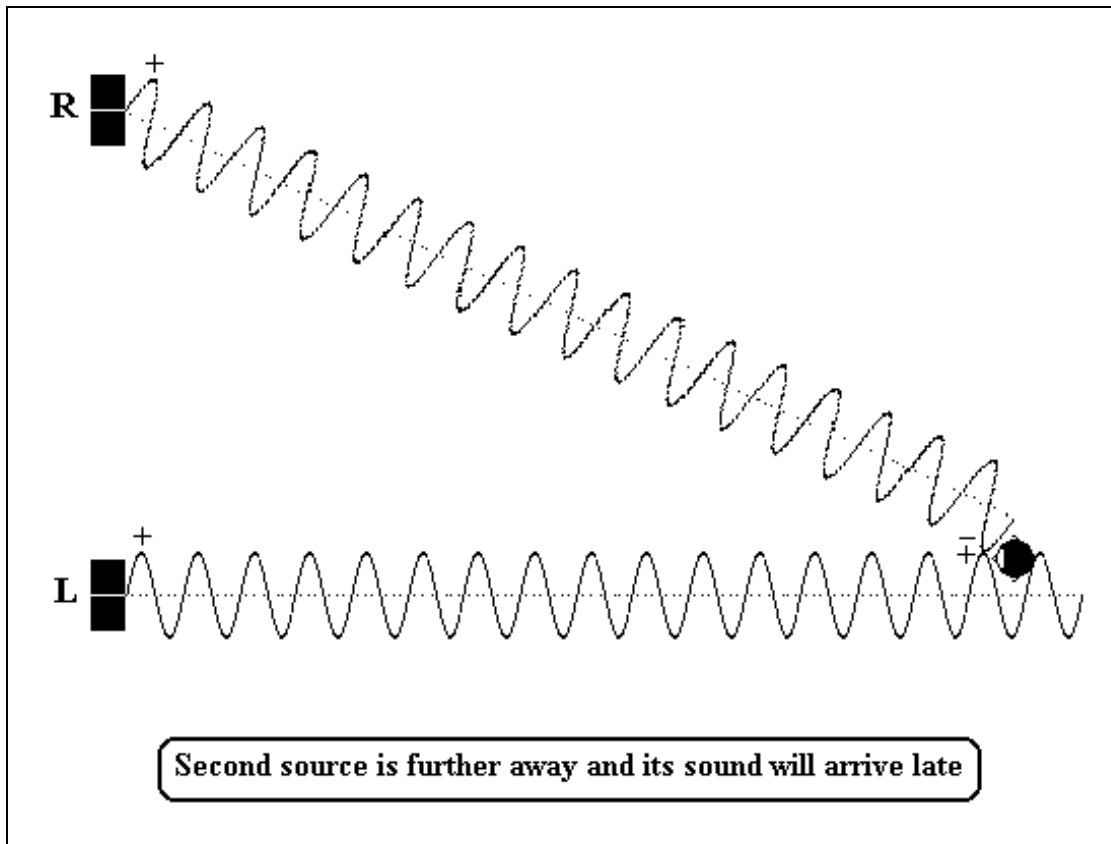

The two loudspeakers are driven in phase (both were +ve just before the instant shown) but the extra distance travelled by the second (R) signal causes it to be out of phase at the listener position at that particular frequency (R is -ve while L is +ve).

Reflections

Remember that a strong side wall reflection will act like a second source and the direct and reflected signal will combine as if they were two sources.

The following illustration shows what will happen. The direct signal will combine with the reflected signal as if it were a phantom source in the position shown.

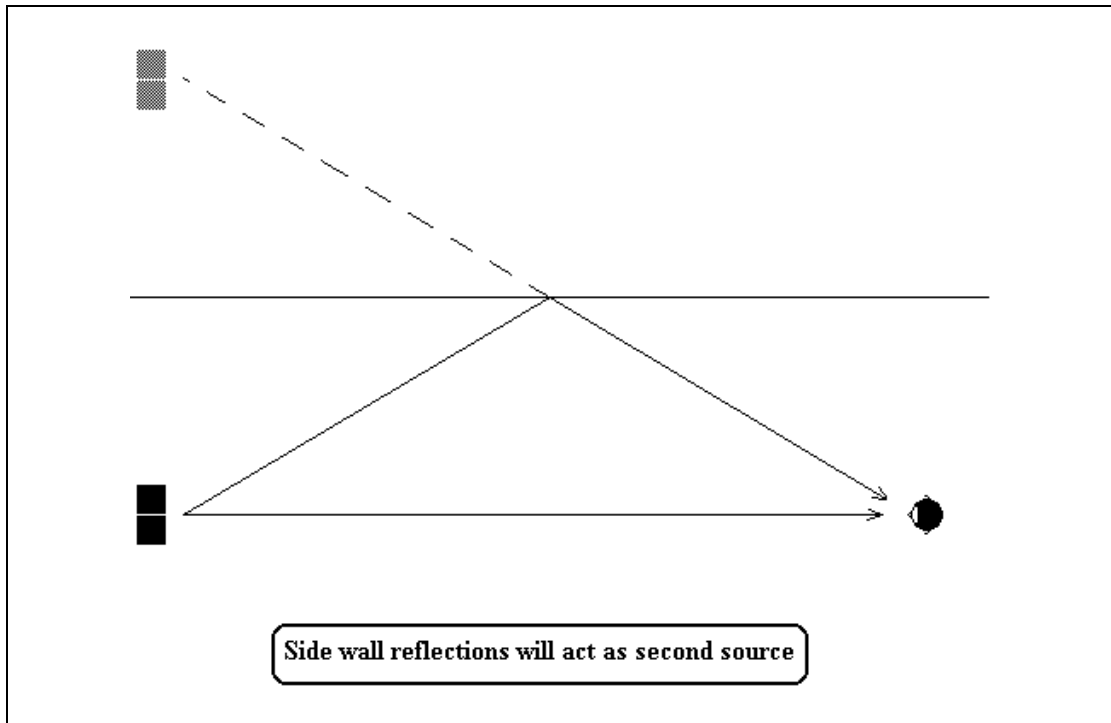

Addition & Subtraction

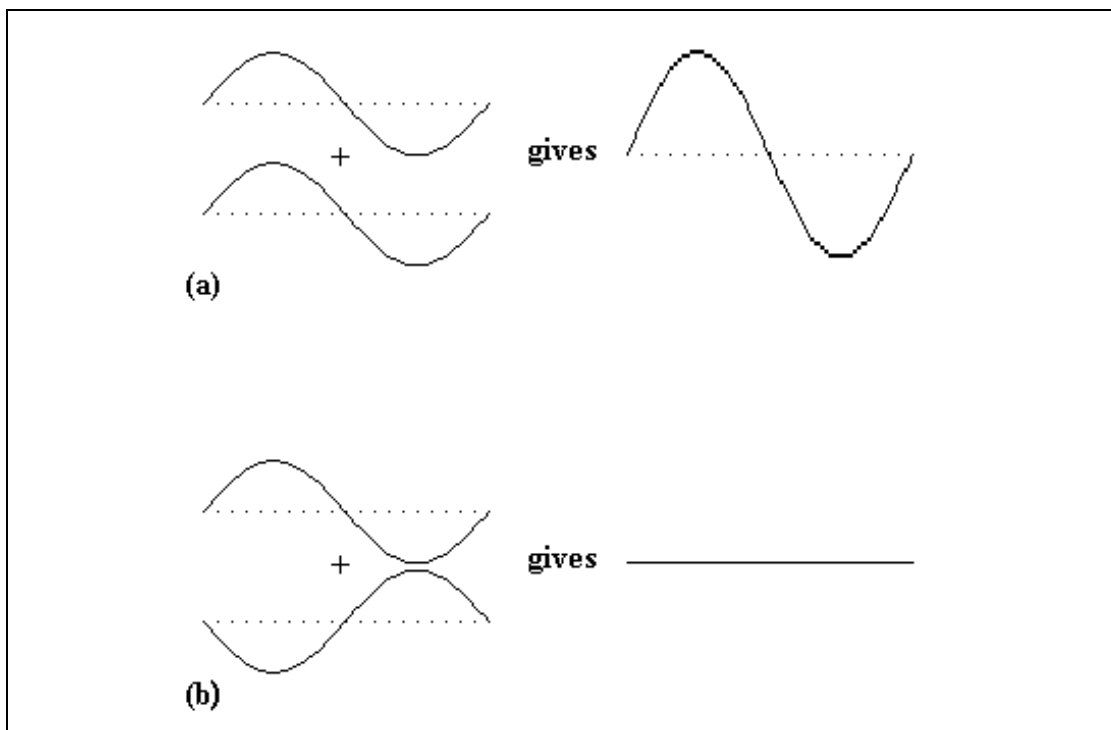

The above shows how two pairs of sine waves (with identical amplitude and frequency characteristics) will sum. Pair (a) are in phase and add. Pair (b) are out of phase and cancel.

Polar variations with frequency

Whether particular frequency components add or subtract in the far field will depend on the loudspeaker system spacing, the angular offset of the listener with respect to the centre line, and the wavelength.

The following polar responses show what happens when subwoofers are placed 8.6m apart and are driven in unison at various frequencies:

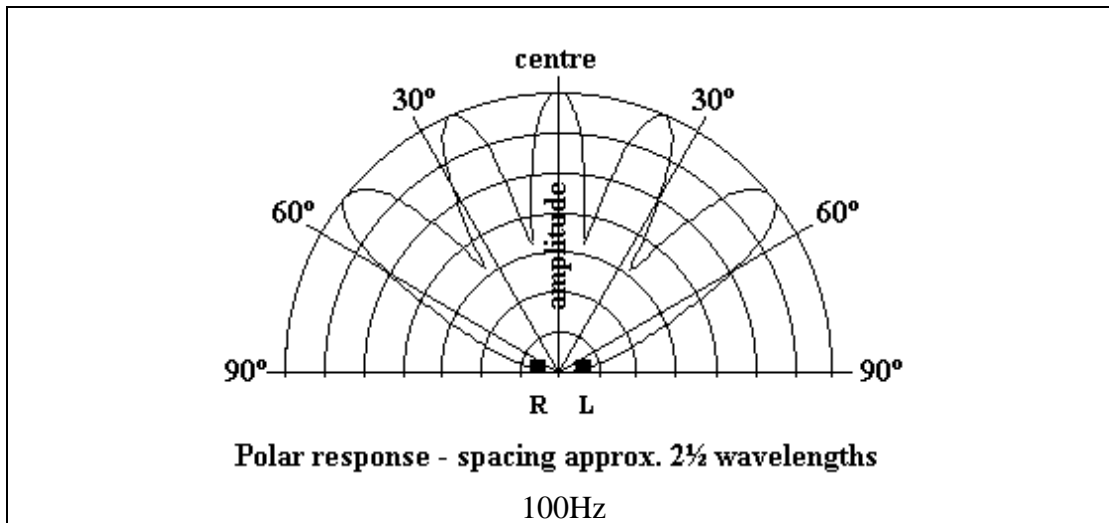

The polar plot shows the far field polar response of the two subwoofers when driven in phase with the same 100Hz signal. Subwoofer interaction causes irregular coverage either side of the centre line.

Response nulls (cancellations) occur at the sides because the spacing is an odd number of half-wavelengths causing this frequency component to cancel in the far field.

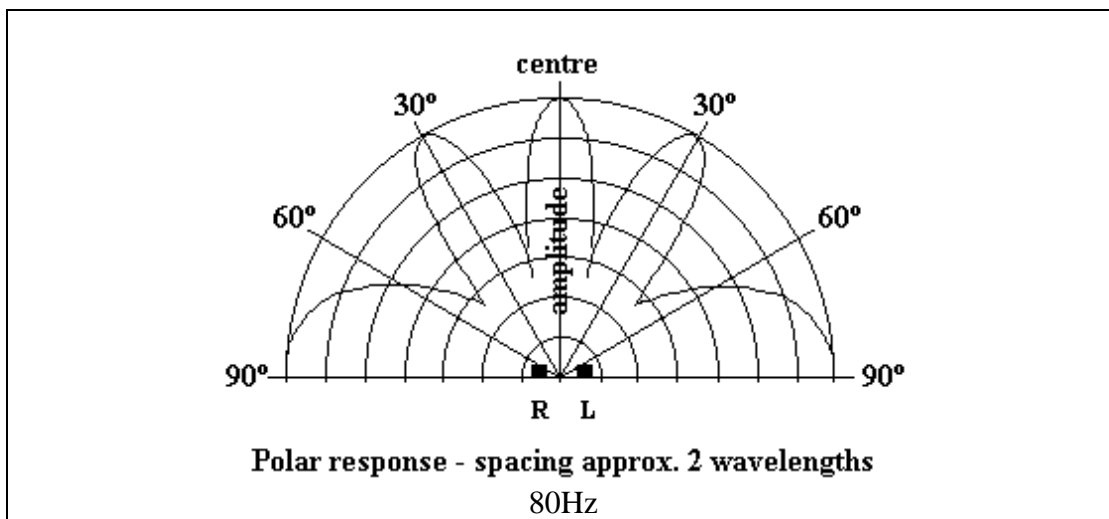

The above shows the same system at 80Hz.

At this frequency the central position remains well covered but the polar pattern has

changed dramatically around the sides. There are now strong lobes at the sides because the spacing is now an even number of half-wavelengths at this particular frequency. These lobes could cause low frequency feedback problems on stage with the high microphone gains used for orchestral low string (cello, double bass) sections or for “unplugged” performances.

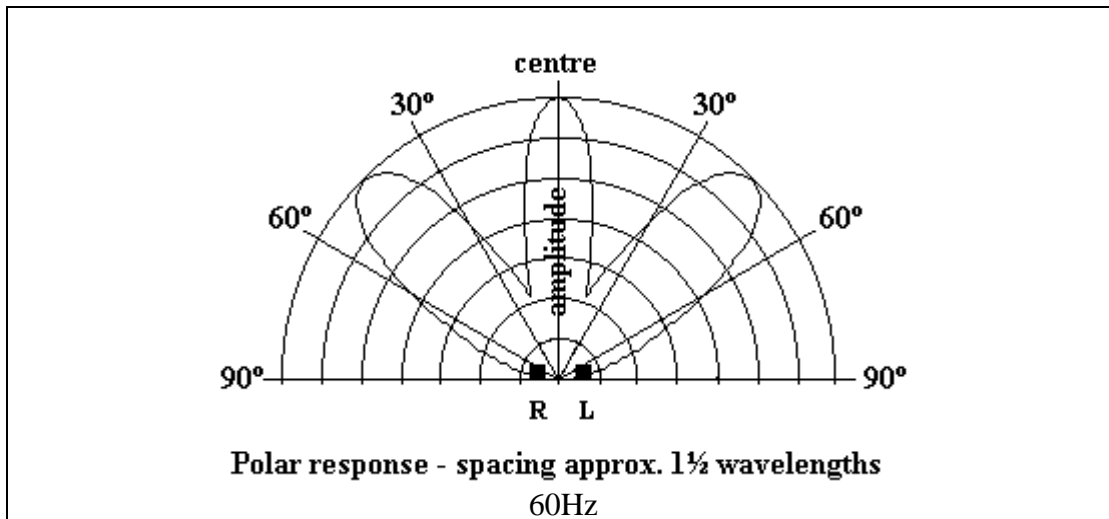

At 60Hz the spacing is an odd number of half-wavelengths again so we see side nulls again.

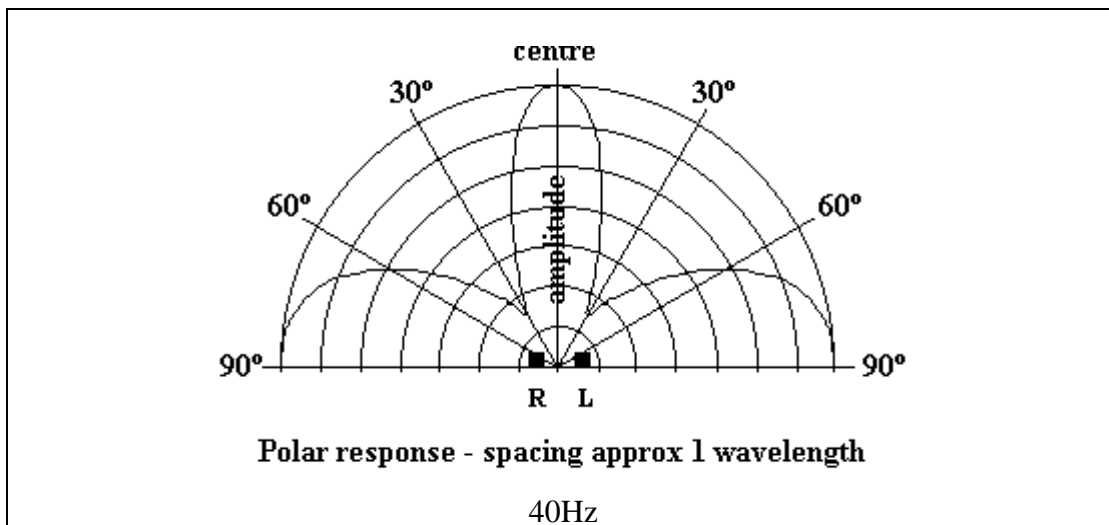

When the frequency drops to 40Hz, the 8.6m spacing = 1 wavelength.

Again, the central response is maintained but there is a dip in response over wide areas either side of the centre. The spacing is an even number of half-wavelengths again so we see side lobes again.

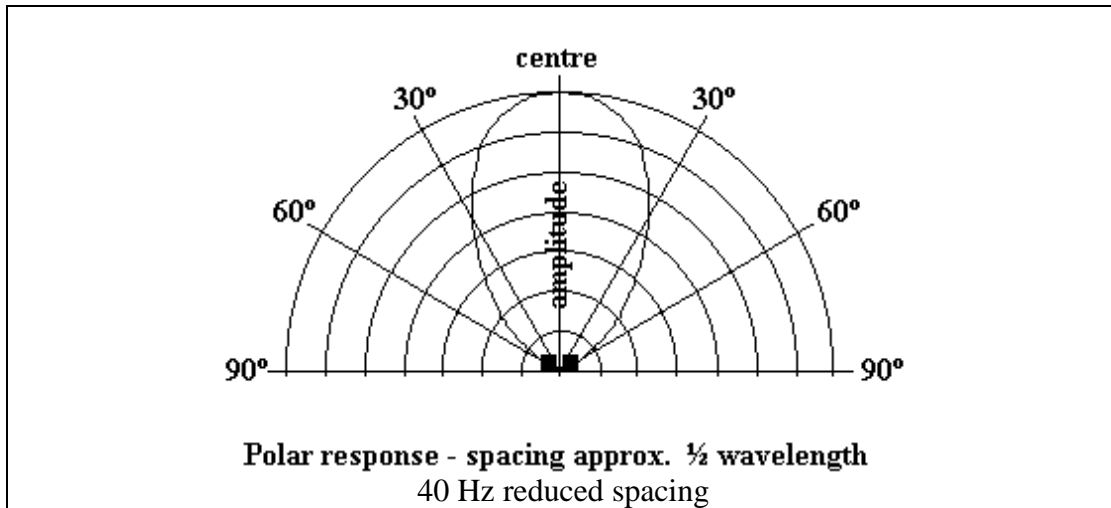

The above shows what happens at 40Hz if we reduce the spacing between the subwoofers to 4.3m.

We get better central coverage without 40Hz side lobes - adequate for long, narrow “shoe-box” venues but wider coverage would be required for most arenas.

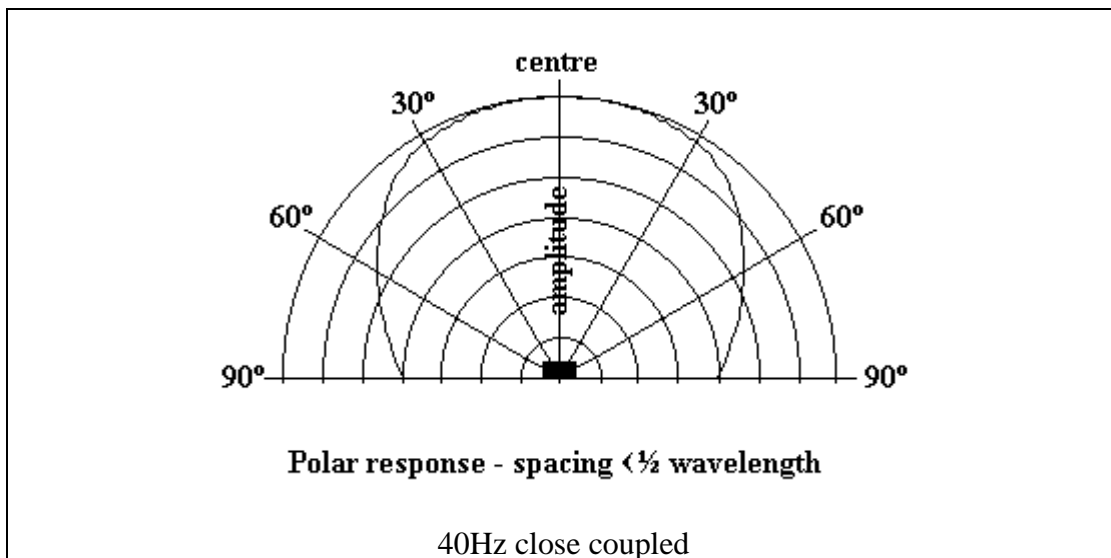

Close coupling would give a wider coverage at that frequency but the spacing could still give coverage irregularities at mid-bass frequencies due to the shorter wavelengths at higher frequencies.

The real world

Bass notes usually include harmonic components each with a different wavelength. Some will add giving an amplitude peak whilst others will subtract giving an amplitude dip. This will give tonal changes with listening position and emphasise particular notes and timbres.

In the following example, listeners over a wide central area will hear a warm bass note rich in harmonics whereas those around the sides (in line with the subwoofers at 90°) will hear less of the fundamental but more of the harmonics whose full wavelengths coincide with the subwoofer spacing.

Listeners in the 60° zone will hear the note at a reduced level and may be more aware of room reverberation because the direct-to-reverberation ratio would be poorer for that note. Other notes would give different effects.

In practice, these peaks and troughs can be smoothed out with additional fill systems.

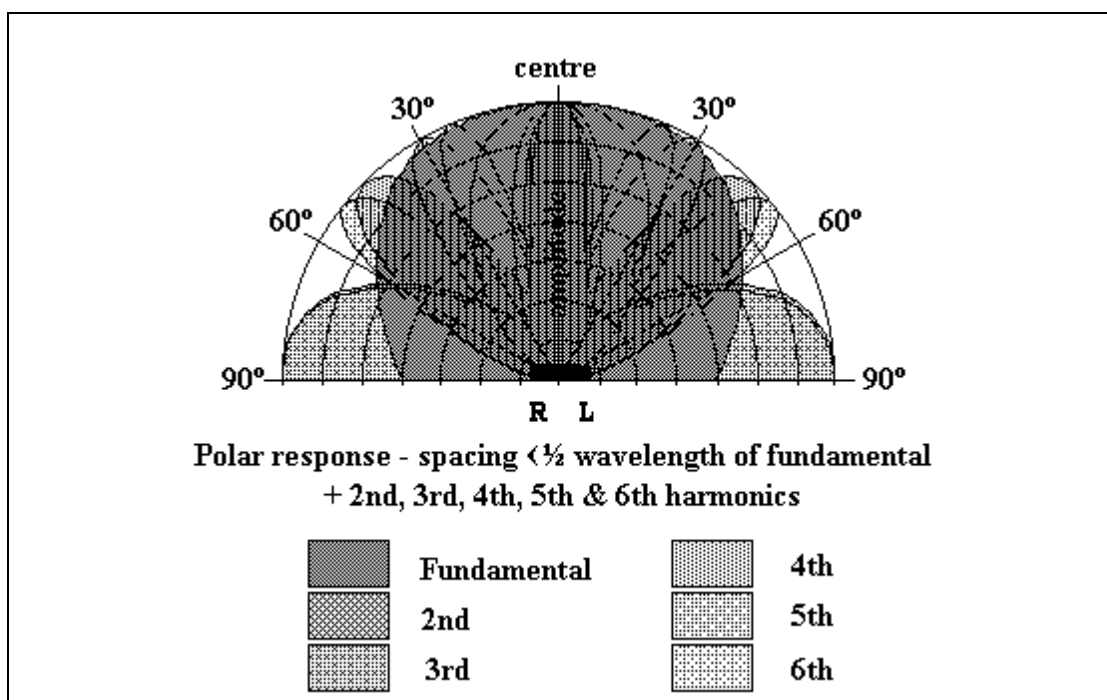

4.11 Electronic steering

It is possible to “aim” ground-stacks towards distant raked seating or balconies or away from problematic areas by electronically “tilting” the system using multi-channel digital delay lines.

The illustration below shows the basic schematic plus the staircase effect** (greyed out) produced by the progressive increase in drive delay from bottom to top.

****Important Note:**

The staggered stack (shown greyed out) illustrates the effect of electronic steering.

For safety reasons, never try to tilt or stagger a real subwoofer stack.

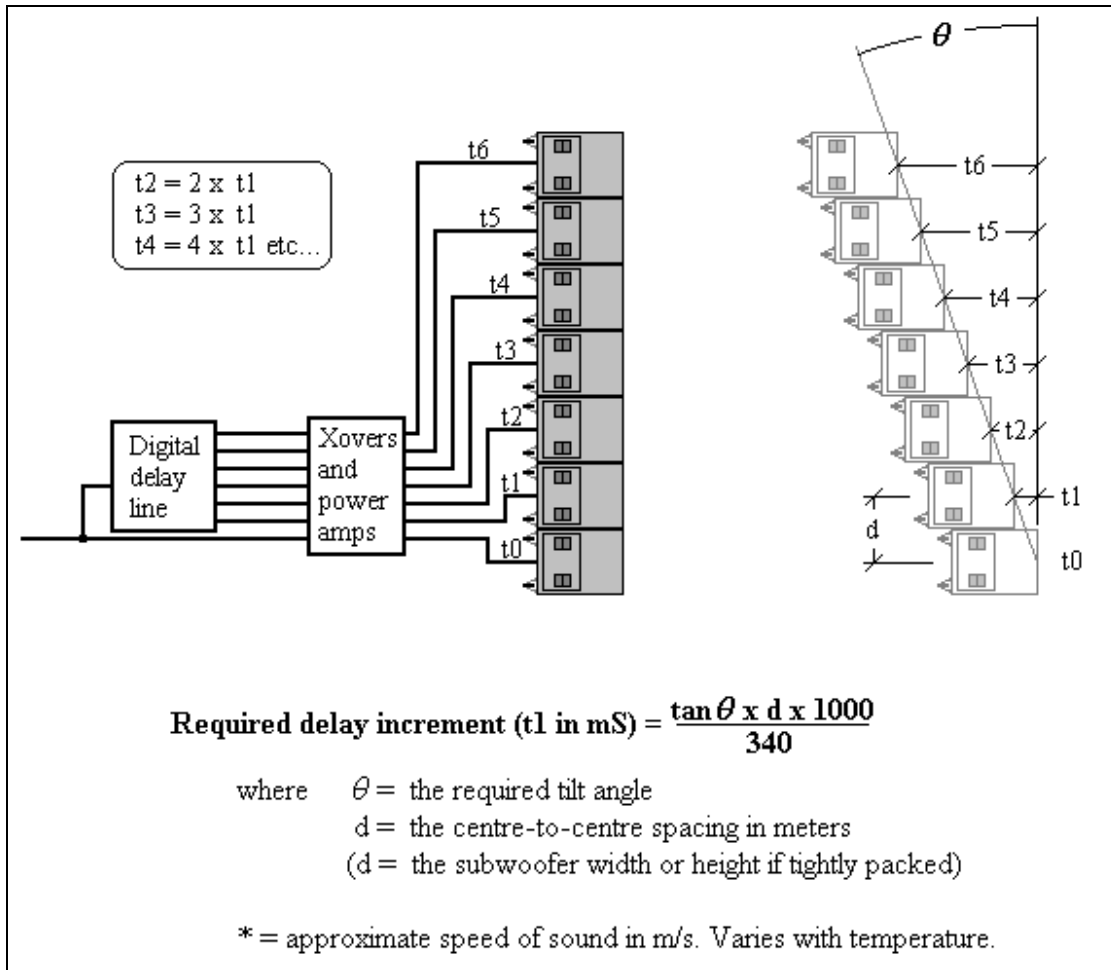

Note that it is important to keep the subwoofers tightly packed to avoid polar anomalies caused by spacing.

Procedure

The normal procedure is to measure the angle from the top of the vertical subwoofer stack to the highest/most distant seats (using an inclinometer) and to calculate the required delay increment with the formula shown.

Example

We wish to project bass/mid-bass punch to stadium balcony seats 30° higher than the top of our WSX stacks.

The WSXs are 572mm wide giving a centre-to-centre spacing of 0.572m.

$$\begin{aligned}
 \text{This means that our delay increment (in ms)} &= \frac{\tan 30^\circ \times 0.572 \times 1000}{340} \\
 &= 0.577 \times 0.572 \times 2.94 \\
 &= 0.97\text{mS or } 970\mu\text{S}.
 \end{aligned}$$

The following delay line taps would be required for the above system:

t0	=	0ms
t1	=	0.97mS
t2	=	1.94mS
t3	=	2.91mS
t4	=	3.88mS
t5	=	4.85mS
t6	=	5.82mS

Going further

It is possible to apply electronic shaping to horizontal arrays. For instance, it is common to use curved main clusters for smooth mid and high frequency coverage. Ground-based subwoofer arrays should follow the same curvature to maintain mid-bass crossover coherence but this is often difficult due to flat-fronted stage structures.

The following illustration shows an example of a flat-fronted horizontal array electronically splayed to emulate the greyed-out example shown.

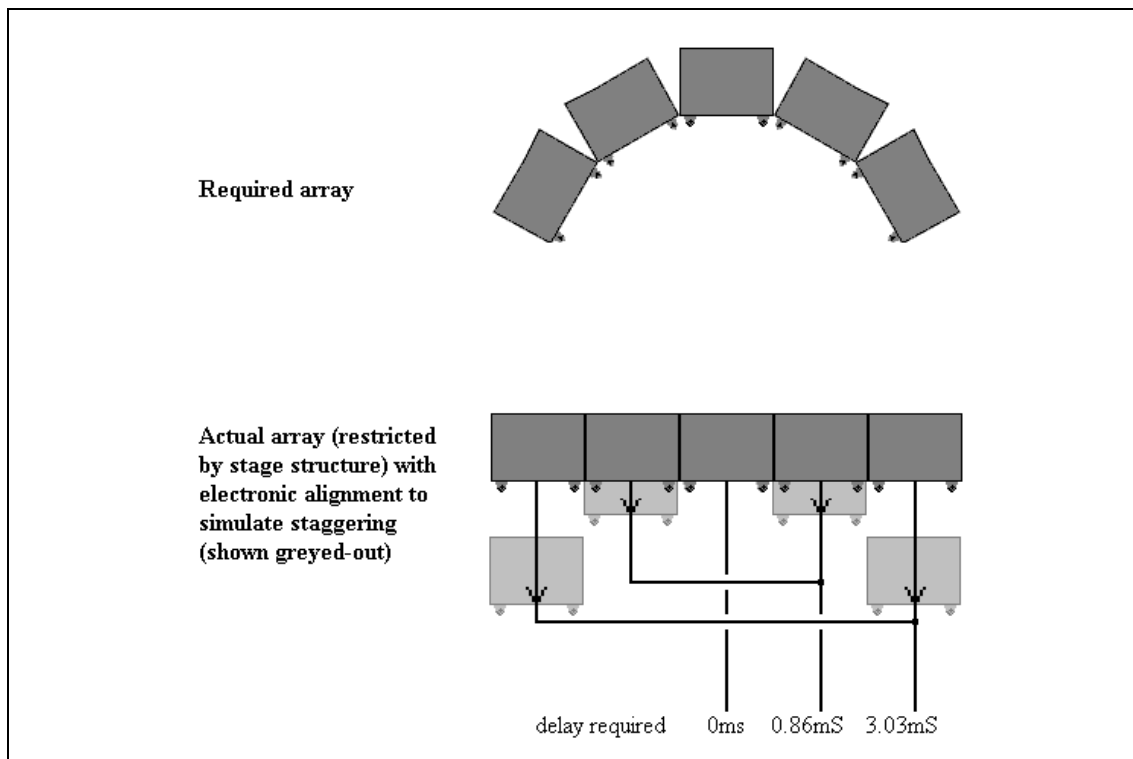

Martin Audio

Section 5

W8L Series Line Arrays

W8L, W8LC & W8LM

plus

W8LS and WLX Subwoofers



The Martin Experience

All rights reserved © 2007 Martin Audio Ltd. Subject to our terms and conditions.

Section 5

Application Guide

Wavefront W8L Series Line Arrays

W8L, W8LC & W8LM

plus

W8LS and WLX Sub-woofers

**Simply need controller and amplifier rack information?
Skip to sections *5.10, 5.11 & 5.12***

- 5.1 Introduction**
- 5.2 Specifications, outline drawings and performance plots**
- 5.3 Classic line array behavior**
- 5.4 How many do I need?**
- 5.5 ViewPoint™ 3.03 and System control**
- 5.6 Horizontal considerations**
- 5.7 Sub-woofers and Front Fills**
- 5.8 Climatic effects**
- 5.9 Delay Systems**
- 5.10 W8L Quick Start Guide**
- 5.11 W8LC Quick Start Guide**
- 5.12 W8LM Quick Start Guide**

General information

W8L Series Applications Guide Version 2 19th February 2004
Copyright by Martin Audio Ltd 2004; all rights reserved.

**Martin Audio Ltd, Century Point, Halifax Road,
Cressex Business Park, High Wycombe, Buckinghamshire. UK.**

The information presented in this document is, to the best of our knowledge, correct. Martin Audio Limited will not, however, be held responsible for the consequences of any errors or omissions.

Technical specifications, weights and dimensions should always be confirmed with Martin Audio Limited before inclusion in any additional documentation.

In our efforts to develop and improve our products we reserve the right to change the technical specification of our products without notice. Martin Audio Limited tries, whenever possible, to minimise the effects of product changes on equipment compatibility.

Wavefront W8L Series Line Arrays



5.1 Introduction

Martin Audio W8L Series line arrays are next generation line array systems which combine innovative loudspeaker design techniques with line array technology to produce a family of very powerful line arrays with extended frequency response, smooth coverage and maximum dynamic impact.

The series includes:

- ✚ The W8L 3-way full-range line array
- ✚ The W8LC 3-way compact line array
- ✚ The W8LM 3-way mini line array

The W8L and W8LC systems are fully horn-loaded tri-amplified systems. All sections are 8 ohms for easy paralleling in pairs.

The W8LM system combines direct radiating and horn-loaded cone drivers for low and mid frequency coverage with a horn-loaded high frequency section. The system may be bi-amplified (low/mid & high) or driven using a single amplifier channel via its internal 3-way passive crossover. W8LMs are 12 ohms for easy paralleling in threes or fours.

Where low frequency extension is required, W8L Series line arrays will integrate

with a range of Martin Audio sub-woofers including the Martin Audio W8LS direct radiating sub-woofer system or the Martin Audio WLX horn-loaded & ported (Hybrid[™]) sub-woofer system. See [Section 5.7](#).

W8L, W8LC and W8LM systems combine patentable driver loading techniques - researched and proven by Martin Audio over many years - with no-compromise vertically-coupled waveguides and true constant directivity horns to achieve a level of efficiency and coverage consistency not usually found in this popular format. W8L Series horns develop low curvature vertical wavefronts for smooth, comb-free coupling at practical vertical splay angles. A feature not possible with spaced, point-source drivers.

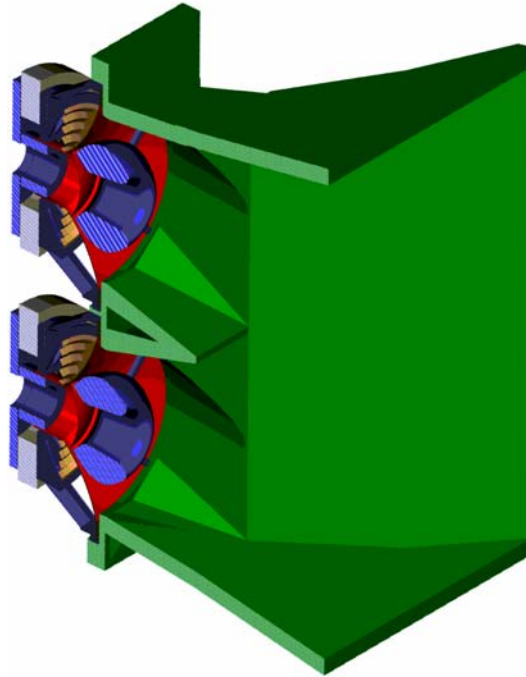

W8L Midrange section

Wavefront W8L Series line arrays feature integral, quick deployment flyware systems which allow progressive curvature columns of up to 16 cabinets to be assembled. By hinging at the front rather than the rear, the rigging system minimises gaps between the acoustic elements which would otherwise interfere with the line array effect.

Viewed from the side, W8L Series enclosures are trapezoidal in shape with 3.75° wall angles to allow arrays of varying curvature to be constructed. A series of inter-cabinet splay angles from 0° to 7.5° are selected by links at the rear of the enclosure. The 7.5° maximum splay angle allows tight curvature at the bottom of the array, obviating the need for dedicated down-fill systems. All hardware is integral and captive.



W8L rear rigging

Caution:

W8L Series columns should be rigged and flown by professional riggers or trained personnel under professional riggers' supervision. Flying professional loudspeaker systems is not a job for amateurs!

See the appropriate Flying System User Manual for further details.

5.2 W8L, W8LC, W8LM line array element specifications (single enclosure)

Specification	W8L	W8LC	W8LM
Type	Full-range 3-way line array element	Compact 3-way line array element	Ultra-compact 3-way line array element
Frequency Resp ($\pm 3\text{dB}$)	50Hz-18KHz	60Hz-18KHz	60Hz-18KHz
Hor Coverage (-6dB) (-10dB)	90deg 120deg	90deg 120deg	100deg 120deg
Vert Coverage (-6dB)	7.5deg	7.5deg	7.5deg
Driver complement	LF: 1 x 15" Hybrid tm horn-loaded cone drivers MF: 2 x 8" horn-loaded cone drivers HF: 3 x 1" horn-loaded compression drivers	LF: 1 x 12" Hybrid tm horn-loaded cone drivers MF: 2 x 6.5" horn-loaded cone drivers HF: 3 x 1" horn-loaded compression drivers	LF+MF: 2 x 8" cone drivers. 1 ported direct radiating LF, 1 Hybrid tm horn-loaded LF/MF. HF: 2 x 1" horn-loaded compression drivers
Rated Power	LF: 700W AES, 2800W peak MF: 400W AES, 1600W peak HF 200W AES, 800W peak	LF: 400W AES, 1600W peak MF: 200W AES, 800W peak HF 100W AES, 400W peak	Bi-amplified LF+MF: 400W AES, 1600W peak HF: 75W AES, 300W peak Passive 400W AES, 1600W peak
Sensitivity (spl at 1m, 1W)	LF: 106dB MF: 108dB HF: 113dB	LF: 103dB MF: 106dB HF: 109dB	Bi-amplified LF+MF: 100dB HF: 106dB Passive 99dB LF rising to 105dB HF
Max SPL (spl calc 1m)	LF: 134dB cont., 140dB peak. MF:	LF: 129dB cont., 135dB peak. MF:	Bi-amplified LF+MF: 125dB cont., 131dB peak. HF:

	134dB cont., 140dB peak. HF: 136dB cont., 142dB peak.	129dB cont., 135dB peak. HF: 129dB cont., 135dB peak.	125dB cont., 131dB peak. Passive 124dB cont., 130dB peak.
Nominal Impedance	LF: 8 ohms MF: 8 ohms HF: 8 ohms	LF: 8 ohms MF: 8 ohms HF: 8 ohms	Bi-amplified LF+MF: 12 ohms HF: 12 ohms Passive 12 ohms
Crossover	LF to MF: 220Hz active, MF to HF 2.5KHz active	LF to MF: 300Hz active, MF to HF 3KHz active	LF to MF: 300Hz passive, MF to HF 2.2KHz active or passive
Connectors	2 x Neutrik NL8 or PAcon sockets (Input & Link)	2 x Neutrik NL8 or PAcon sockets (Input & Link)	2 x Neutrik NL4 sockets (Input & Link)
Enclosure	Vertical trapezoid 3.75 deg top & bottom walls. Multi-laminate birch ply	Vertical trapezoid 3.75 deg top & bottom walls. Multi-laminate birch ply	Vertical trapezoid 3.75 deg top & bottom walls. Multi-laminate birch ply
Finish	Textured paint	Textured paint	Textured paint
Grille	Perforated steel	Perforated steel	Perforated steel
Dimensions			
mm	(W) 1314 (H) 490 (D) 755/855*	(W) 1000 (H) 367 (D) 550/683*	(W) 620 (H) 241 (D) 400
inches	(W) 51.7 (H) 19.3 (D) 29.7/33.7*	(W) 39.4 (H) 14.5 (D) 21.7/26.9*	(W) 24.4 (H) 9.5 (D) 15.75
(*incl wheelboard)			
Weight (incl. steel hardware)	127Kg (279lbs)	58Kg (128lbs)	24Kg (53lbs)

W8L & W8LS outline dimensions (W8L shown)

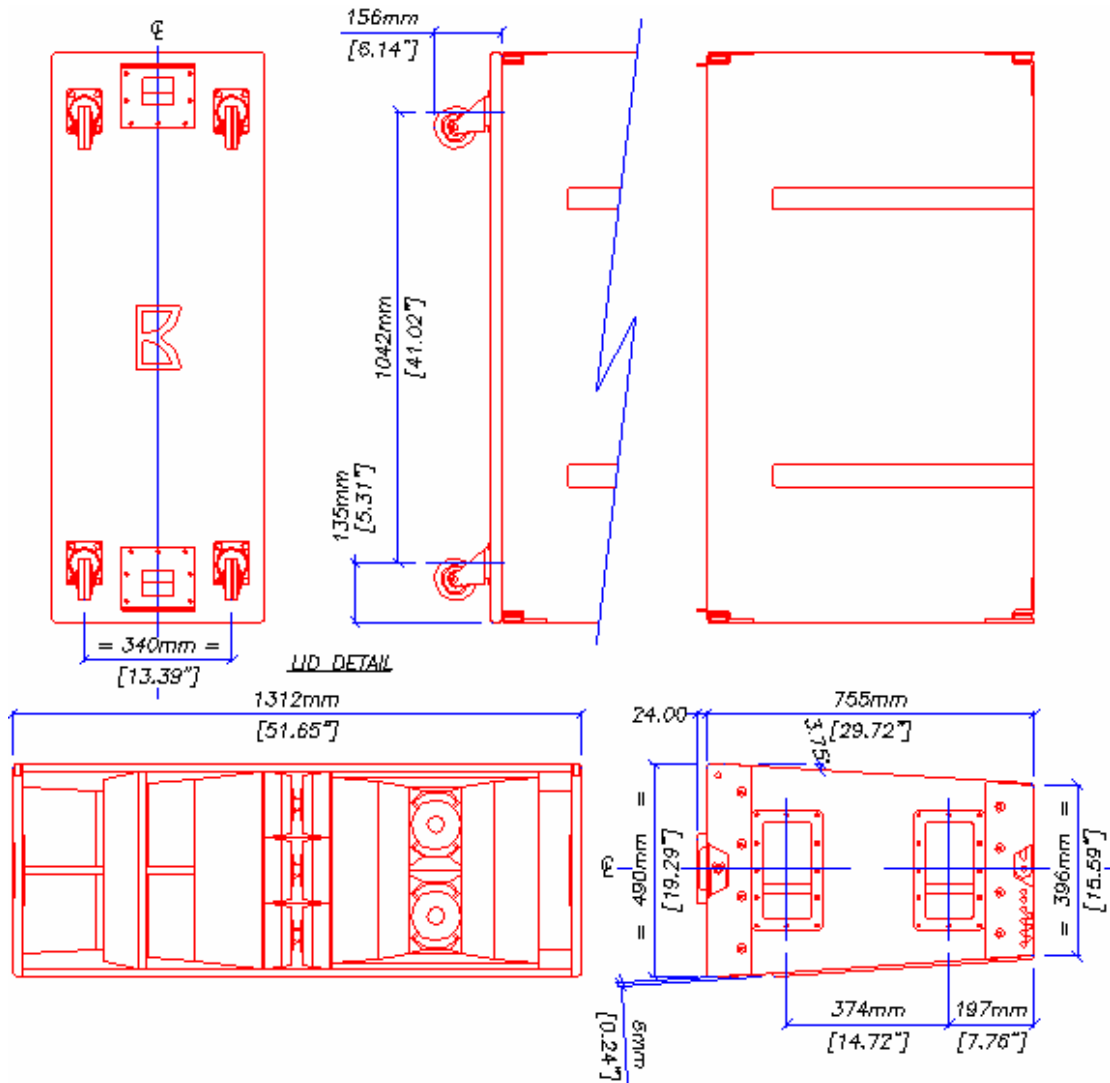

W8LC outline dimensions

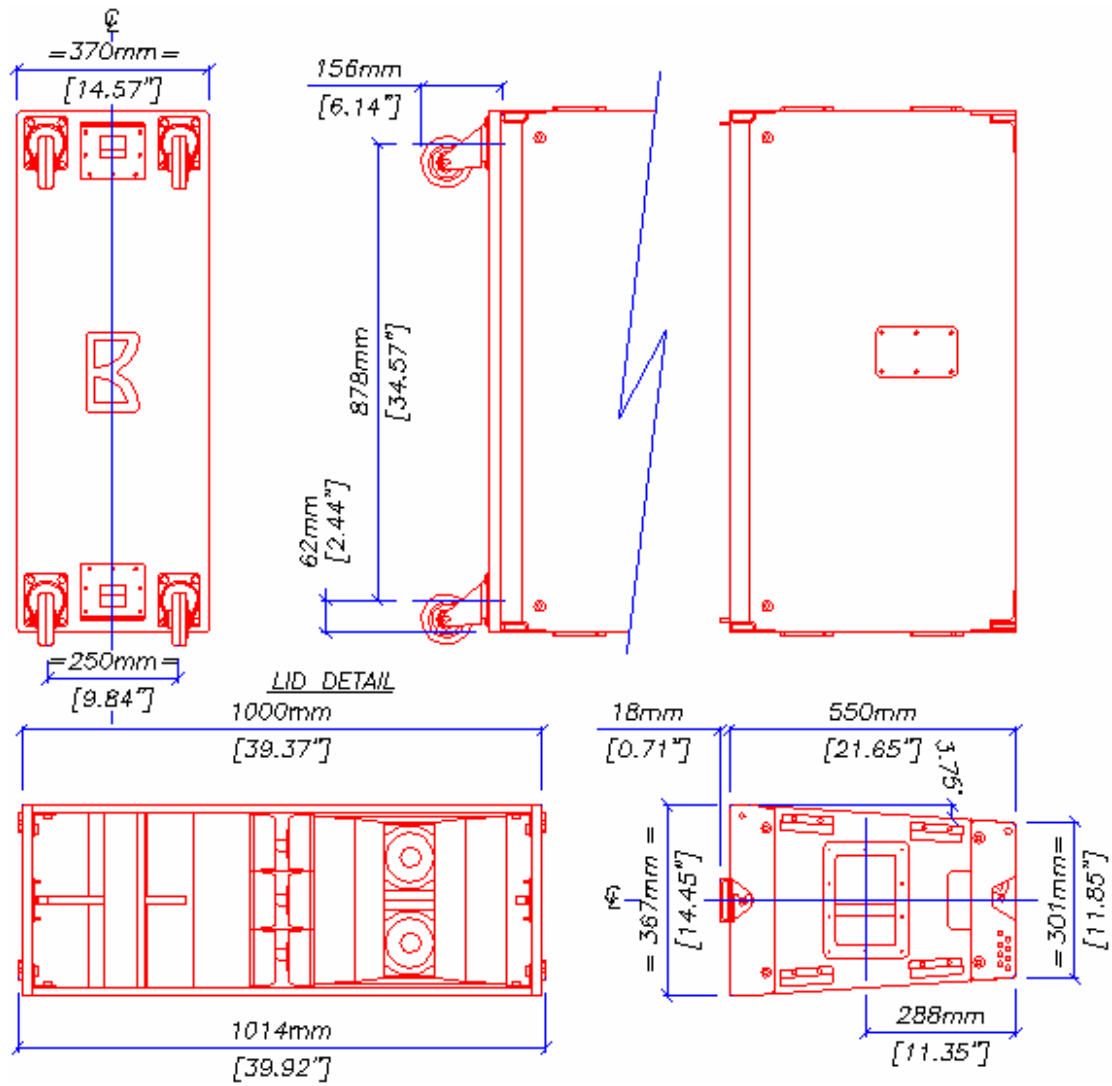

W8LM outline dimensions

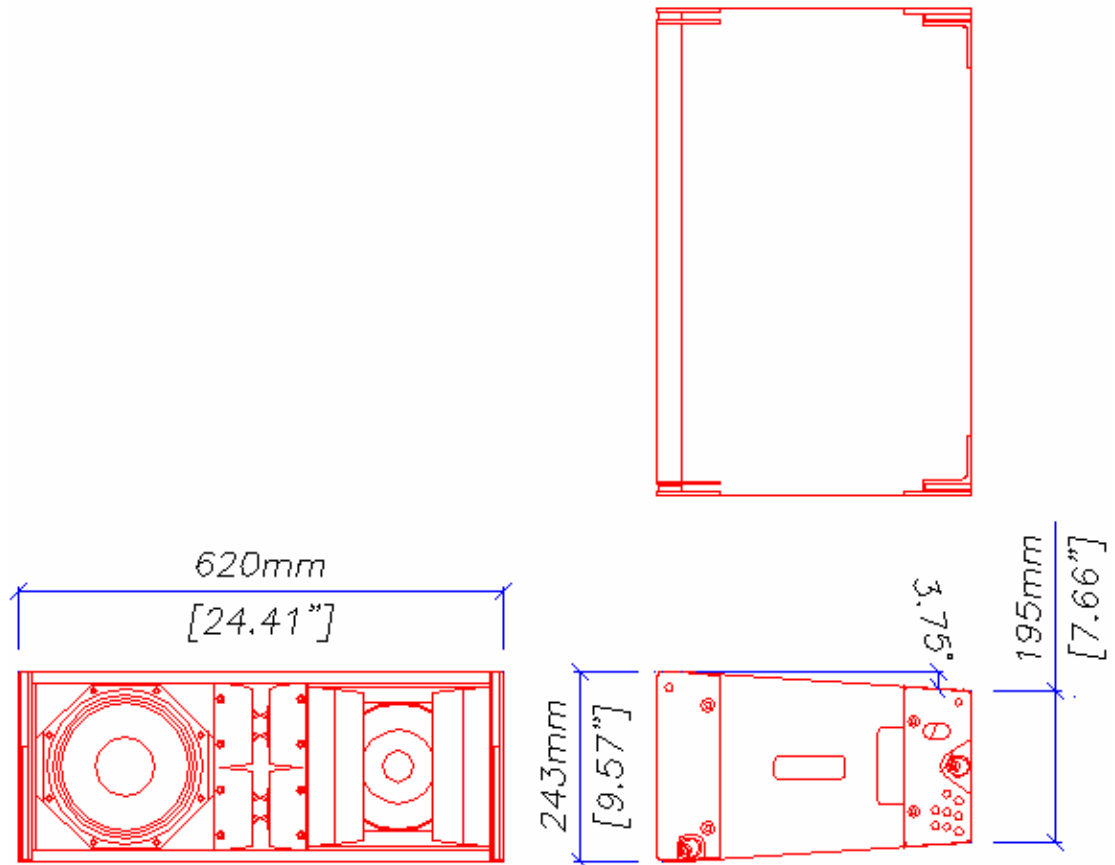

W8LX outline dimensions

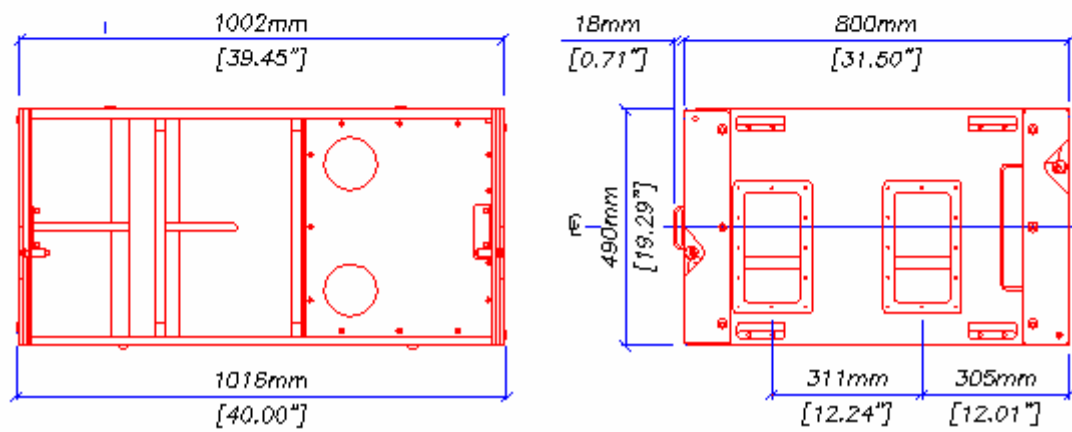
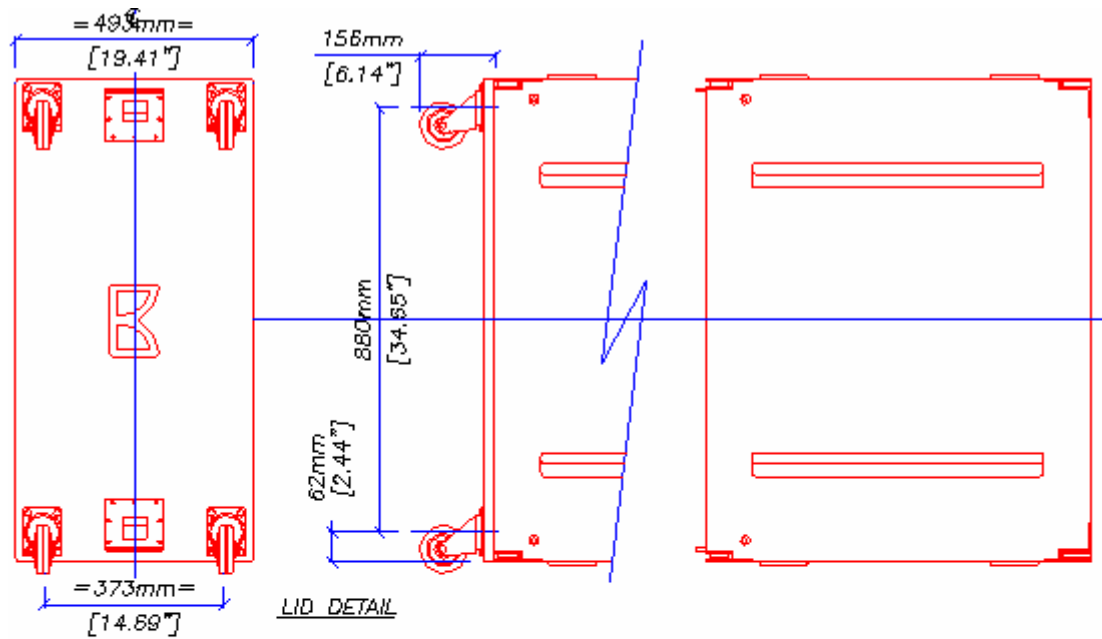

W8L polar plot

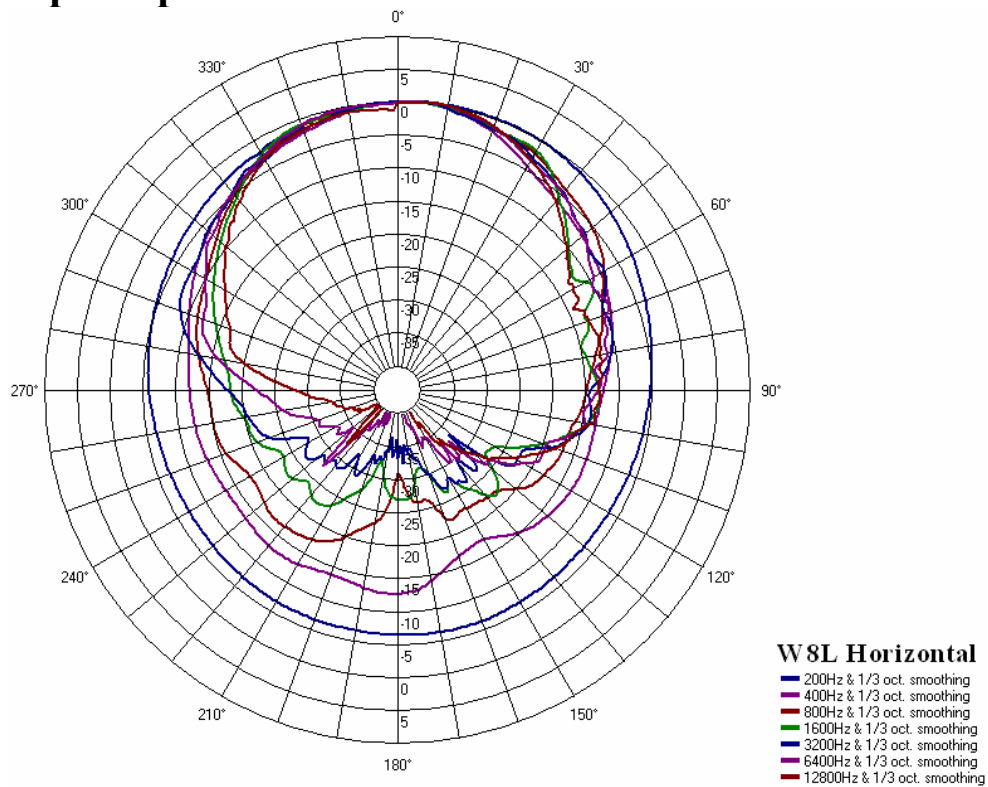

W8L beamwidth plot

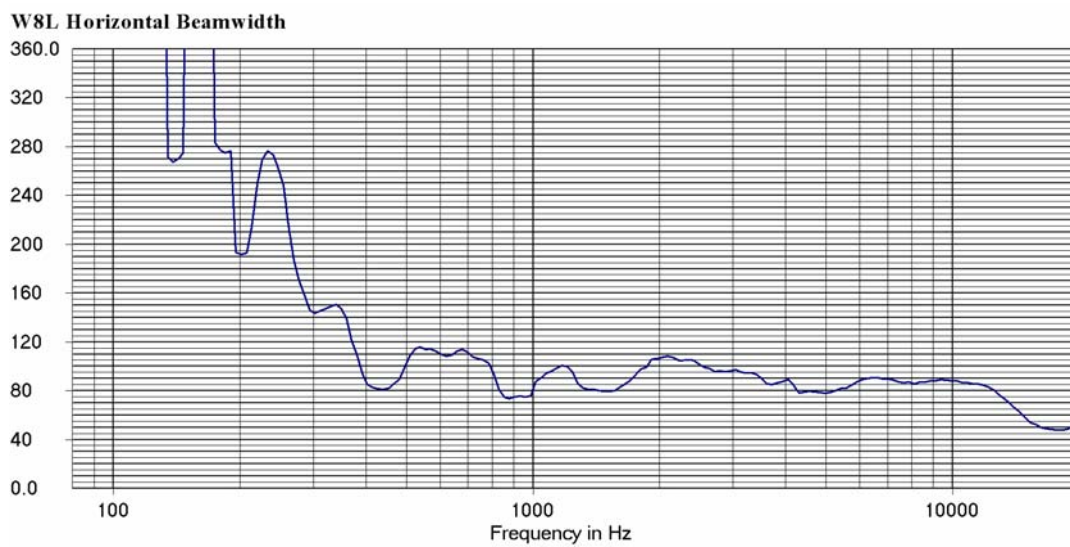

W8LC polar plot

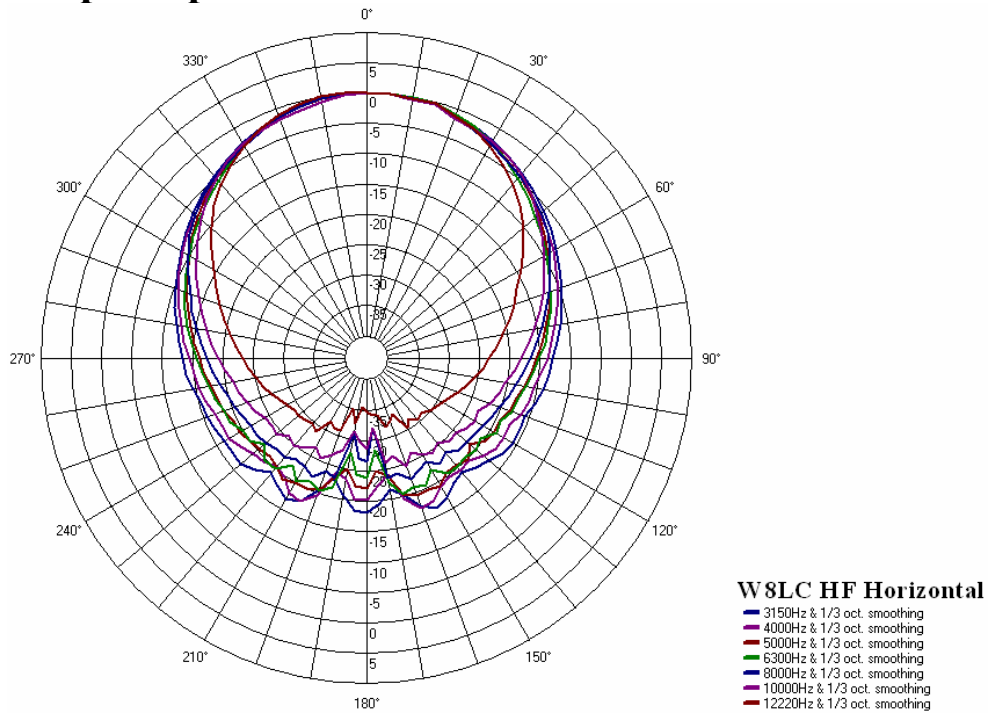

W8LC beamwidth plot

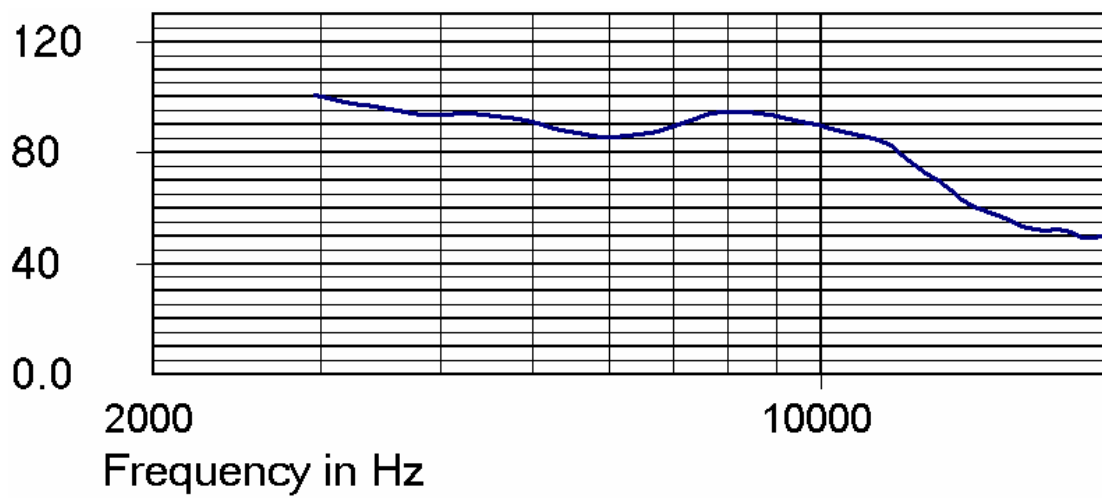

W8LM polar plot

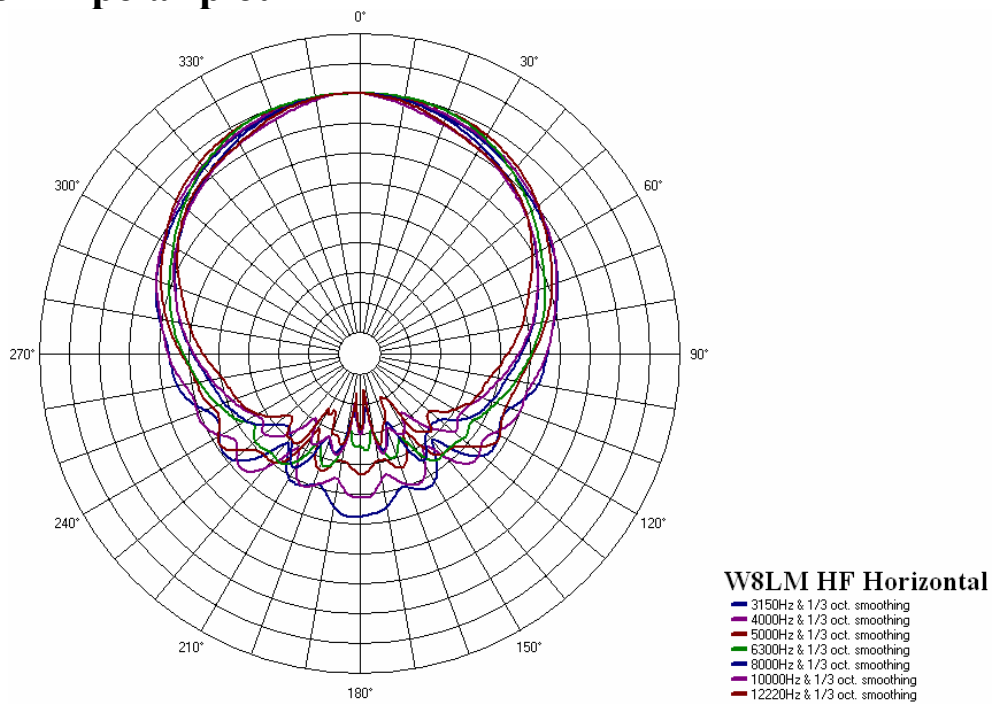

W8LM beamwidth plot

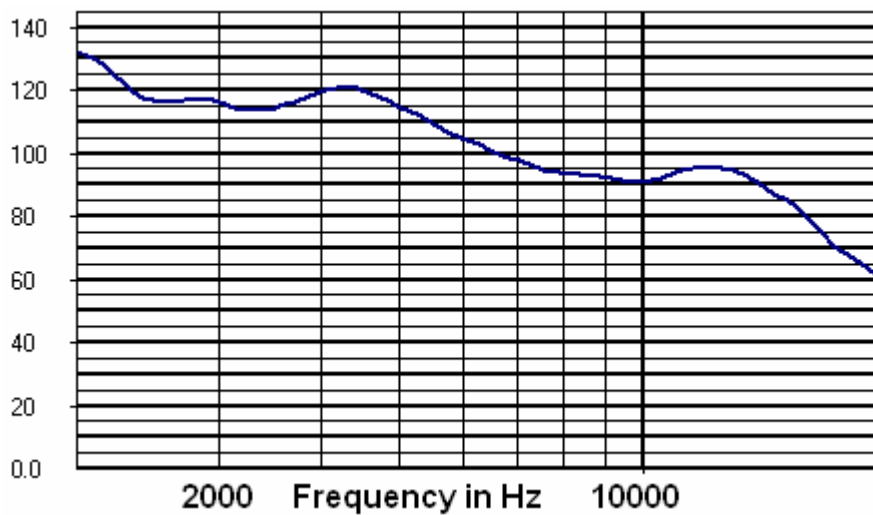

5.3 Classic line array behavior

Although the vertical coverage of a single point source may be wide, when arrayed in a straight line, multiple sources vector sum to form a tight vertical coverage pattern that narrows with increasing cluster height and frequency following the classic law for multiple source line arrays.

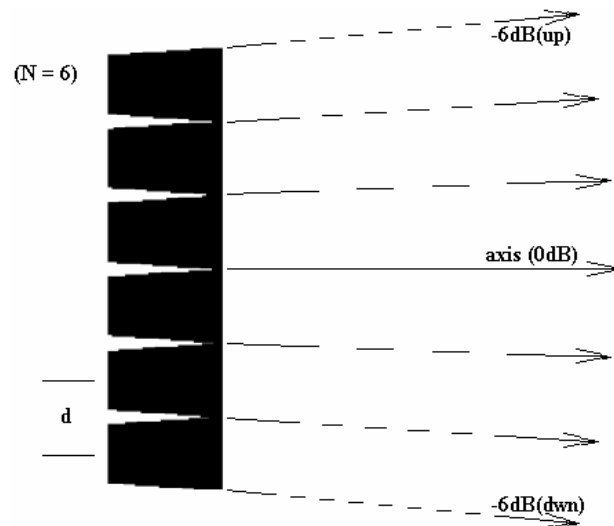

$$\text{Main coverage angle} = 2 \times \arcsin \left(\frac{0.61\lambda}{Nd} \right)$$

(between -6dB points either side of axis)

where λ = the sound wavelength in meters = $\frac{340^*}{\text{Frequency (Hz)}}$
 N = the number of W8Ls high
 d = the centre-to-centre spacing (= 0.49m if vertically tightpacked)

* = speed of sound (m/s). Varies with temp.

Arcsin = "the angle whose sin is..."

Nd = the total height of the column in meters

Propagation

Under normal conditions a wavefront moves through air at about 340m per second. Air gets its properties from the weight and speed of its molecules. Molecules of different weight (other gases maybe) or different velocity (that translates into temperature) will exhibit different speeds of sound. Motion of the sound source, the listener, or the air itself has no effect on the speed of sound, nor does the pressure of the air.

An impulse applies energy to the air. (This energy becomes a difference in pressure in front of and behind the wavefront.) As the front expands, the energy is spread over a larger and larger area, in a way suggested by the relationship between the radius and area of a sphere. The total energy stays the same, the area expands, so the energy in one unit of area decreases with the square of the distance from the source.

Point Sources

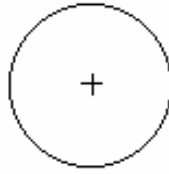

The effects of geometric spreading are well known for the three idealised sound sources; the point, line and plane. The behaviour of each is based solely on the assumption that, in a homogeneous medium, sound propagation from a single point source is purely spherical. Thus the sound energy in any particular direction is inversely proportional to the increasing surface area of the sphere. If SWL represents the continuous sound power output of the source measured at 1 metre, then at a distance of r metres (where r must always be divided by the measurement distance, which is usually 1m), the sound pressure level becomes;

$$SPL = SWL(\text{point}) - 10\log(4\pi r^2)$$

$$\text{and } I = W / (4\pi r^2)$$

This can be rewritten simply as;

$$SPL = SWL(\text{point}) - 20\log(r) - 11$$

which is known as the standard *inverse square law* for point sources.

For a point source it represents a 6dB reduction in sound pressure level per doubling of distance.

If the ground is quite hard and reflective, compensation must be made for these ground reflections. In this case 11 is replaced by 8dB.

Line Sources (e.g. line array loudspeakers)

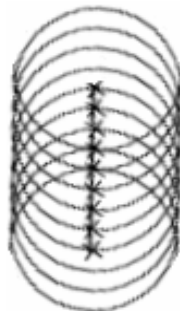

Classic line and plane sources can then be considered to consist of an infinite number of evenly distributed individual point sources. The overall behaviour is then found by integrating the individual effects of each point source over the full length or area. In the case of an ideal line of infinite length, the results approximate that of purely cylindrical propagation. Thus the sound energy in any perpendicular direction is inversely proportional to the increasing circumference of the cylinder. Using the same nomenclature as above, the sound pressure level becomes;

$$SPL = SWL(\text{line}) - 10\log(4 p r)$$

For a line source this results in only a 3dB reduction in sound pressure level per doubling of distance in the nearfield . . .

But note: This nearfield -3dB/doubling distance varies with frequency and straight line array length

Plane Sources

For a plane source (e.g. a flat wall of sub-woofers), integrating an infinite number of point sources distributed in two dimensions produces a flat surface. Thus, propagation away from a planar source approximates a plane wave. The sound energy of each point source is therefore assumed to propagate in a straight line perpendicular to the plane, meaning that no geometric spreading need be considered as there is no change in distributed surface area as the wave propagates.

Obviously there will be some at the edges of an finite planar source, however, at close range near the centre of the plane there is no diminution with distance. Therefore, the sound pressure level can be written as:

$$SPL = SWL(\text{plane})$$

Unfortunately, most real line and plane sources are of a finite size. This means that their overall behaviour becomes a definite integral. Considering this, it is easy to imagine that, at a very great distance or very small size, both sources will ultimately approximate an ideal point source.

This suggests that for such sources, there is a gradual change in behavior as a function of both size and distance.

A straight line array will maintain it's low loss characteristics (3dB decrease in spl per doubling of distance + air absorption) for a distance that depends on it's length with respect to the wavelength of the sound being projected. Beyond this distance the line effect breaks down and the spl characteristic weakens from -3dB/doubling of distance plus air absorption to -6dB/doubling of distance plus air absorption. This transition distance depends on the square of the straight line array's length and is proportional to frequency following the generally accepted formula:

$$\text{Transition distance} = \frac{\text{line length}^2 \times \text{frequency}}{2 \times \text{speed of sound}}$$

Where distances and length are given in metres and the frequency is in Hertz.

The speed of sound is approximately 340metres/second but varies with temperature.

Simplified, this means that you need a long line array to project low-mid frequencies efficiently. Doubling the line array length will almost quadruple its low-mid frequency nearfield throw. See **Section 5.4**.

Stacked general purpose horns vs low curvature line array elements

The following illustrations compare the poor coverage characteristics of vertically stacked general purpose horns with the properly designed low curvature horns found in the W8L Series line arrays.

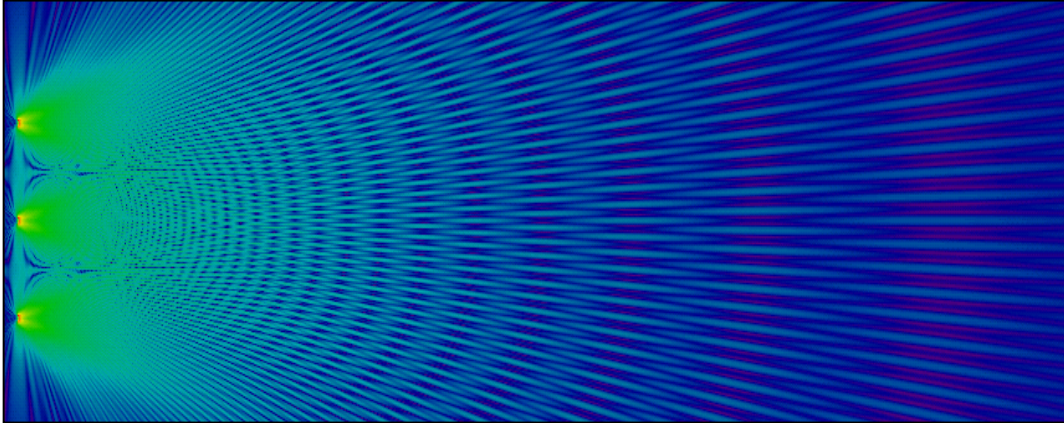

Three 30° horns 1m apart, 8kHz

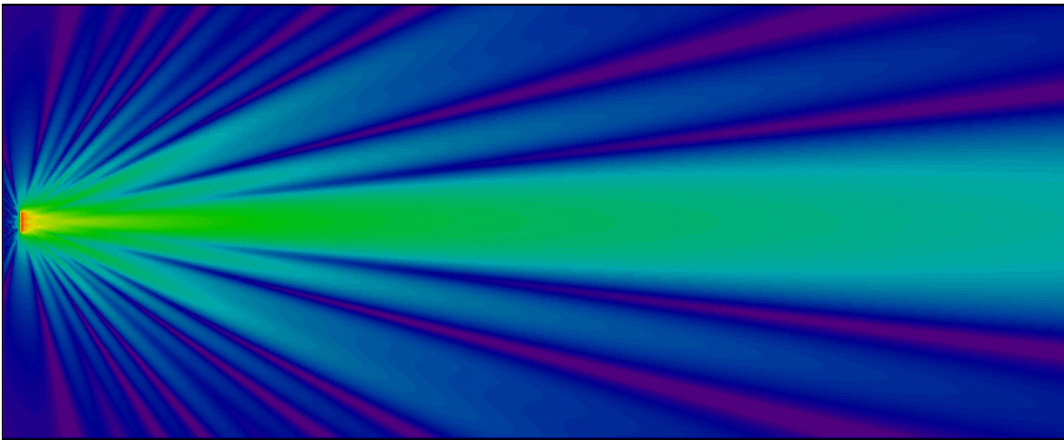

Three tightly arrayed low curvature horns at 8kHz

Vertically spaced, wide coverage horns will have hot spots directly in front of each horn and will comb (add or subtract depending on the wavelength and relative propagation times) in the mid and far field. Tightly arrayed low curvature horns project more coherently. As the number of low curvature line elements is increased forward projection strengthens and the side lobes decrease.

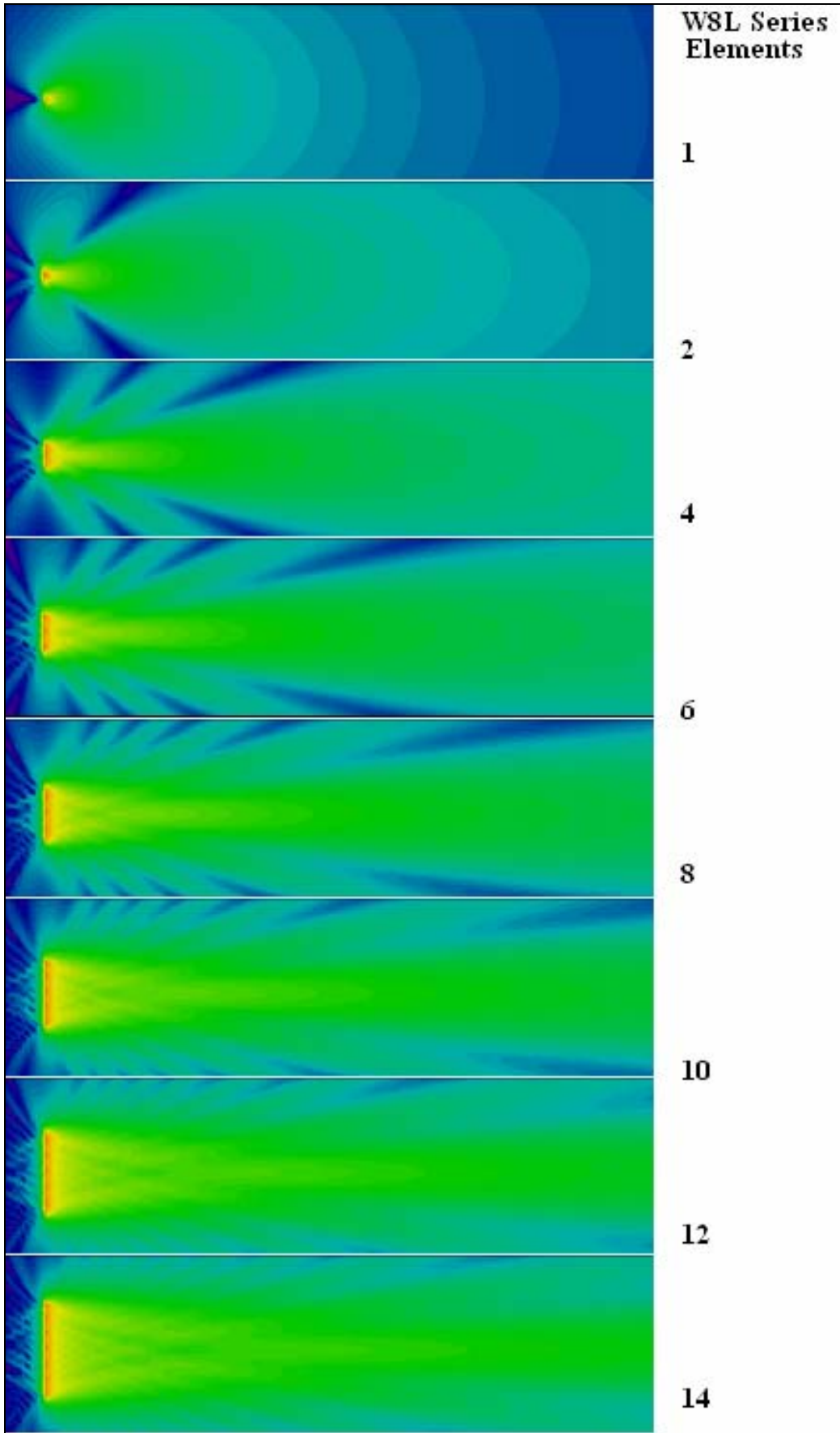

The listener hears the vector sum of more and more cabinets as he moves further away from a straight line array. These increasing contributions partially compensate for the normal reduction in sound pressure with distance from source.

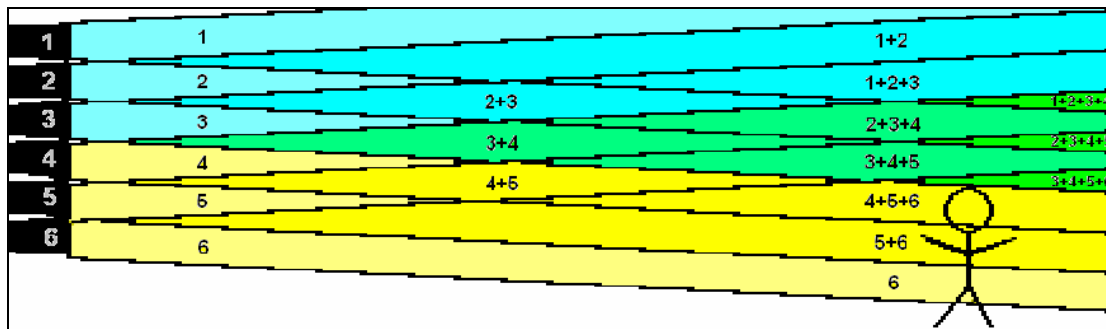

Note that farfield spl levels will increase towards the centre of the array where more elements add.

W8L Series

The classic explanation of line array behavior assumes omni-directional point source drive elements that must be positioned within $\frac{1}{4}$ wavelength at their highest operating frequency for coherent summation. Martin Audio designs comprise directional horn-loaded sections. This closely coupled horn technique modifies the equations allowing greater driver spacing. See our Institute of Acoustics, Reproduced Sound 2003 paper, *Advances in Line Array Technology for Live Sound*.

Note that our mid and hf designs do not try to emulate a dead straight ribbon. Practical loudspeaker columns must have vertical coverage patterns tailored to suit the audience size and shape and our line array systems have been designed with this in mind. The W8L Series are deliberately designed to produce slightly curved vertical wavefronts - enough to allow up to 7.5° of vertical splay to be introduced between boxes but not enough to affect straight line performance.

Progressive Curvature arrays

Straight columns (0° splay angles) produce far-field high-mid frequency sound pressure levels that increase approximately 6dB for every doubling of W8L quantities but, as inter-box splay angles increase, the vector sum of multiple W8Ls decreases through 3dB for a 3° splay to 0dB (no summation) at 7.5° . This **Progressive Curvature** provides smooth level coverage without amplifier channel trimming for most applications.

Martin Audio's ViewPointtm software calculates the optimum progressive curvature for a given audience area. The progressive curvature produces a more consistent frequency response from the front rows to the rear seats than often used J-shaped arrays having a straight, long throw section at the top and a curved lower section. An over-angular J-shaped array acts like a foreshortened straight array above a point source array and creates vertical lobes that result in irregular coverage.

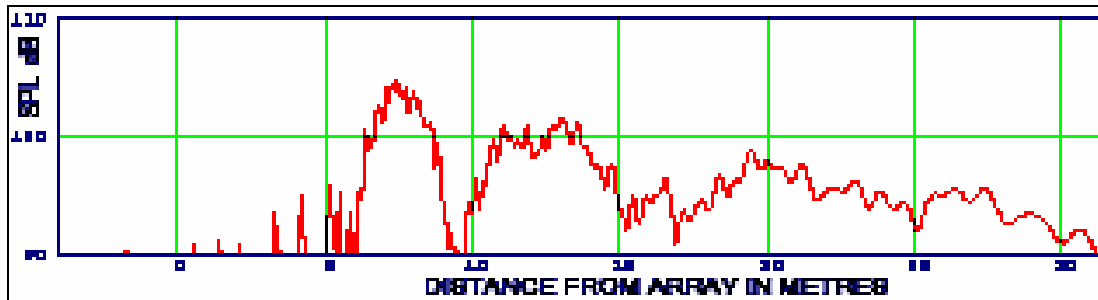
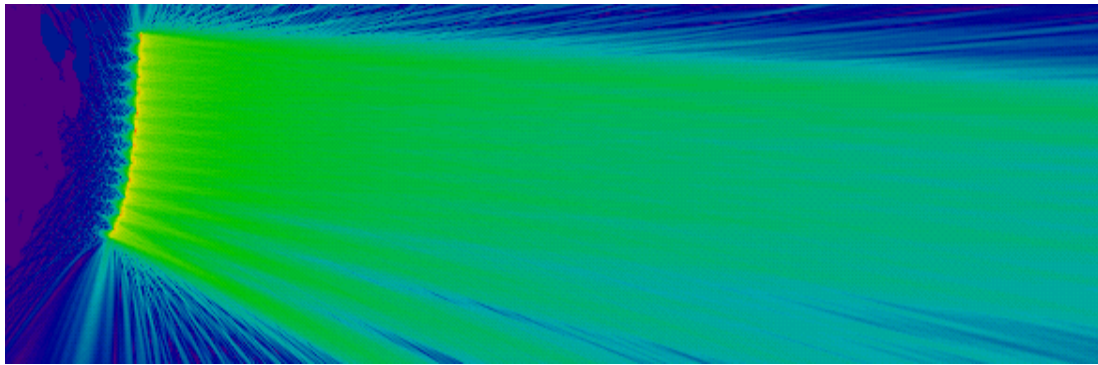

Irregular coverage from a J-Shaped Array

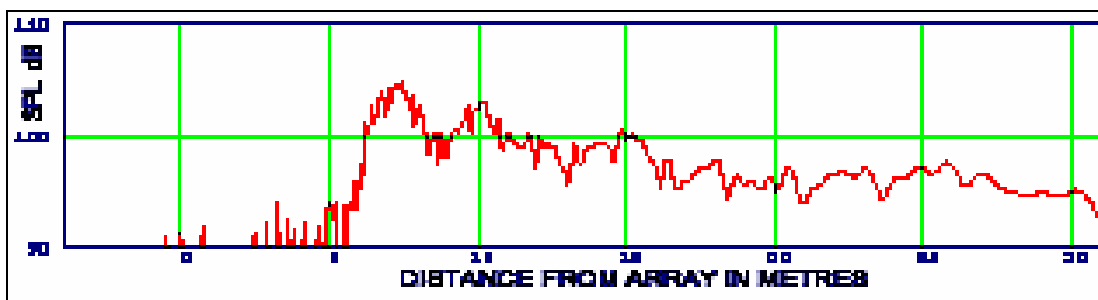
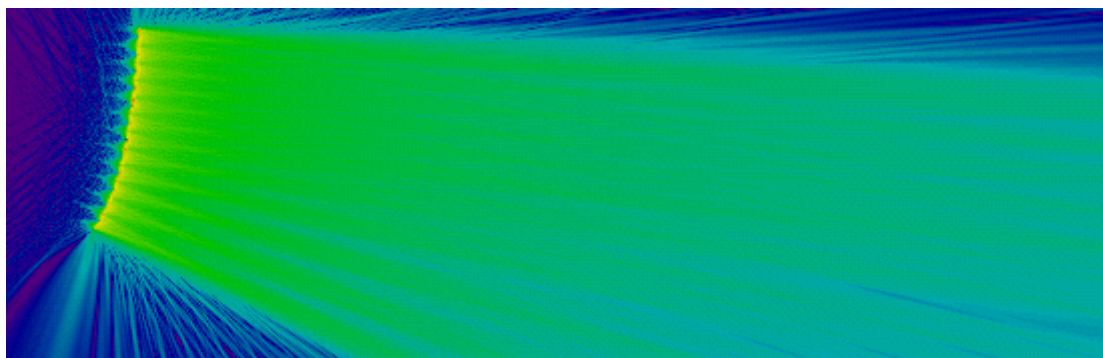

Smoother coverage from a Martin Audio *Progressive Curvature* Array

ViewPointtm calculates the maximum summation point (near the top of a progressively curved array) and aims this towards the furthest listening area. A progressive curvature array's HF coverage weakens dramatically above the maximum summation point so this point is regarded as the **Coverage Stop** – see [Section 5.5.12](#)

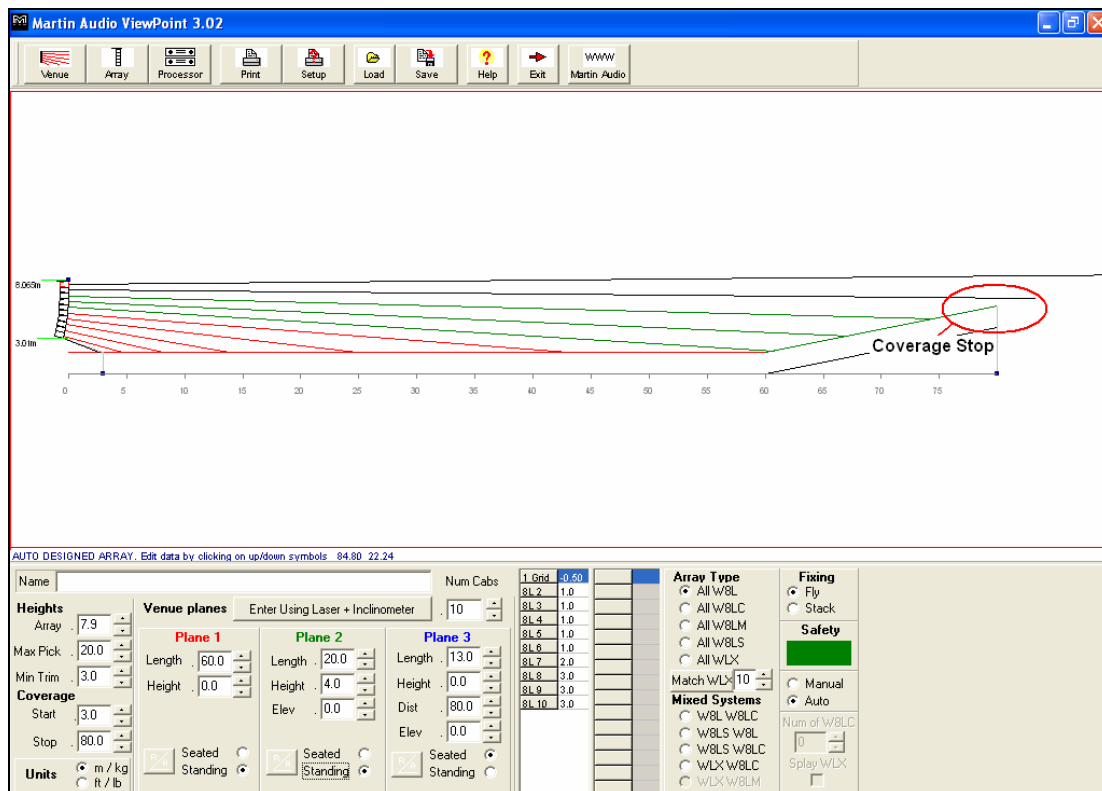

5.4 How many do I need?

There are four major factors to take into account when specifying line array columns for a specific application.

- 1) ***Will I need delays?*** Very important - see [Section 5.9](#).
- 2) ***Spectral Balance*** - the minimum column length required for spectral balance over the full audience distance or just beyond the 1st delays.
- 3) ***Maximum SPL*** - the number & model required to achieve maximum spl.
- 4) ***Horizontal Coverage*** – see [Section 5.6](#).

5.4.1 Spectral Balance

Users new to line array technology can be confused by items 2 & 3. The minimum column length for spectral balance cannot be reduced simply because the band is a quiet traditional folk combo. A short line array column would project only mid frequencies to the far field. It would lack warmth and sparkle as it would not be long enough for the line affect to take effect at low mid frequencies and may not have the headroom at high frequencies. Boosting the system's LF and HF would simply cause too much bass in the front seats and a lack of headroom at HF.

As we saw earlier, a straight line array will maintain it's low loss characteristics (3dB decrease in spl + air absorption per doubling of distance) for a distance that depends on the line length with respect to the wavelength of the sound being projected.

$$\text{Transition distance} = \frac{\text{line length}^2 \times \text{frequency}}{2 \times \text{speed of sound}}$$

The transition distance is not the system's maximum throw. It is the distance that the system's near-field characteristic will reach – or, if you prefer, the 3dB per doubling of distance attenuation range (ignoring air absorption). Beyond this distance the attenuation rate will increase to 6dB/doubling of distance (ignoring air absorption). The transition distance can be thought of as the distance that the line array's advantageous low attenuation rate will reach.

The distance from the stage to the furthest seats in a typical football stadium is in excess of 120m. The line array advantage (the effect of moving the near-field characteristic closer to the audience) will be proportional to frequency and the square of the line length so it will be less for short arrays at low frequencies.

It is very important that you use a line array that is long enough for the low-mid frequency projection to follow the superior mid and high frequency projection out far enough for mid-high air absorption to have a balancing effect.

The following curves show the spectral balance of 4 and 12 W8L cabinets vs distance taking air absorption into account for about 40% relative humidity.

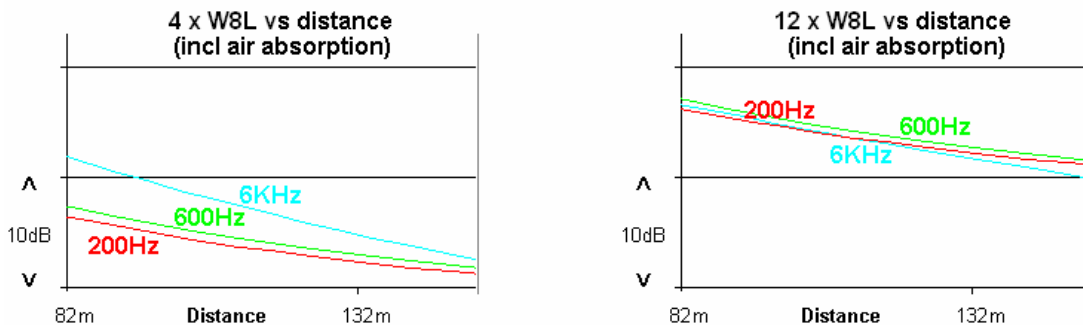

The 4 x W8L system low mid projection is less efficient than its upper mid projection because too few cabinets have been used for the line to be effective at low frequencies. The smaller system would project clean vocals but it would sound thin – lacking warmth and authority.

The 12 x W8L system 200Hz, 600Hz and 6KHz responses are closer together (and, obviously, at a higher amplitude). The longer line has "kicked" the low-mid frequencies out further so that they can keep up with the mid and high frequencies.

A 12 x line array provides excellent spectral tracking over typical stadium distances whilst providing the extra high frequency headroom required to partially counter air absorption.

Note that, as air absorption increases, upper mid frequency characteristics tend to track lower mid characteristics with high frequencies tailing off.

Model and quantity for a balanced spectral response

A spectrally balanced system will provide a useful far-field response within an octave of the product's LF and HF specification.

A system's LF response may be enhanced by extending the effective column length with sub-woofers flown above or stacked immediately below the array.

HF air absorption is the dominant factor beyond 50m. Be cautious about specifying very long throw systems where the air may be dry (e.g. for outdoor events during hot, dry weather, for desert regions or for venues with warm air heating). See [Sections 5.8 & Section 5.9](#).

The following chart indicates the minimum quantity and model for the required throw. The chart is based on applications experience and line array physics as it is currently understood.

Quantity	W8L (no subs)	W8LC (no subs)	W8LM (no subs)
Cabinets arrayed with 2° or less inter-cabinet splay	Throw (in meters) for spectral balance	Throw (in meters) for spectral balance	Throw (in meters) for spectral balance
4	25	18	12
6	40	29	18
8	60*	40	25
10	80*	58*	32
12	100*	70*	41
14	130**	88*	50*
16	155**	105**	60*
* Assumes relative humidity 50% or higher ** Assumes relative humidity 70% or higher Lower humidity will cause unacceptable HF absorption.			

Note: The cabinet quantities refer to low curvature arrays or the low curvature (upper) sections of progressively curved arrays.

The following ViewPointtm examples indicate the quantity of cabinets that can be regarded as contributing to the system's mid and high frequency far-field characteristic.

Example 1

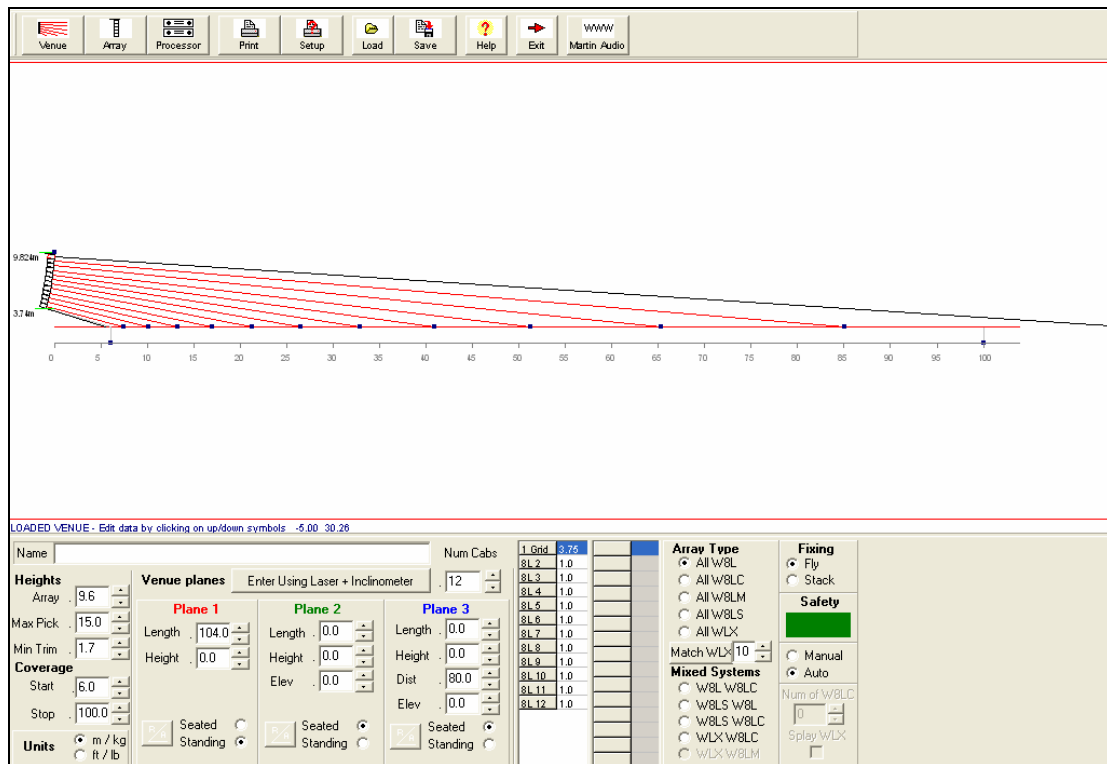

12 x W8L (at 1°) per side festival system in side wings for 100m throw

Example 2

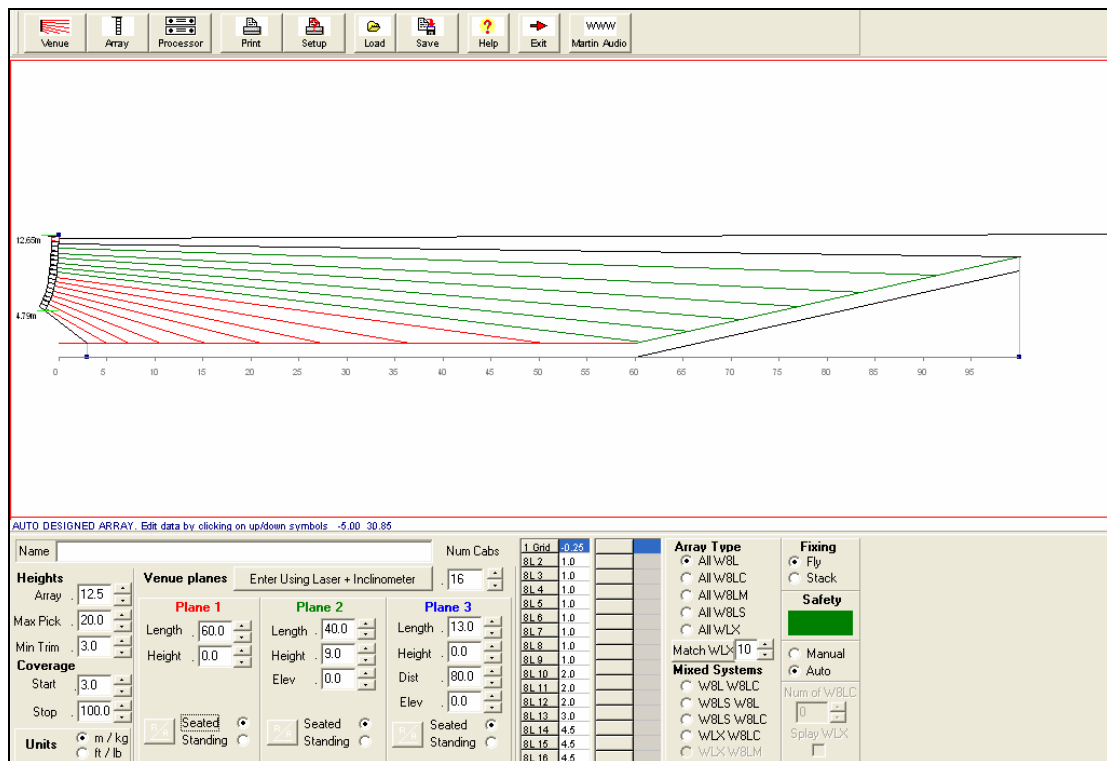

16 x W8L per side arena system
Upper 12 cabinets at 1 & 2° for 100m throw

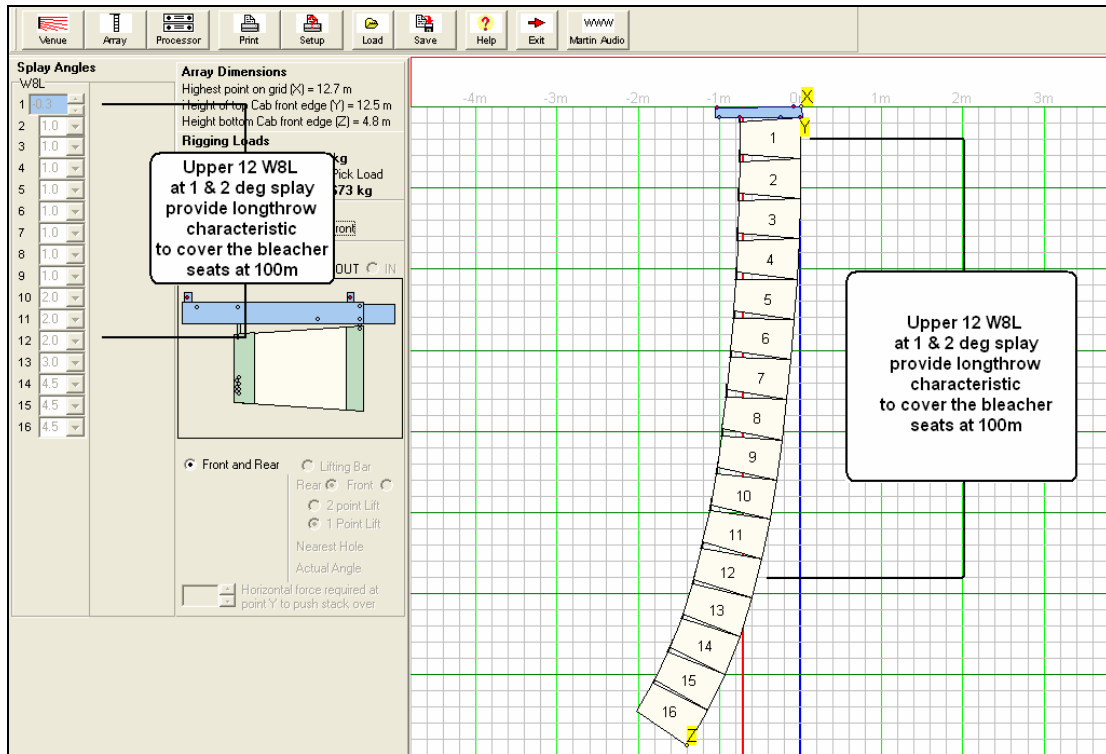

Example 3

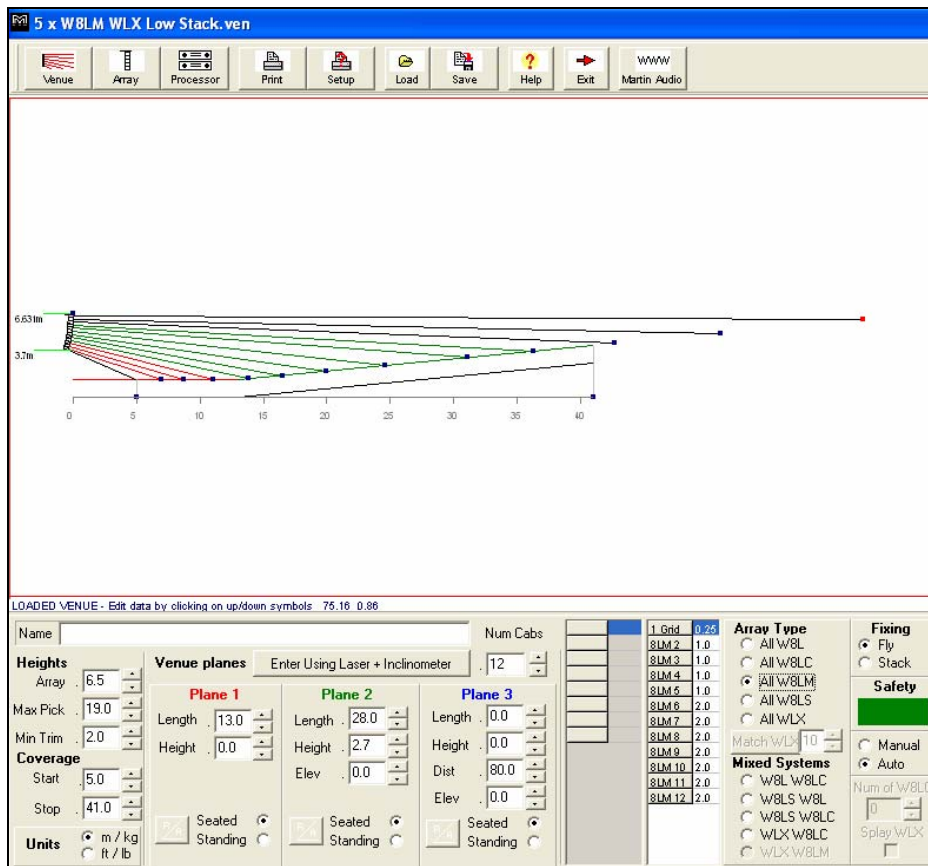

12 x W8LM per side 41m concert hall system

5.4.2 Maximum far-field on-axis SPL Calculations

Simplified maximum far-field on-axis spl estimates for a single column may be made using the following simple arithmetic and look-up tables . . .

Far-field Sound Pressure Level (spl) = A minus B minus C

where **A = the effective source spl referred to 1m distance**
B = the radial attenuation with distance
C = excess air attenuation

(A) - The effective source spl is calculated for far-field estimates only (in practice, large array outputs do not integrate as close as 1m).

This “source spl” will depend on the W8L Series model’s maximum spl, the number of cabinets and the splay angle between the cabinets. W8L Series cabinets have a nominal vertical MF & HF coverage of 7.5° so calculations have been restricted to 8 cabinets for 1° splay and 4 cabinets for 2° splay on the assumption that progressive curvature arrays start with minimal splay at the top for far-field projection, increasing towards the bottom. 0° (straight) arrays are calculated for up to 16 cabinets as curvature losses are not applicable.

See look-up table below.

(B) - Radial attenuation is the reduction in sound pressure due to the radial expansion of the wavefront. This attenuation varies from 3dB per doubling of distance in the nearfield to 6dB per doubling in the farfield and depends on the length of the array.

See look-up table below.

(C) - Excess air attenuation is caused by air absorption. It is heavily dependent on humidity and temperature and is worse at mid and high frequencies.

See look-up table below.

Value of A

Quantity (splayed at 0°)	W8L Max dB spl cont. pk	W8LC Max dB spl cont. pk	W8LM Max dB spl cont. pk
1	134 140	129 135	125 131
2	140 146	135 141	131 137
4	146 152	141 147	137 143
6	150 156	145 151	141 147
8	152 158	147 153	143 149
10	154 160	149 155	145 151
12	156 162	151 157	147 153
14	157 163	152 158	148 154
16	158 166	153 159	149 155

Effective source spl (referred to 1m) vs model & quantity

Quantity (splayed at 1°)	W8L Max dB spl cont. pk	W8LC Max dB spl cont. pk	W8LM Max dB spl cont. pk
1	134 140	129 135	125 131
2	140 146	135 141	131 137
4	145 151	140 146	136 142
6	148 154	143 149	139 145
8	150 156	145 151	141 147

Effective source spl (referred to 1m) vs model & quantity

Quantity (splayed at 2°)	W8L Max dB spl cont. pk	W8LC Max dB spl cont. pk	W8LM Max dB spl cont. pk
1	134 140	129 135	125 131
2	139 145	134 140	130 136
4	143 149	138 144	134 140

Effective source spl (referred to 1m) vs model & quantity

Value of B

Distance from array ↓	1m array (2xW8L, 3xW8LC or 4xW8LM)	2m array (4xW8L, 5xW8LC or 8xW8LM)	4m array (8xW8L, 11xW8LC or 16xW8M)	6m array (12xW8L or 16xW8LC)	8m array (16xW8L)
16m	15dB	12dB	12dB	12dB	12dB
32m	21dB	15dB	15dB	15dB	15dB
64m	27dB	21dB	18dB	18dB	18dB
128m	33dB	27dB	21dB	21dB	21dB
256m	39dB	33dB	27dB	24dB	24dB

Radial attenuation vs line array length & distance at 6KHz
(inter-cabinet splay = 1° or less)

Value of C

Distance from array ↓	25% R.H.	50% R.H.	75% R.H.	100% R.H.
16m	2dB	1dB	0.7dB	0.6dB
32m	4dB	2dB	1.4dB	1.2dB
64m	8dB	4dB	2.8dB	2.3dB
128m	16dB	8dB	5.6dB	4.6dB
256m	32dB	16dB	11dB	9.2dB

Excess air attenuation vs distance at 6KHz (20°C at sea level)

Stereo Approximation

The above figures are for a single column. Centre-field maximum spl may increase by approximately 3dB at mid frequencies for stereo systems and may approach a 6dB increase at low frequencies.

Horizontal off-axis attenuation

Off-axis figures will be less than single column on-axis figures at mid and high frequencies as follows:

Horizontal off-axis attenuation	W8L (± off-axis angle)	W8LC (± off-axis angle)	W8LM (± off-axis angle)
-3dB	22.5°	22.5°	25°
-6dB	45°	45°	50°
-10dB	60°	60°	60°

Note! Gusting side winds may affect these figures erratically.

5.5 ViewPoint™ (Version 3.03)

Contents

- 5.5.1 Introduction
- 5.5.2 Installing ViewPoint™
- 5.5.3 Using ViewPoint™
- 5.5.4 Entering venue data
- 5.5.5 Coverage start and stop
- 5.5.6 Array type
- 5.5.7 Array fixing
- 5.5.8 Designing a flown array
- 5.5.9 Stacked systems
- 5.5.10 Venue name
- 5.5.11 Editing ViewPoint™ designs
- 5.5.12 Frequently asked questions
- 5.5.13 Using ViewPoint™ for systems with sub-woofers
- 5.5.14 Manual array editing
- 5.5.15 Array page
- 5.5.16 Processor page

- 5.5.17 Saving a design
- 5.5.18 Loading a design
- 5.5.19 Printing ViewPoint™
- 5.5.20 Exiting the programme
- 5.5.21 ViewPoint™ support

ViewPoint™ (Version 3.03)

5.5.1 Introduction

ViewPoint™ software will automatically calculate the splay angles of a W8L Series array and will indicate the optimum controller (processor) preset and amplifier patch information once venue and array data has been entered. You can print out array, venue, rigging and patch information and save your work to disk.

Please Note:

ViewPoint™ produces sonically accurate results based on high resolution loudspeaker data and the audience coverage but you must use the amplifier patch and one of the controller preset indicated for accurate Band Zoning and smooth coverage.

- 1) **The controller preset names shown on ViewPoint™ correspond to the preset names on our DX1, XTA DP226 or XTA AudioCore data files.**
- 2) **Please ensure that your controllers are running our standard reference presets for the W8L Series loudspeaker in use.**
- 3) **Users should start with a unity gain, zero delay, flat frequency response controller input section and revert back to our standard presets at the beginning of each venue setup to avoid using settings contaminated with room equalization from a previous gig.**

5.5.2 Installing ViewPoint™

ViewPoint™ is supplied in a zip folder which contains a setup executable file *ViewPoint 3.03.exe*.



Double-click on this and follow the on-screen prompts.

5.5.3 Using ViewPoint™

Once you have installed ViewPoint™, it will be visible as a shortcut in *All Programs* via your Windows *Start* button.



A single click on the *viewpoint v3.03* tab will open the following page:

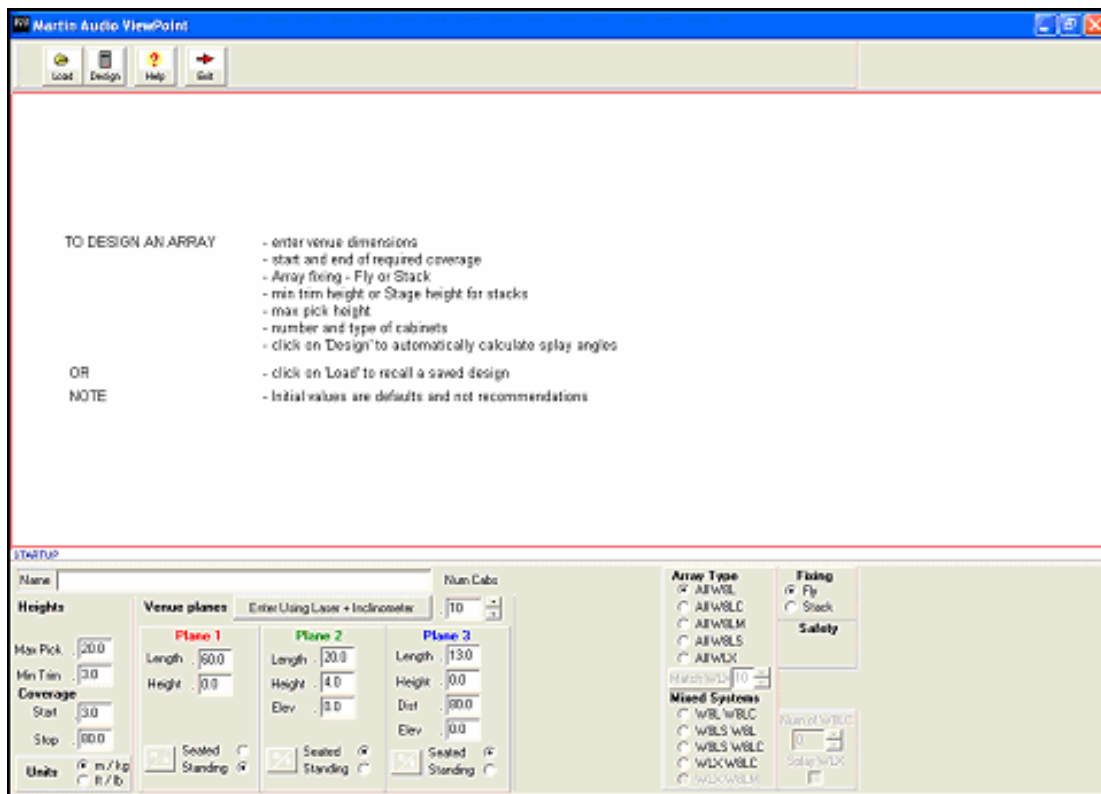

ViewPoint™ will indicate splay angles and controller presets for these flown systems:

- ✚ **W8L (Full-range line array)**
- ✚ **W8LS (Sub-woofer)**
- ✚ **W8LC (Compact line array)**
- ✚ **W8LM (Mini line array)**
- ✚ **WLX (Sub-woofer)**

and these flown combinations of the above:

- ✚ **W8LS (Sub) above W8L**
- ✚ **W8L above W8LC**
- ✚ **W8LS (Sub) above W8LC**
- ✚ **W8LC above W8LM**
- ✚ **WLX (Sub) above W8LC**
- ✚ **WLX (Sub) above W8LM**

and the following ground-stacks:

-  W8L
-  W8LC
-  W8LM

5.5.4 Entering venue data

Choose metric or imperial units using the **Units** box on the **Venue** page.

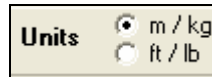

Click on the button adjacent to the units that you would like to use.

Note: if you enter dimensions in one unit system and then click on the button of the other system all dimensions will be converted, i.e. 1m will become 3.28ft.

PLEASE NOTE!

ViewPointtm is designed as a line array design aid. It does not claim to be a high resolution drawing programme.

It indicates optimum line array curvature based on simple audience dimensions that may be gathered from basic venue drawings or from a quick on-site survey.

For best results, planes should be used as follows:

Plane 1 is used to simulate the main floor area from the stage to a rear bleacher or boundary.

Plane 2 is used to simulate any audience continuation behind Plane 1 (e.g. a rear bleacher) from the end of the main floor to furthest and highest seat below Plane 3.

Plane 3 is used to simulate the furthest/highest audience area.

Example:

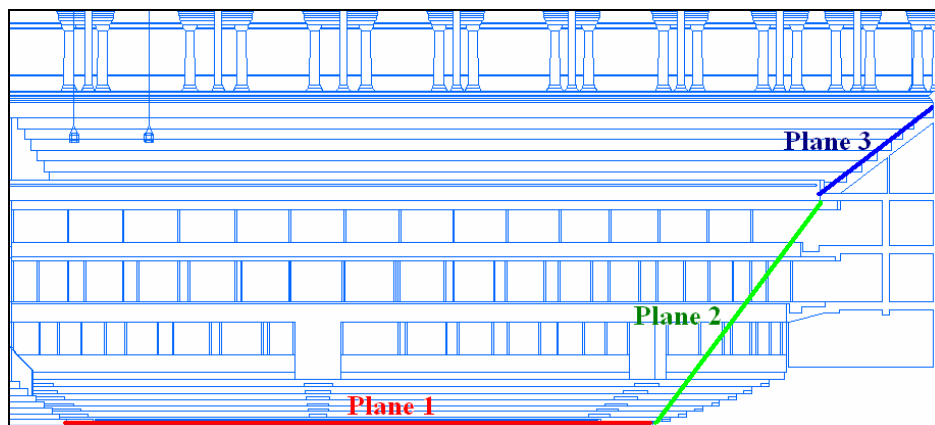

Plane 1, plane 2 and plane 3 decisions

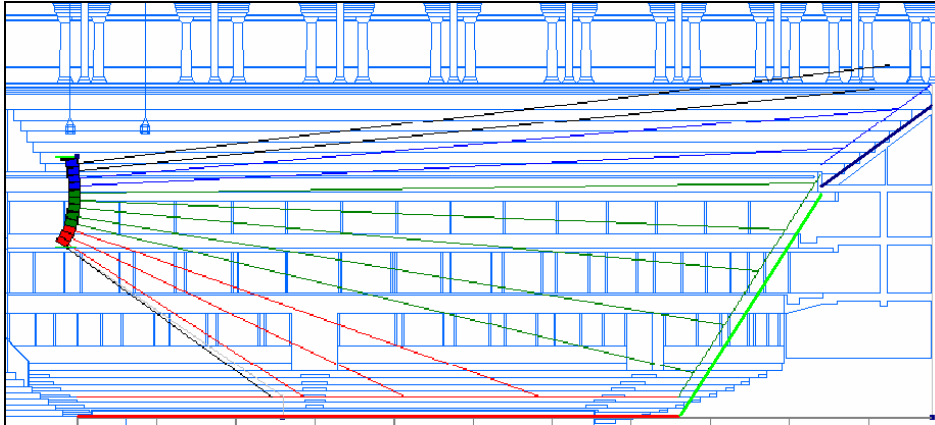



Overlaid ViewPoint™ display (front fills not shown)

There are 3 methods for entering venue Dimensions.

5.5.4.1 Direct

If you have the venue plans available then this is the easiest method:

Enter the height, length and elevation of up to three planes.

Plane 1	Plane 2	Plane 3
Length . <input type="text" value="60.0"/>	Length . <input type="text" value="20.0"/>	Length . <input type="text" value="13.0"/>
Height . <input type="text" value="0.0"/>	Height . <input type="text" value="4.0"/>	Height . <input type="text" value="0.0"/>
	Elev . <input type="text" value="0.0"/>	Dist . <input type="text" value="80.0"/>
	Elev . <input type="text" value="0.0"/>	Elev . <input type="text" value="0.0"/>
<input type="checkbox"/>  Seated <input type="radio"/> <input checked="" type="radio"/> Standing <input checked="" type="radio"/>	<input type="checkbox"/>  Seated <input checked="" type="radio"/> <input checked="" type="radio"/> Standing <input type="radio"/>	<input type="checkbox"/>  Seated <input checked="" type="radio"/> <input type="radio"/> Standing <input type="radio"/>

- ✚ For all planes **Length** refers to the horizontal length of that plane
- ✚ For all planes **Height** refers to the height of the rear of the plane. Plane 1 height can be negative or positive.
- ✚ For planes two and three **Elev** refers to the elevation (height) of the front of the plane.
- ✚ For plane three **Distance** relates to the actual distance from the front of the array to the start of the third plane.
- ✚ For all planes selecting **Seated** or **Standing** places ear level at 1.4 or 1.8m above the respective plane.

5.5.4.2 Individual Plane R-A

To enter diagonal distance (R) and angle of elevation (A) instead of length (X) and height (Y) click on the symbol in the bottom left hand corner of a plane.



The following pop-up window will appear.

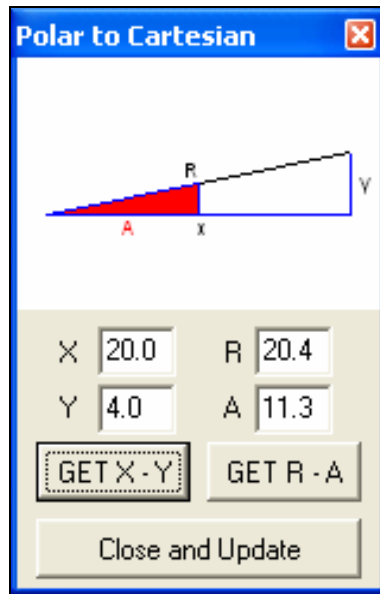

Enter R and A in the right hand boxes and click on **Get X-Y**.

Click on **Close and Update** to copy the X and Y data in to the Length and Height boxes and close the pop-up window or click on the x symbol in the top right hand corner of the pop-up window to close it without copying.

Note: you can also use this in reverse to calculate angles from X and Y data.

5.5.4.3 Single Point Survey

This option enables you to enter all plane data from a single reference point directly under the intended flying point or above the stack position.

We recommend that you use a tripod to mount your laser distance measurement device and your inclinometer since the data entered is very sensitive to small errors.

Click Enter Using Laser + Inclinometer and a tool will appear that details the diagonal length and angle for each plane beginning and end.

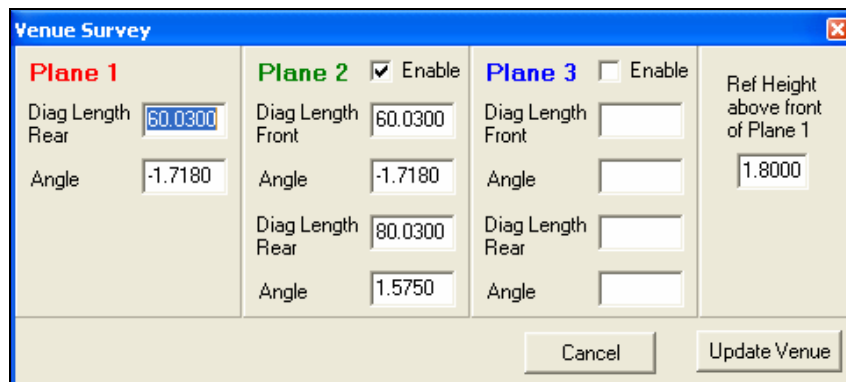

It also details the height of your distance measuring device above plane 1. If the stage is raised then include this height as well as the height of the device above the stage.

Note: It is assumed that plane 1 begins at the point where you mount the tripod and the array will be flown directly above it.

To enter data for each plane aim your device at the beginning and end of the plane and enter the values into the spaces provided. The units of measurement will be determined by the choice made in the main window and negative aiming angles imply the point aimed for is below the device.

Ensure that you have enabled or disabled the planes you require by checking the **enable** tick box for each plane.

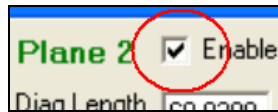

When you are satisfied with the data click **Update venue**, a conversion will then be made to the direct form of venue dimension.

You can switch back and forth between the single point survey and direct form at any time.

5.5.5 Coverage start and stop

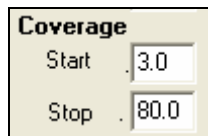

Specify the horizontal coverage distances from the front of the array. Coverage start and stop are shown as vertical grey bars on the view of the venue.

Please note:

A flown array's overall curvature will be significantly increased by very close coverage starts because the lower cabinets will need to aim further down. This will decrease the number of straighter cabinets towards the top of the array decreasing the efficiency of the far-field coverage.

See W8L Series Applications Guide [Section 5.4](#) to relate maximum source spl to loudspeaker quantity and curvature.

Always use a sensible choice of coverage start for the number of line array cabinets available, using front-fill loudspeakers for the first 5 or 6 rows if at all possible.

Front-fills will also improve imaging. See [Sect. 5.7.2](#)

5.5.6 Array Type

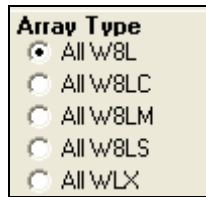

The choice of loudspeaker type depends on the application. See W8L Series Applications Guide [Section 5.4](#)

If a mixed system is selected a further section to the right allows you to define the quantity of the lower cabinets.

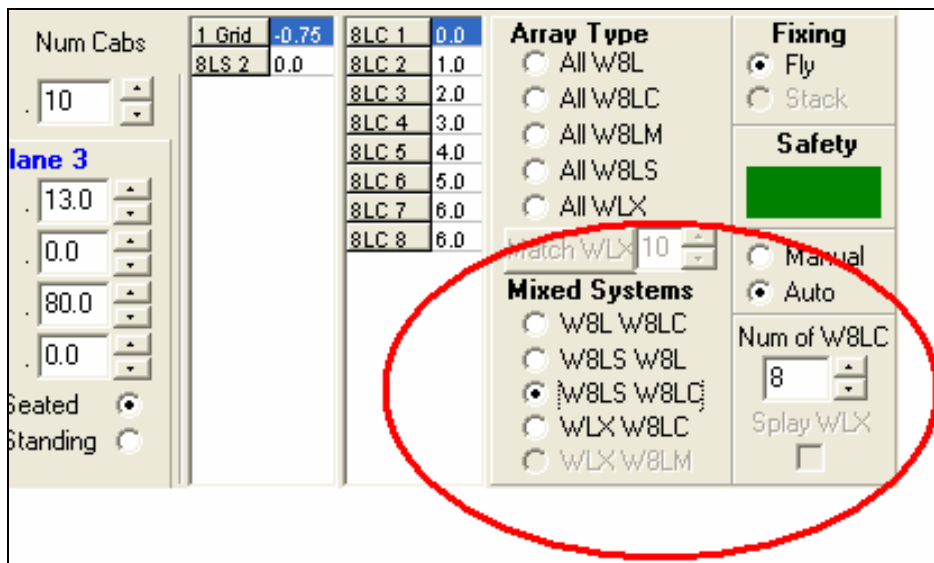

5.5.7 Array Fixing

Select either *Fly* or *Stack* in the *Fixing* section to determines how the array is supported.

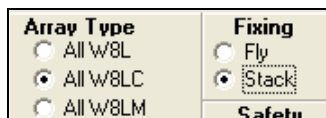

- ✚ In *Fly* mode the grid is suspended and cabinets are attached beneath
- ✚ In *Stack* mode the grid forms a base and cabinets are placed on top. Ground Stack Bars are fixed between the grid and the rear splay holes of the lowest cabinet to set the overall system tilt.

5.5.8 Designing a flown array

Minimum trim height

This is the low limit for the array and is defined as the smallest allowable distance from the lowest point of the array to the ground below.

You should set the minimum allowable trim height by sight line considerations. Work this out from venue information gathered from venue and stage set information. Make sure the array does not restrict the audience view from 1.8m above the highest audience plane to 2m above the highest upstage artist position.

Max Pick .	20.0
Min Trim .	3.0

Maximum pick height

Set this to the maximum array height allowable (usually the highest part of the flying frame).

The maximum pick height is usually chosen to allow for the maximum flying point height minus a sensible allowance for any shackles, stingers, bridles or flying hooks.

1m should be allowed for a stinger between each grid flying lug and the relevant motor hook to ensure that motor chain bags do not rest on the grid or top cabinet and upset its tilt angle.

Array Height

Set the array height for best coverage. It refers to the highest point of the array but does not include shackles, stingers, bridles or flying hooks.

Array height is an important aspect of line array system design.

A low flown system may interfere with sightlines and may be too straight to provide the smooth coverage that would be provided by a progressively curved array.

A high flown system may provide smooth coverage – but at the expense of maximum sound pressure level if the system curvature does not allow small enough inter-cabinet splay angles for efficient far-field projection. Again, see W&L Series Applications Guide [Section 5.4](#) to relate maximum source spl to loudspeaker quantity and curvature.

A system flown too high will be uncomfortable for the audience as the sound source will not coincide with the performance area.

Example

Venue view – inefficient design

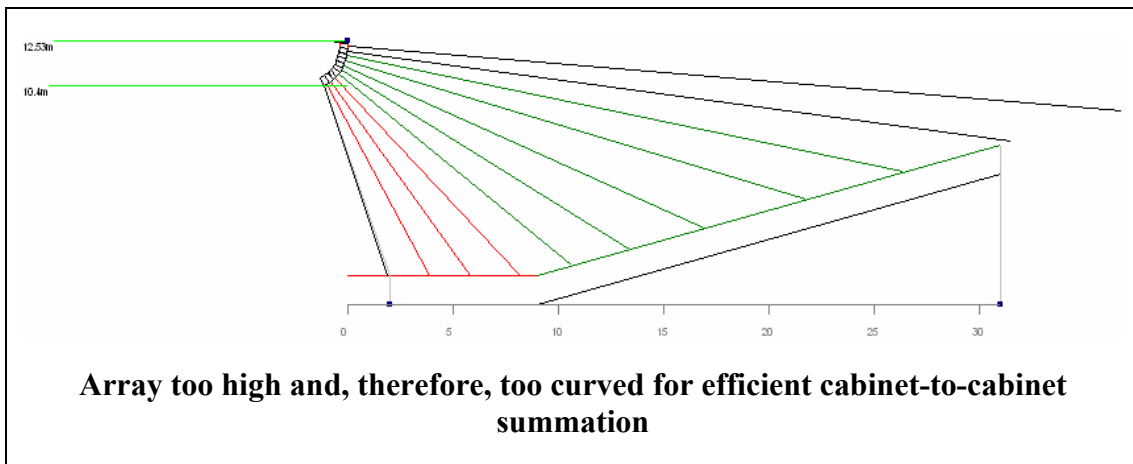

Array view – inefficient design

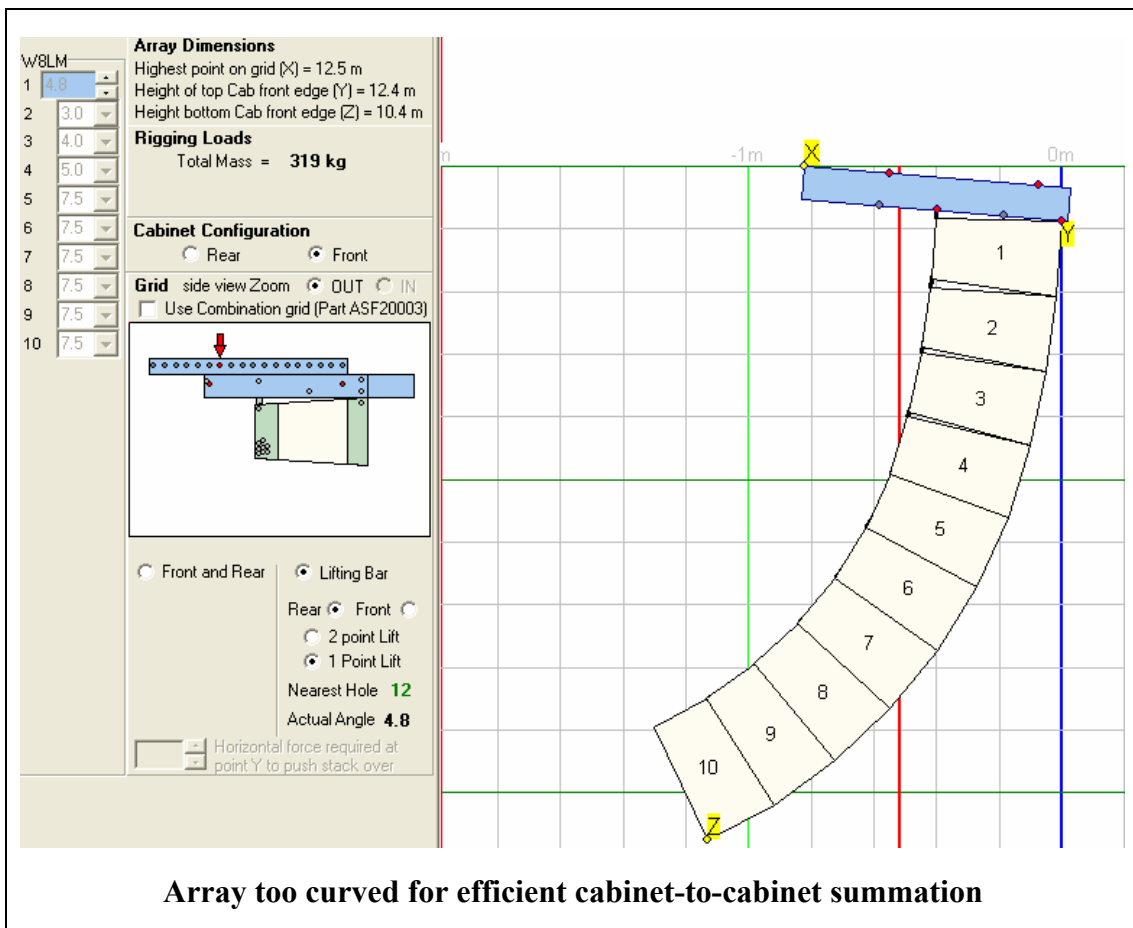

Venue view – efficient design

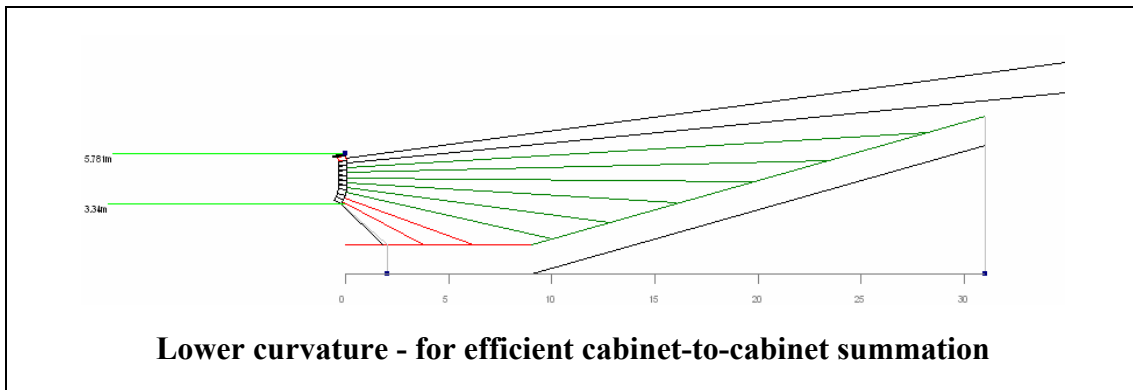

Array view – efficient design

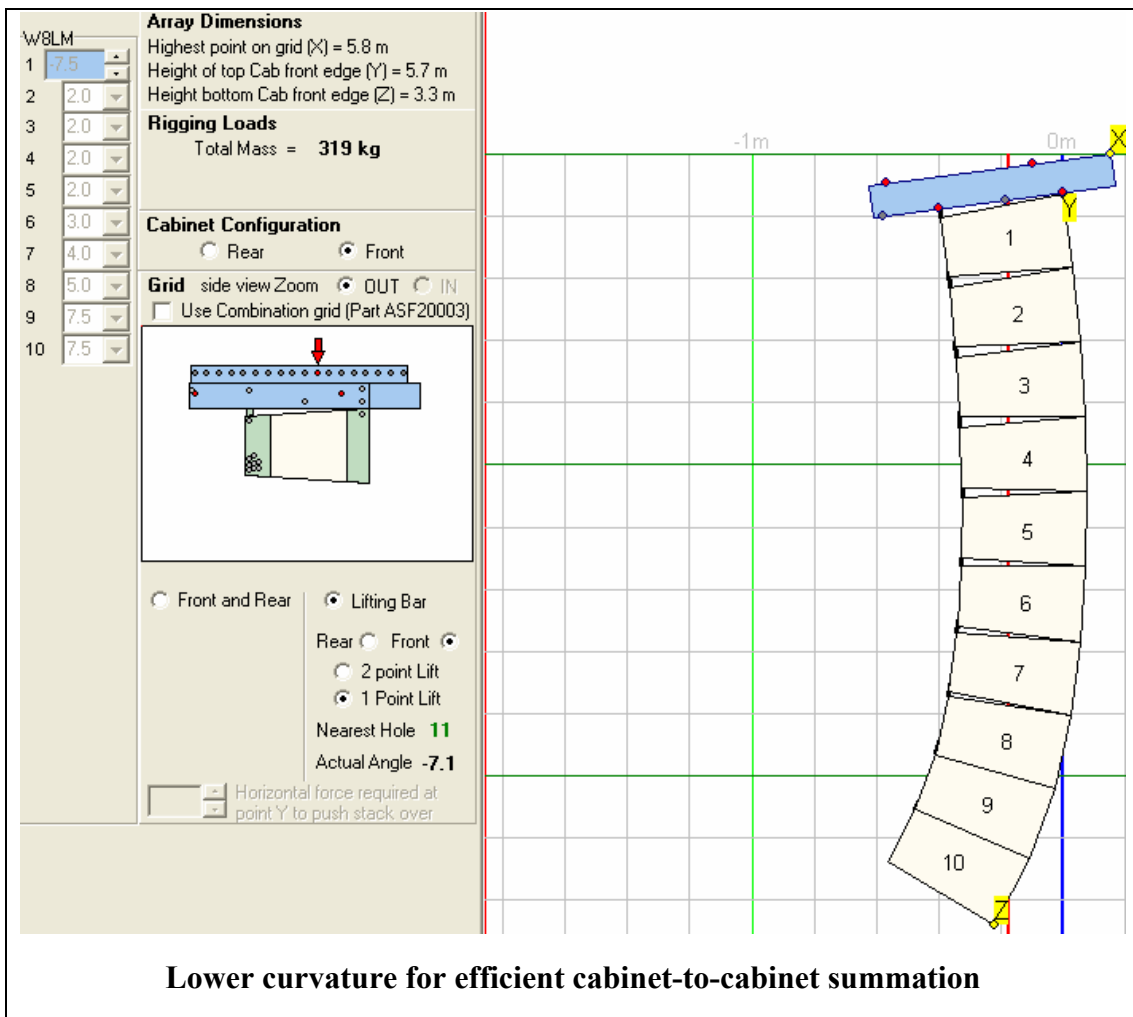

Number of cabinets

The default value is 10 cabinets and this is a good starting point for most situations.

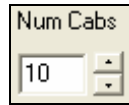

Click the **Design** button to see coverage, array length and splay angles.



You may wish to edit the number of cabinets to see how coverage, array length and splay angles are affected.

Note: the software will attempt to cover as wide an area as set by the coverage start and stop values. If the coverage (Start to Stop) cannot be met with the number of cabinets selected, a screen message will appear.

Coverage start not met

VERY IMPORTANT NOTE!!!

Long throw applications will require arrays long enough to ensure the appropriate vector summation for the distance to be covered. Too few cabinets may result in an inappropriate design. Once again, see W8L Series Applications Guide [Section 5.4](#).

Mixed systems

The number of cabinets in mixed systems relates to the total number of cabinets in the array. A separate control dictates how many of the lower cabinet types are present. See later.

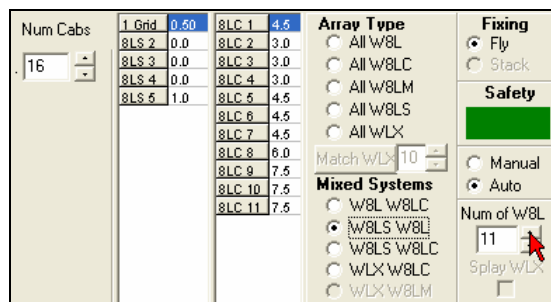

5.5.9 Stacked systems

When **Stack** is selected the maximum number of cabinets is limited and instead of **Array Height**, **Stage Height** appears in its place.

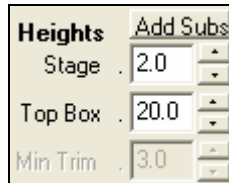

Set **Stage Height** to the vertical distance from the first plane to the floor of the stage. The **Add Subs** button allows the stack to be mounted on popular Martin Audio sub-woofers – with the sub-woofers either on the stage or stacked directly on the floor.

Note: If **Stage Height** is below the ear level of the first plane then the ear height becomes equal to the stage height.

5.5.10 Venue name

Enter the name of the venue. Previously saved venue names will appear here.



5.5.11 Editing ViewPoint™ designs

Once the initial venue and array parameters have been entered and the **Design** button has been clicked, venue and array data, can only be edited by clicking on the up or down symbols next to the appropriate data box.

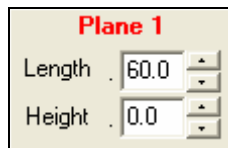

Whenever a value is altered the software will automatically recalculate splay angles.

5.5.12 Frequently asked questions

Q. Why is the top cabinet overshooting the furthest seat?

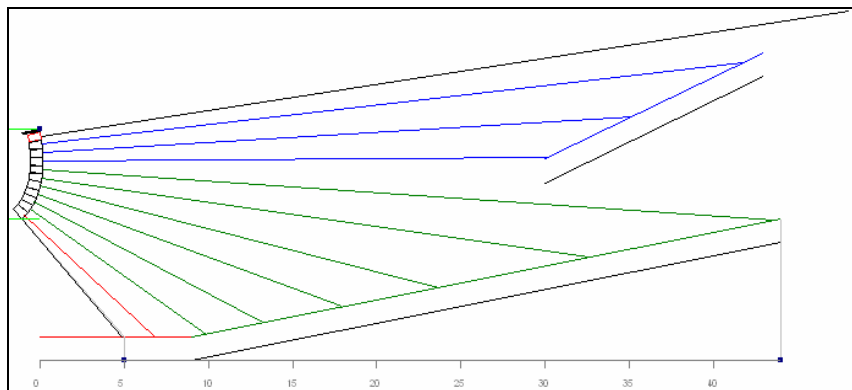

A. The auto calculation routine will tend to aim the top cabinet slightly beyond the coverage stop distance to give maximum vector summation at the furthest listening position. This is physics at work and is not a shortcoming of the W8 Series line arrays.

One benefit of this overshoot is that it can act as a hedge against coverage shortfalls caused by temperature and wind gradients bending the projected sound downwards. See W8L Series Applications Guide for further information about temperature and wind gradients.

Reducing reflections and overspill

ViewPoint™'s auto calculation routine is based on a combination of theoretical modeling* and practical experience and aims to give the most consistent frequency response over the audience surfaces as well as an even SPL distribution. We strongly recommend using ViewPoint™'s recommendations before attempting radically different schemes.

If there are highly reflective surfaces (or level sensitive neighbours) immediately beyond the **Coverage stop** point you may wish to reduce the level and overshoot at that point. This may be done by reducing the coverage stop distance until the top cabinet ray coincides with the highest/furthest audience area.

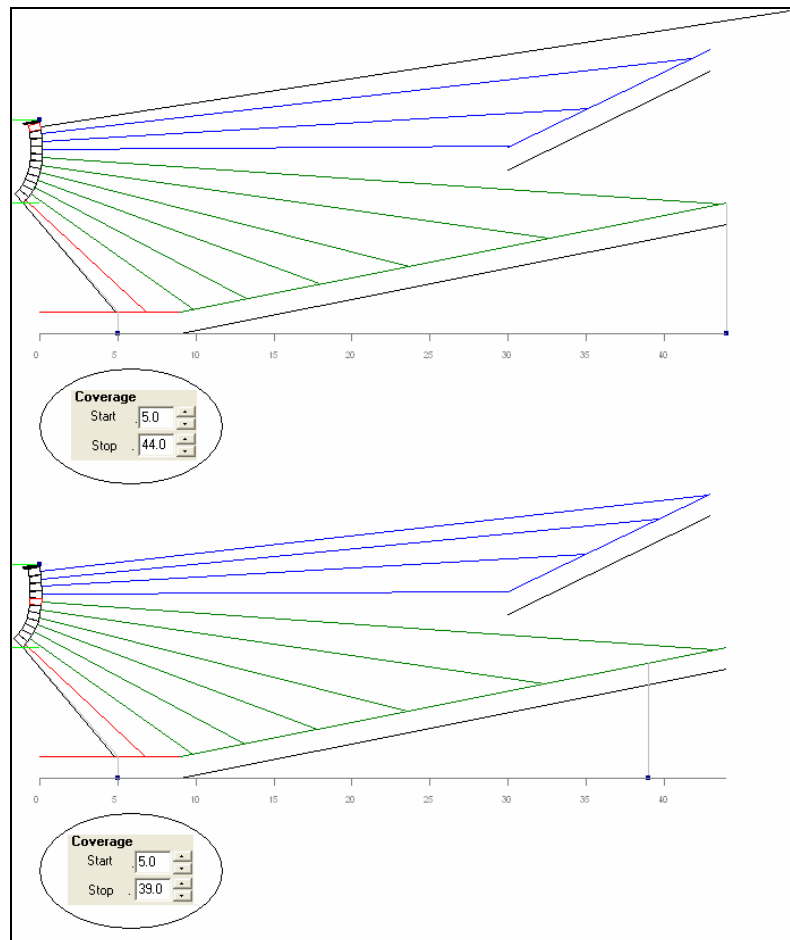

Q. The cabinet rays are spaced further apart in the 45 – 75m area. Surely this means that just one cabinet is covering more than fifteen meters of the audience?

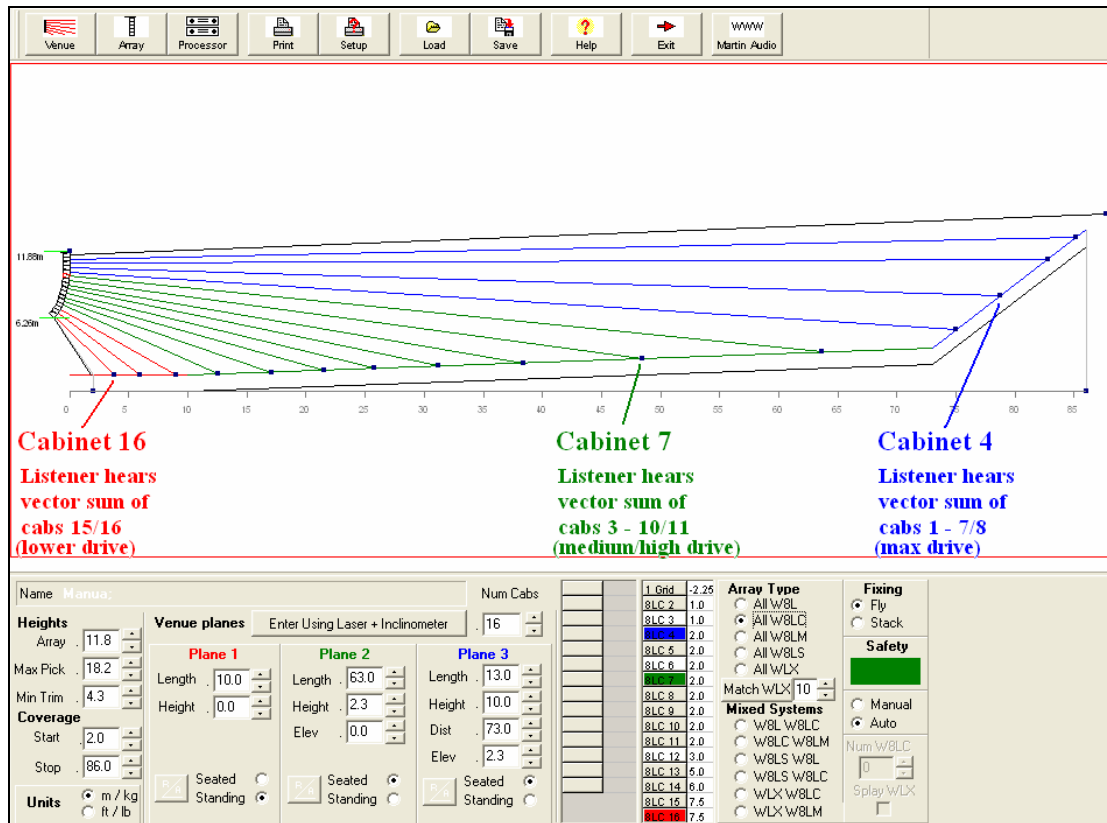

A. The rays shown on ViewPoint™ can be a little misleading because a series of rays arriving at a shallow angle will appear to be widely spaced.

Many users equate this with the sun’s rays which weaken as the sun sets. In fact, the setting sun’s power weakens due to greater absorption of shorter wavelengths through the earth’s curved atmosphere not because the rays are arriving at a shallow angle.

With W8L Series arrays, the sound pressure level at any point in the room can be thought of as the vector sum of all the cabinets +/-7.5 degrees from that point, not simply due to the cabinet whose ray is aiming there. The example above shows that the “cabinet 7” area receives contributions from cabinets 3 to 11, not just cabinet 7.

ViewPoint™’s Progressive Curvature calculations ensure that inter-cabinet splay angles increase gradually from the array and arrays are driven slightly harder towards the top of the array to partially compensate for air losses. This combination of Progressive Curvature and Band Zoning gives maximum projection to the furthest seats and the smoothest coverage.

5.5.13 Using ViewPoint™ for systems with sub-woofers

Flown W8LS sub-woofers

By default all W8LS splay angles are set to zero. If possible raise the array height so

that the W8LS cabinets are pointing downwards - or consider a parallel (side) W8LS or WLX sub-woofer array.

W8LS side arrays

Matching a W8LS side array to the curvature of a main W8L array is easy. Simply copy the W8L angles.

WLX side arrays

If you specify a WLX side array it should be designed to match the curvature of the main array. Matching adjacent WLX and W8LC array shapes is difficult (as they are different shapes and sizes) so ViewPoint™ does this for you:

Enter the number of WLXs you wish to use in the number box to the right of the **Match WLX** button, then click the **Match WLX** button.

A WLX array is generated that has a similar shape to your original main array.



Splaying WLX cabinets in mixed systems

In mixed WLX/W8LC systems ViewPoint™ may be used to aim the upper WLXs as close to the main audience area as the rigging system will allow whilst keeping the lower W8LC array pointing in the correct position for best coverage.

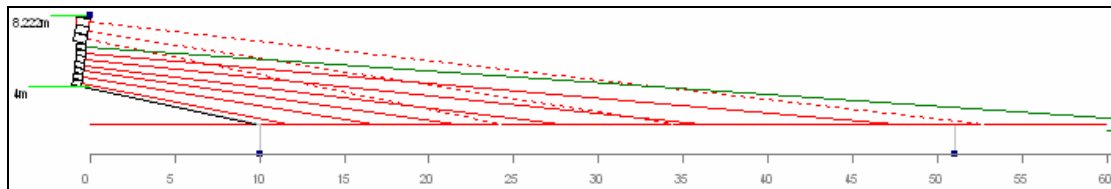

Click the **Splay WLX** control to enable/disable this feature.

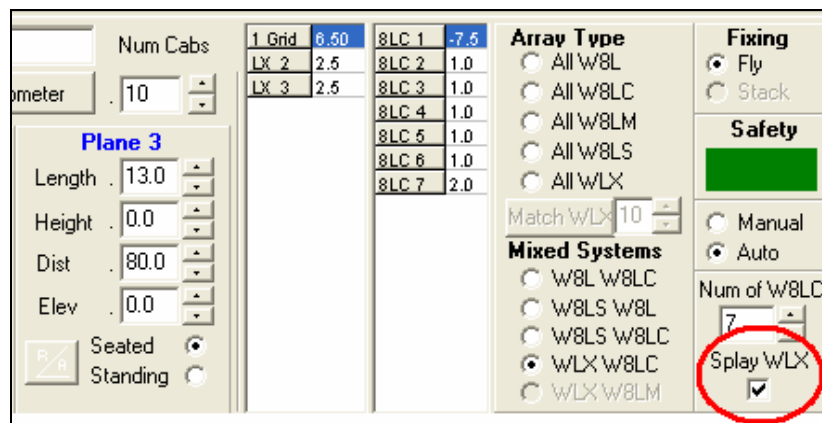

Sub-woofer placement and alignment? – see [Section 5.7](#)

5.5.14 Manual array editing (experts only!!!)

Should you wish to ignore ViewPoint™'s accurate coverage advice, continue with great caution, as follows:



Click on the **Manual** button (in Venue view) to manually edit splay angles and the array tilt angle.

- 1) Position the cross-hair over the dark blue squares at the end of each ray until the box turns red.
- 2) Use the left and right mouse buttons to increase or decrease the array tilt (top cabinet only) or inter-cabinet splay angles of the cabinets below.

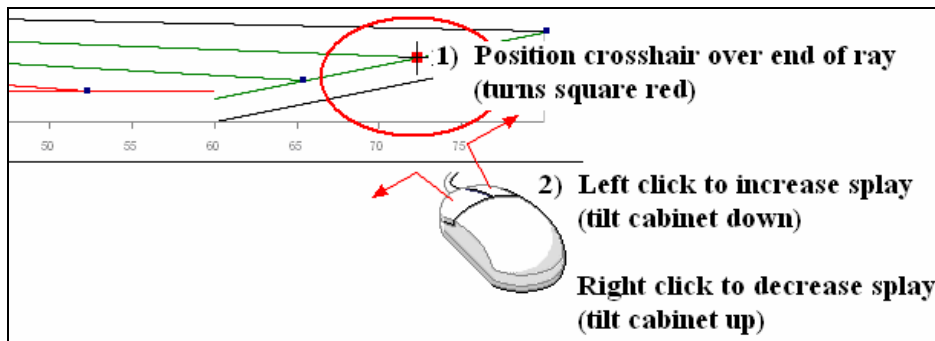

Alternatively . . .

- 1) Click on the splay angle to be altered to select a cabinet.

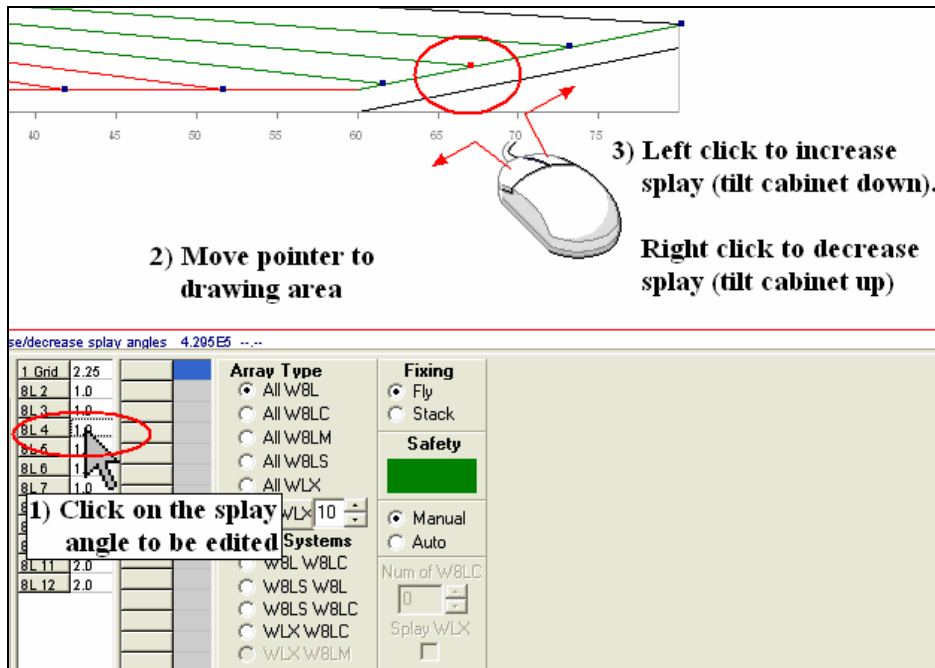

- 2) Move the mouse pointer into the top half of the screen.

3) Use the mouse buttons as described to change the angle. This is useful when the blue squares at the end of the uppermost rays lie outside the displayable area.

Note that the ray colours relate to Planes 1, 2 and 3. Occasionally, when a venue involves three planes or the second plane is a balcony which is above the level of the first plane, the auto calculation routine will indicate **black ray(s)** not pointing at the audience. This occurs when rays hit a vertical surface such as a balcony front.

Do not be tempted to switch off or heavily attenuate cabinets indicating a black ray as this could upset the line effect producing lobes and causing room colouration.

The user has the choice of ignoring the warning, which may be advisable if the balcony front is small or non-reflective, or manually editing the splay angles to miss the reflective surface.

It is not advisable to miss the surface completely as temperature gradients in the air can steer high frequencies upwards or downwards by 5° or more from the direction the cabinets are pointing in.

5.5.15 Array Page

Please note!

ViewPoint™'s Array page is for design/decision making only.

It does not guarantee safety. Safety will depend on the condition of the product, the suitability of supporting structures and personnel, weather conditions etc.

ViewPoint™ information should be passed to suitably qualified and experienced riggers for final decisions about loading, stability and safety.

5.5.15.1 Flown arrays

Click on the *Array* tab to show the rigging configuration and mechanical parameters.

This shows a close up of the array along with dimensions and splay angles. The gridlines are calibrated in 0.2m or 0.5ft increments, depending on which unit system is selected. Using the gridlines it is possible to read off dimensions such as the depth of any part of the array.

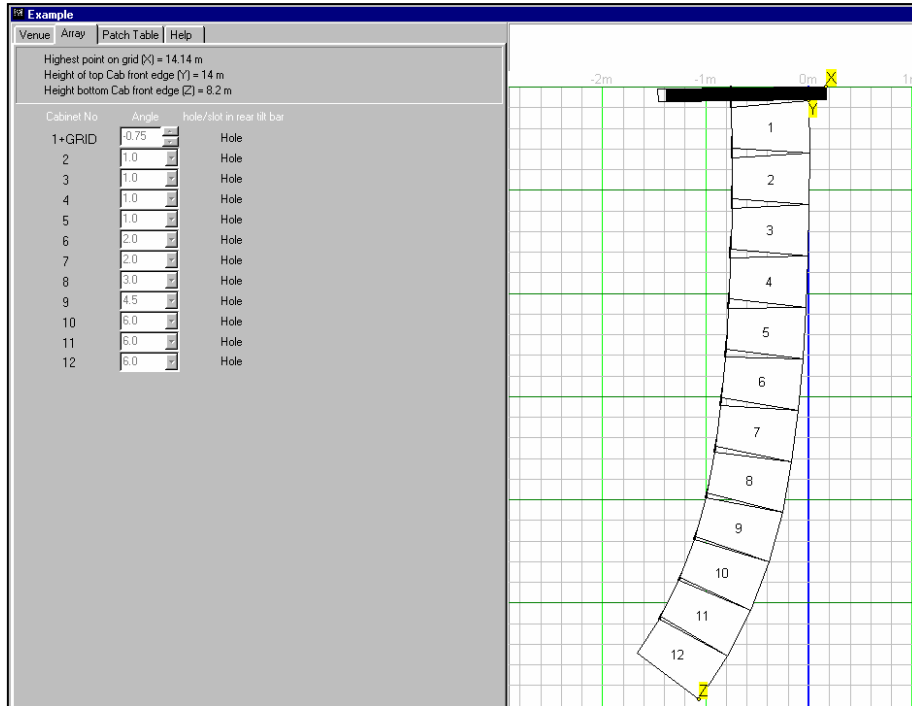

Note: the top corner of the top cabinet is always positioned above the reference point on the venue view. This is shown by the blue vertical line on the **Array** view which indicates the datum point from which coverage Start/Stop distances are measured.

Pick Points and Cabinet Positions

Two grid pick points (front & rear) are shown for flown arrays.

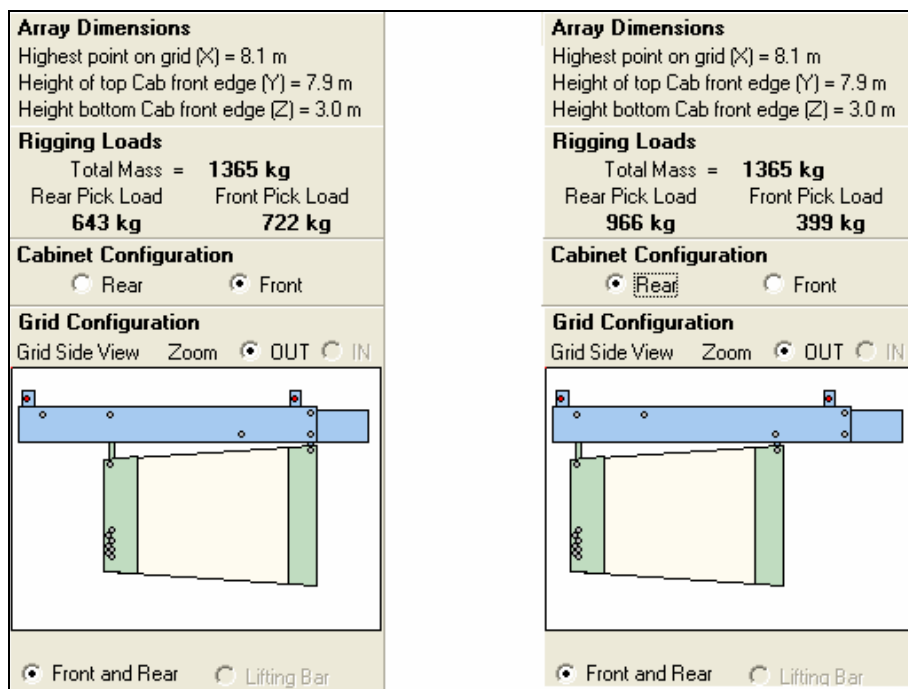

The cabinet grid position can be selected as either Front or Rear depending on the amount of system tilt required. The rear positions makes more down-tilt (+ve angle) available and the front position makes more up-tilt (-ve angle) available.

Lifting Bar Option

A **Lifting Bar** option is available for W8LC, WLX and W8LM flown arrays.

When **Lifting Bar** is selected further options become available.

The lifting bar can be placed in the **Rear** or **Front** position and can be lifted at either one or two points.

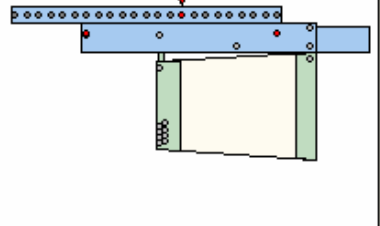
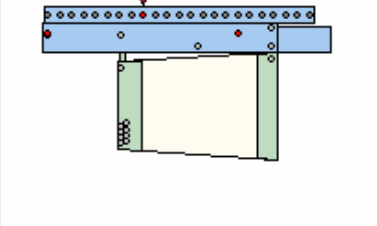
<p>Array Dimensions Highest point on grid (X) = 8.0 m Height of top Cab front edge (Y) = 7.9 m Height bottom Cab front edge (Z) = 4.4 m</p> <p>Rigging Loads Total Mass = 637 kg</p> <p>Cabinet Configuration <input type="radio"/> Rear <input checked="" type="radio"/> Front</p> <p>Grid Configuration Grid Side View Zoom <input checked="" type="radio"/> OUT <input type="radio"/> IN</p>  <p><input type="radio"/> Front and Rear <input checked="" type="radio"/> Lifting Bar Rear <input checked="" type="radio"/> Front <input type="radio"/> <input type="radio"/> 2 point Lift <input checked="" type="radio"/> 1 Point Lift Nearest Hole 9 Actual Angle -0.14</p>	<p>Array Dimensions Highest point on grid (X) = 8.0 m Height of top Cab front edge (Y) = 7.9 m Height bottom Cab front edge (Z) = 4.4 m</p> <p>Rigging Loads Total Mass = 637 kg</p> <p>Cabinet Configuration <input type="radio"/> Rear <input checked="" type="radio"/> Front</p> <p>Grid Configuration Grid Side View Zoom <input checked="" type="radio"/> OUT <input type="radio"/> IN</p>  <p><input type="radio"/> Front and Rear <input checked="" type="radio"/> Lifting Bar Rear <input type="radio"/> Front <input checked="" type="radio"/> <input type="radio"/> 2 point Lift <input checked="" type="radio"/> 1 Point Lift Nearest Hole 9 Actual Angle 0.022</p>
---	--

Single Point Lift

This displays the **Nearest hole** in the lifting bar and the **Actual Angle** of the grid when lifted at that hole.

Note that ViewPointtm will display a warning if there is no suitable hole available.

C.O.G is not coincident with any Hole

Adjusting the array height slightly on the *Venue* page will often position the system on a suitable hole or narrow the gap between the required angle and the angle given by the nearest hole. Flip between *Venue* and *Array* pages to set and recheck.

(If the required lifting point is too far back, make sure that the lifting bar is in the rear position and that the cabinet is mounted at the front of the grid before trying an alternative height. Similarly, if the required lifting point is too far forward, make sure that the lifting bar is in the front position and the cabinet is mounted at the rear of the grid before trying an alternative height)

Splay Angles

W8LC	Angle
1	-2.8
2	1.0
3	1.0
4	2.0
5	2.0
6	2.0
7	2.0
8	2.0
9	2.0
10	2.0
11	2.0
12	3.0
13	4.0
14	5.0
15	6.0
16	7.5

Required angle
 (+ve = down-tilt
 -ve = up-tilt)

Rigging Loads
 Total Mass = 985 kg

Cabinet Configuration
 Rear Front

Grid side view Zoom OUT IN
 Use Combination grid (Part ASF20003)

Front and Rear Lifting Bar
 Rear Front
 2 point Lift
 1 Point Lift
 Nearest Hole 7
 Actual Angle -2.8

Two Point Lift

This places a pick point at each end of the bar.

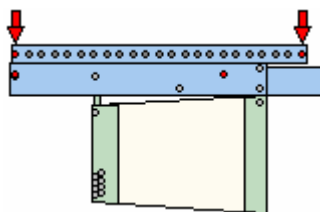

A two-motor lift from a lifting bar will...

- ✚ Enable more extreme up-tilts and down-tilts because the lifting bar extends beyond the front lifting point forward of the normal grid tab in the front position and extends the rear lifting point behind the normal grid tab in the rear position
- ✚ Spread the array load across two rigging points
- ✚ Allow fine angular control using the motors

Load Indicators

Depending on the grid configuration the 'Rear Pick Load' and 'Front Pick Load' are displayed as well as total mass. These loads as well as the forces between cabinets are checked after each change of the array or grid.

Rigging Loads	
Total Mass =	1365 kg
Rear Pick Load	Front Pick Load
643 kg	722 kg

Should either of the pick loads become less than zero or the inter-cabinet forces become too high then a mechanical warning window will appear.

Mechanical Safety Warning		
Position	Load	Safety factor
Cabinet Front links	-516.73 kg	16.52
Cabinet Rear links	1507.30 kg	7.92
Grid Front Pick point	-114.63 kg	250.81
Grid Rear Pick point	1860.60 kg	15.45
COG Position	NOT between pick points	

Help >>

5.5.15.2 Stacked arrays

Splay Angles

WBLM

1 1.0

2 1.0

3 2.0

4 4.0

5 5.0

6 10.0

Array Dimensions

Height of top Cab front edge (Y) = 3.6 m

Rigging Loads

Total Mass = **174 kg**

Rear Pick Load Front Pick Load

Cabinet Configuration

Rear Front

Grid Configuration

Grid Side View Zoom OUT IN

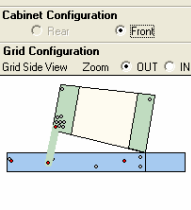

Front and Rear Lifting Bar

Rear Front

2 point Lift

1 Point Lift

Nearest Hole

Actual Angle

200 Horizontal force required at point Y to push stack over

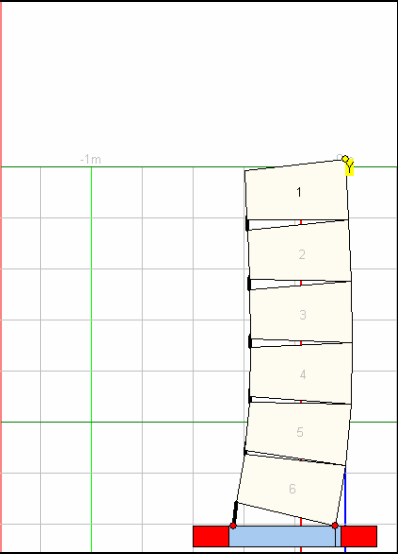

When designing ground-stacked arrays, inspect the array view and check that the center of gravity is in a safe place.

Stack stability

Red stability limits are indicated within the grid on the *Array* page – circled on the right below.

If the centre of gravity crosses this red region the force required to push or pull the array over is less than that shown in the box beside the array view and a mechanical warning is raised.

Please note: This assumes that no sliding takes place. Grids should be securely attached to the ground in all cases.

The push value (in Newtons) – shown circled on the left below - can be varied to simulate wind load.

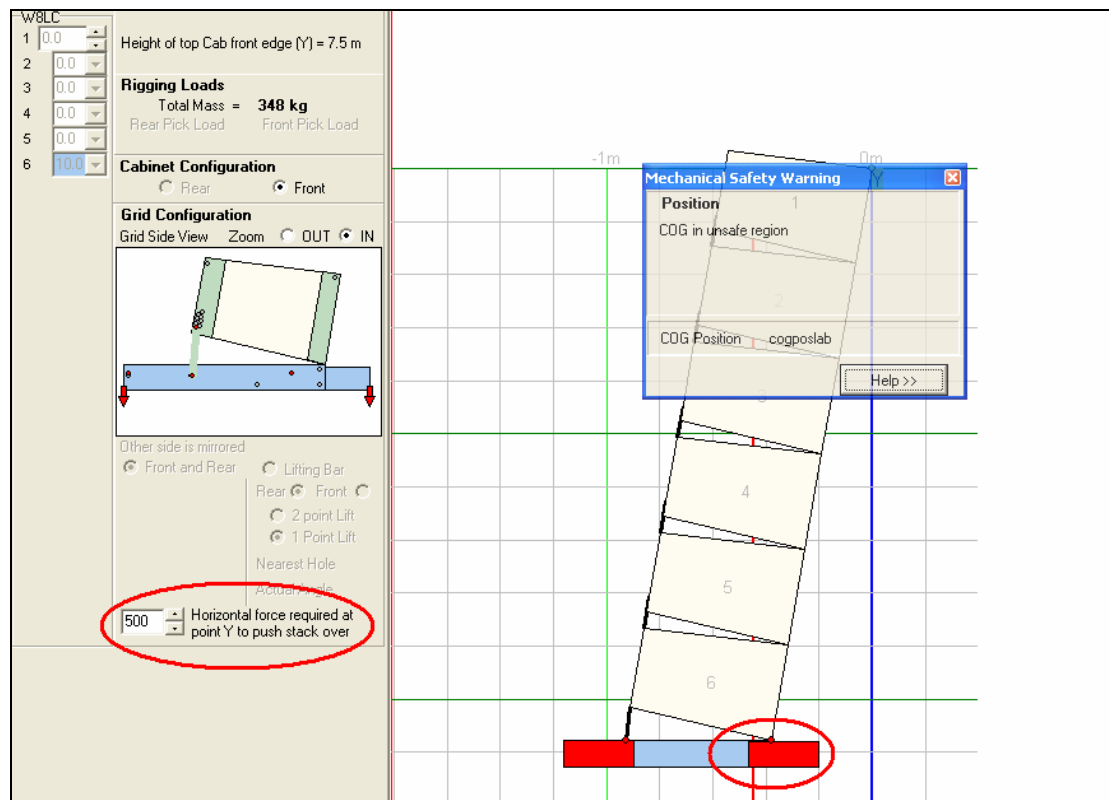

Zoom In

This shows the ground-stack bar position required for the lowest cabinet angle.

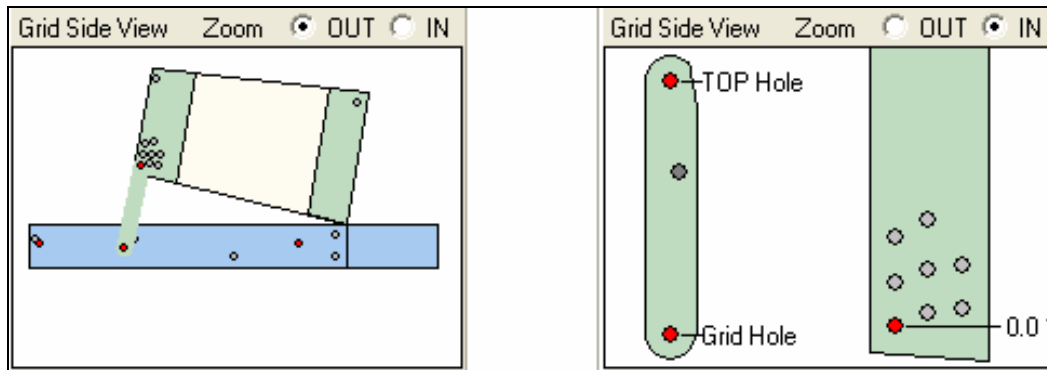

5.5.16 Processor page

The *Processor* page shows a controller-to-amplifier patch table and indicates which controller settings to use for the design.

The page also shows power amplifier rack layouts to ensure that the amplifiers share the power demand adequately (see Quick Start sections for advice on rack layouts and mains distribution). Move your mouse cursor over the greyed out amplifier racks to see further rack details.

Martin Audio ViewPoint 3.01

Controller Settings

16w8L HF CUT
16w8L HF NORMAL
16w8L HF BOOST

TILT AND DISPLAY ANGLES		SPEAKER		CONTROLLER O/P CHAN		
CAB	ANGLE	TYPE	O/P GROUP	LF	MF	HF
1+Grid	3.00 H°	W8L	H	1	3	6
2	1.0 H°	W8L	H	1	3	6
3	1.0 H°	W8L	G	1	3	6
4	1.0 H°	W8L	G	1	3	6
5	1.0 H°	W8L	F	1	3	6
6	1.0 H°	W8L	F	1	3	6
7	1.0 H°	W8L	E	1	3	6
8	1.0 H°	W8L	E	1	3	6
9	1.0 H°	W8L	D	1	3	6
10	1.0 H°	W8L	D	1	3	6
11	1.0 H°	W8L	C	1	3	5
12	1.0 H°	W8L	C	1	3	5
13	1.0 H°	W8L	B	1	2	5
14	2.0 H°	W8L	B	1	2	5
15	2.0 H°	W8L	A	1	2	4
16	2.0 H°	W8L	A	1	2	4

Amplifier patch diagram (rear of MA4.2 amp shown)

Historically, array cabinets have been numbered from top to bottom (see Quick Start sections). W8L and W8LC line array section impedances are all 8 ohms and usually driven in pairs so that each power amplifier channel sees a 4 ohm load. W8LM line array section impedances are about 13 ohms and are usually driven in fours to present a 3.25 ohm load.

In practice, multipurpose racks are more easily configured for a wide variety of array sizes by driving the arrays in the opposite direction - from the bottom up. Smaller line array configurations can be driven from large multipurpose racks by leaving the upper, more equalized, outlets unused. This is indicated on the **Processor** page by lettering the amplifier channel/loudspeaker outlets A-H with A at the bottom.

The following example relates 16-speaker rack outlets to the top-to-bottom cabinet numbering. Note that W8Ls and W8LCs are driven in pairs whereas W8LMs are driven in fours.

Speaker Outlet	Cabinet number	
	W8L/W8LC (pairs)	W8LM (fours)
H	1 & 2	
G	3 & 4	
F	5 & 6	
E	7 & 8	
D	9 & 10	1 – 4
C	11 & 12	5 – 8
B	13 & 14	9 – 12
A	15 & 16	13 – 16

Controller presets



The recommended DX1 or DP226 controller preset is shown on the Processor page. Most of our line array controller presets include extra channels for Band Zoning. Band Zoning is a technique of splitting the array into various MF and HF zones to provide more air absorption compensation for the upper (longer throw) sections.

Controller Settings						
- Reduced HF EQ						
12W8L HFCUT						
- Standard HF EQ						
12W8L HFNORMAL						
- Increased HF EQ						
12W8L HFBOOST						
TILT AND DISPLAY ANGLES			SPEAKER	CONTROLLER O/P CHAN		
CAB	ANGLE	TYPE	O/P GROUP	LF	MF	HF
1+Grid	0.75 H°	W8L	F	1	3	6
2	1.0 H°	W8L	F	1	3	6
3	1.0 H°	W8L	E	1	3	6
4	1.0 H°	W8L	E	1	3	6
5	1.0 H°	W8L	D	1	3	6
6	1.0 H°	W8L	D	1	3	6
7	1.0 H°	W8L	C	1	3	5
8	1.0 H°	W8L	C	1	3	5
9	1.0 H°	W8L	B	1	2	5
10	2.0 H°	W8L	B	1	2	5
11	2.0 H°	W8L	A	1	2	4
12	2.0 H°	W8L	A	1	2	4

*(H)ole or (S)lot in rear tilt bar



A typical large scale system will have its LF sections driven in unison, its MF split into upper (far-field) and lower (near-field) zones and its HF split into upper (far-field), middle (mid-field) and lower (near-field) zones. See [Section 5.9](#) for more on Band Zoning and Sections [5.10 \(W8L\)](#), [5.11 \(W8LC\)](#) or [5.12 \(W8LM\)](#) for rack info.

Note that W8L and W8LC presets also offer a choice of settings –

 **HFCUT**
 **HFNORMAL**
 **HFBOOST**

These are intended to cater for differing propagation conditions and, of course, personal taste.

We recommend the following settings for differing humidity conditions:

 **HF BOOST** when RH = 10 to 30%
 **HF NORMAL** when RH = 30 to 50%
 **HF CUT** when RH = 50 to 100%.

W8L presets have an **HF VARIABLE** setting to allow the user to manually adjust HF equalisation for atmospheric effects and personal taste.

A reminder ...

ViewPoint™ produces sonically accurate results based on high resolution loudspeaker data and the audience coverage. You must use the exact reference preset and amplifier patch for accurate Band Zoning and smooth coverage.

- 1) The controller preset names shown on ViewPoint™ correspond to the preset names on our published Martin Audio DX1, XTA DP226 or XTA AudioCore data files.**
- 2) Please ensure that controllers are loaded with our standard reference presets for the W8L Series loudspeaker in use.**
- 3) Users should start with a unity gain, zero delay, flat frequency response controller input section and revert back to our standard presets at the beginning of each venue setup to avoid using settings contaminated with room equalization from a previous gig.**

5.5.17 Saving a venue or array design to disk

Select the *Venue* page and click on *Save*.

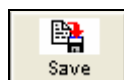

CONTINUED..

Appendix 1

Wavefront W8 3-Way System

Contents

<u>A1.1</u>	Introduction
<u>A1.2</u>	Specifications
<u>A1.3</u>	Pin-outs and cabling
<u>A1.4</u>	System patching
<u>A1.5</u>	DX1 Loudspeaker Management System
<u>A1.6</u>	Power amplifier recommendations
<u>A1.6.1</u>	Martin Audio MA2.8 Power Amplifier Overview
<u>A1.7</u>	General operational summary
<u>A1.8</u>	Arraying and placement
<u>A1.9</u>	Coverage calculations
<u>A1.10</u>	W8 front fills
<u>A1.11</u>	W8 side clusters
<u>A1.12</u>	W8 distributed (delay) systems
<u>A1.13</u>	Combining W8s with other Wavefront systems

Wavefront W8 3-Way System



A1.1 Introduction

The Wavefront W8 3-Way System is a high performance 3-way loudspeaker system in a trapezoidal cabinet. The Wavefront W8 integrates two horn-loaded 12" low-mid drivers with a horn-loaded 6.5" high-mid driver and a horn-loaded 1" very high frequency compression driver. The 6.5" high-mid cone driver provides a better order of performance than a large compression driver and is optimally loaded using a toroidal phase plug.

Wavefront series trapezoidal cabinets are fitted with MAN load-certified flying points and are designed to comply with the 12:1 safety factor specified by the German VBG70 standard when used with compatible 12:1 flying systems. One important advantage of the MAN flying system is that inter-cabinet connections place a minimal load on the cabinets and, being external, can be load certified and inspected independently.

A1.2 Specifications

Type:	3-way trapezoid, switchable active/passive high-mid/high via rear panel switch (see Section A1.5)
Frequency response:	120Hz - 18kHz +/- 3dB
LF limit:	-10dB @ 80Hz
Drivers:	2 x 12" (305mm) low-mid horn 1 x 6.5" (165mm) high-mid horn 1 x 1" (25mm) exit hf compression driver

Rated power:	Low-mid 400W AES, 1600Wpk High-mid (active/passive) 150WAES, 600Wpk High (active) 60W AES, 240Wpk
Sensitivity:	Low-mid 106dB/W High-mid 108dB/W High 107dB/W
Maximum SPL:	129dB continuous, 135dB peak
Impedance:	Low-mid 8 ohms nominal High-mid 16 ohms nominal High 16 ohms nominal
Coverage (-6dB):	55° horizontal, 30° vertical
Crossover:	750Hz, 3.5kHz
Connectors:	2 x Neutrik NL8, 2 x EP8
Cabinet construction:	Birch Ply
Cabinet finish:	Slate textured paint
Protective grille:	Perforated steel
Grille finish:	Grey paint
Dimensions (incl wheels):	(W) 562mm x (H) 1066mm x (D) 925mm (W) 22.1ins x (H) 42.0ins x (D) 36.5ins
Weight:	90kg (198lbs)

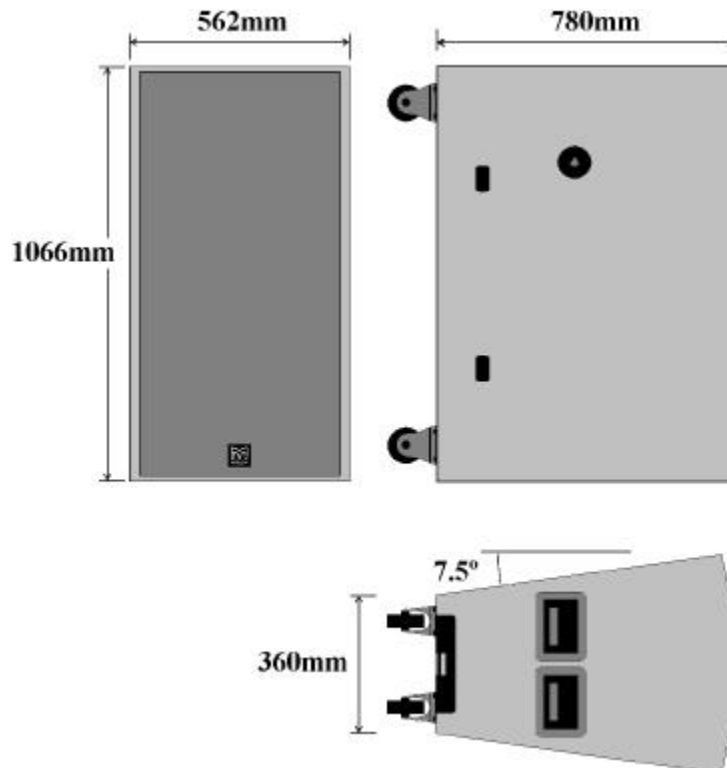

A1.3 Pin-outs and cabling

W8

Connector type

W8 mode

EP8	NL8	W8 Active*	W8 Passive*
1	-1	Low Mid -	Low Mid -
2	+1	Low Mid +	Low Mid +
3	-2	High Mid -	High Mid/High -
4	+2	High Mid +	High Mid/High +
5	-3	High -	n/c
6	+3	High +	n/c
7	-4	n/c	n/c
8	+4	n/c	n/c

(*see [Section A1.5](#) for details of the connector panel Active/Passive switch)

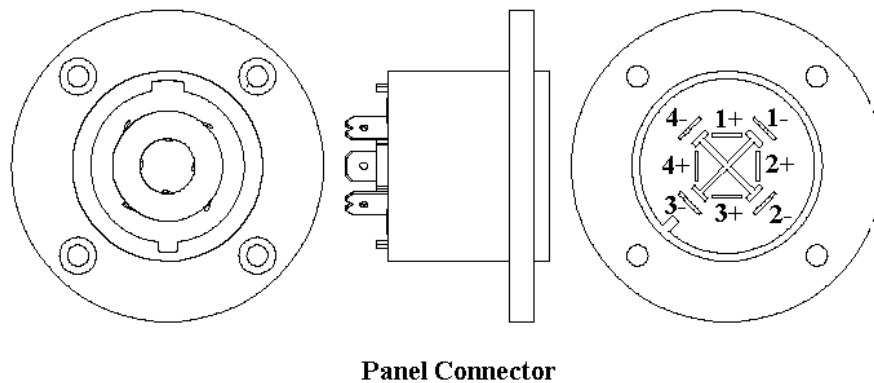
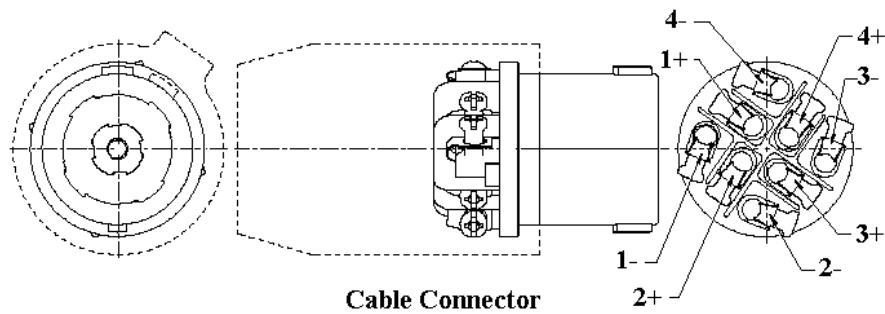

A1.3.1 Cable and panel connector part numbers

Please note the following part numbers when ordering loudspeaker connectors to make up cables and patch panels

Neutrik NL connectors

NL8FC	8 pole cable (female)
NL8MPR	8 pole panel (male)
NL8MM	8 pole inline coupler (male-male)

Cannon EP connectors

EP8-11	8 pin cable female
EP8-12	8 pin cable male
EP8-13	8 pin panel mount female
EP8-14	8 pin panel mount male

Connectors should be kept in good, clean, uncorroded condition to ensure full, undistorted loudspeaker performance. Corroded or damaged pins and sockets can cause severe distortion or loss of signal.

A1.3.2 Recommended loudspeaker cable

Cable run vs copper core cross sectional area



	Single W8	Two W8 paralleled at the cluster.
Up to 50m	2.5mm ²	6mm ² (or 2 x 2.5mm ² cores in parallel)
Up to 100m	6mm ²	10mm ² (or 2 x 6mm ² cores in parallel)

Q. Why the odd sizes?

A. Loudspeaker cables are available in a limited range of standard copper core sizes - ie. 1.5mm², 2.5mm², 4mm², 6mm², 10mm² and 35mm².

A1.4 System patching

A good system patch should...

- 1) Be electrically safe - ie be put together by suitably qualified electrical technicians paying attention to possible sources of moisture, connector damage, cable damage, user and public safety.
- 2) Enable the system to provide the required sound quality, coverage and level without feedback and without stressing its mechanical, electrical or

electro-acoustic components.

- 3) Be divided into easily understood sections (eg Main, midfield, downfill etc) and clearly labelled so that adjustments may be made quickly and efficiently.

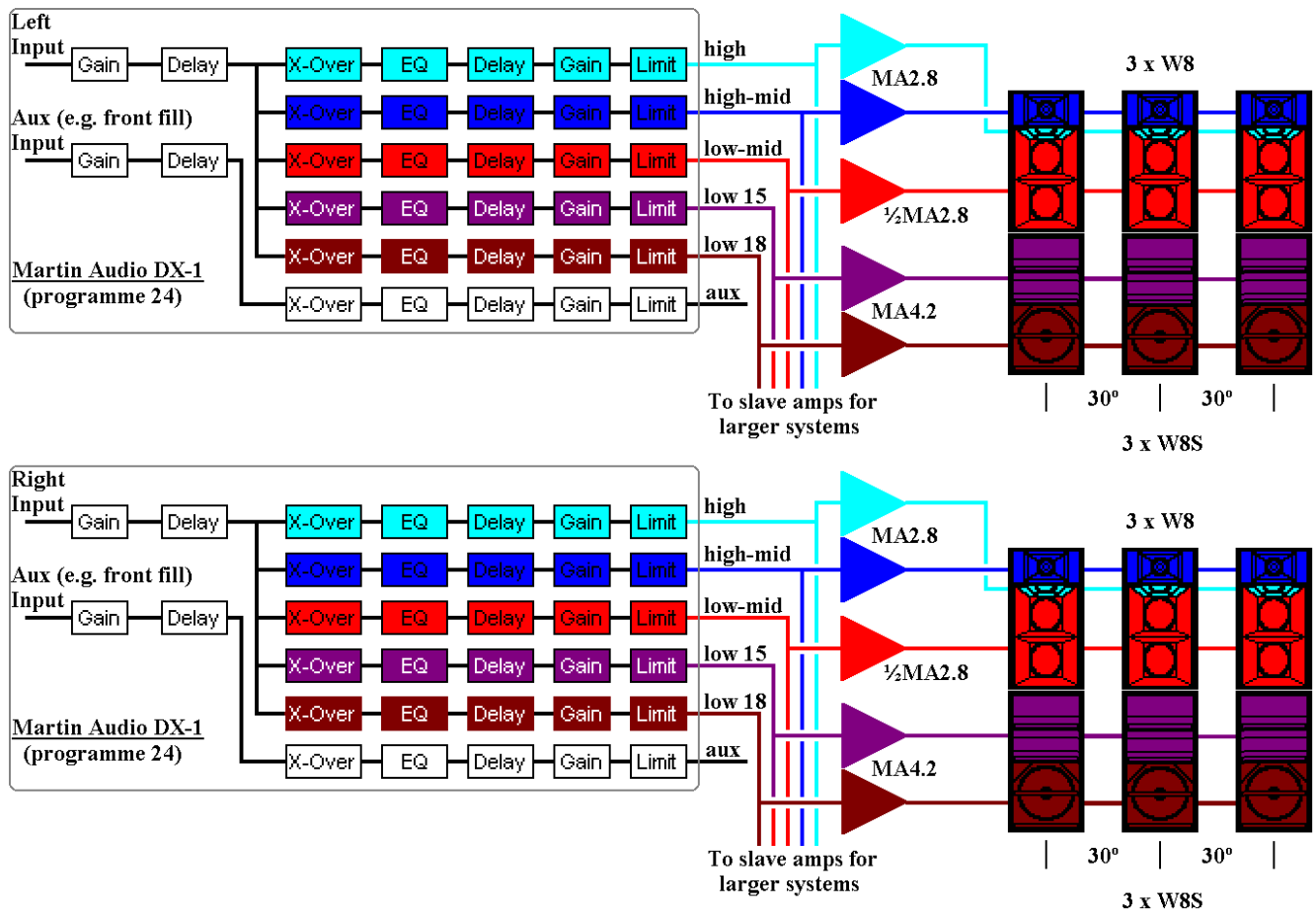

The schematic above shows a simple stereo PA set-up using two Martin Audio DX1 Loudspeaker Management Systems configured as 5-way crossovers controlling 3 x W8 per side switched for fully active (3-way) operation augmented with W8S subwoofers.

Larger systems may be assembled using the same two DX1 units - but with extra "slave" amplifiers and loudspeakers.

See [Section A1.5](#) for further DX1 information.

A1.4.1 Cluster sub-sections

When designing a large sound system it is worth spending a little time working out a sensible cluster patch to optimise audience coverage.

The following example is a 4 wide, 4 deep W8 classical music centre cluster divided into farfield, midfield, nearfield and downfill horizontal rows and inner and outer vertical columns. The active W8s may be patched in pairs for symmetrical control.

2ch power amplifier allocations:

Farfield inner & outer high
 Midfield inner & outer high
 Nearfield inner & outer high
 Downfill inner & outer high

Farfield inner & outer himid
 Midfield inner & outer himid
 Nearfield inner & outer himid
 Downfill inner & outer himid

Farfield inner & outer lomid
 Midfield inner & outer lomid
 Nearfield inner & outer lomid
 Downfill inner & outer lomid

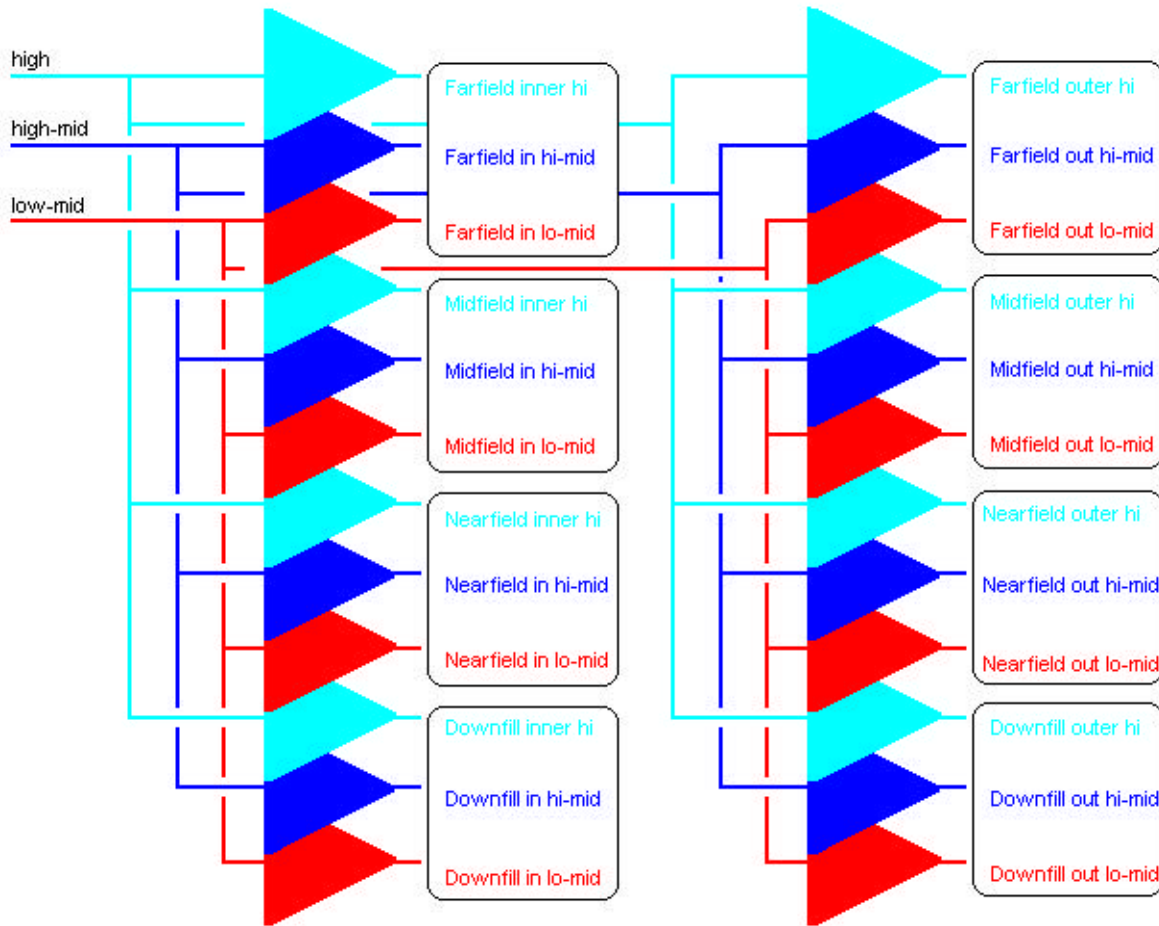

Initial inner level settings

Initial inner level settings can be calculated for each row as follows:

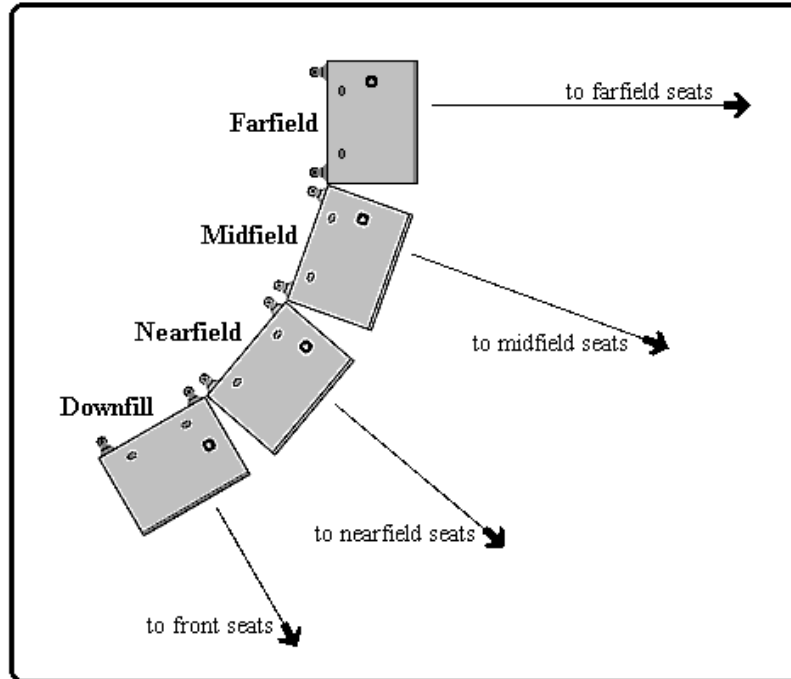

The farfield inner power amplifier channels are the reference...

Assuming that the farfield inner amp channels = 0dB (fully cw),
Inner amplifier gain control setting calculations are:

$$\text{Midfield inner amp channels} = 20 \times \log_{10} \frac{\text{midfield inner distance}}{\text{farfield inner distance}}$$

$$\text{Nearfield inner amp channels} = 20 \times \log_{10} \frac{\text{nearfield inner distance}}{\text{farfield inner distance}}$$

$$\text{Downfill inner amp channels} = 20 \times \log_{10} \frac{\text{downfill inner distance}}{\text{farfield inner distance}}$$

Initial outer level settings

Similarly, initial outer level settings can be calculated for each row as follows:

Again, the farfield inner amplifier setting (0dB) is used as a reference...

Assuming that the farfield inner amp channels = 0dB (fully cw),
Outer amplifier gain control setting calculations are:

Farfield outer amp channels	=	$20 \times \log_{10} \frac{\text{farfield outer distance}}{\text{farfield inner distance}}$
Midfield outer amp channels	=	$20 \times \log_{10} \frac{\text{midfield outer distance}}{\text{farfield inner distance}}$
Nearfield outer amp channels	=	$20 \times \log_{10} \frac{\text{nearfield outer distance}}{\text{farfield inner distance}}$
Downfill outer amp channels	=	$20 \times \log_{10} \frac{\text{downfill outer distance}}{\text{farfield inner distance}}$

In a fairly small, wide, fan-shaped venue with heavily raked seating, we may require the following amplifier channel settings:

Farfield Inner	0dB (fully cw)
Farfield Outer	0dB (fully cw)
Midfield Inner	-2dB
Midfield Outer	-2dB
Nearfield Inner	-4dB
Nearfield Outer	-4dB
Downfill Inner	-6dB (front row centre)
Downfill Outer	-5dB (front row outers)

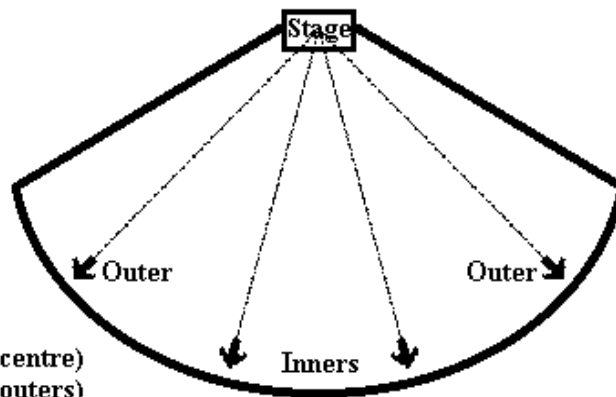

The attenuation rate shown here is 2dB per cluster row. The actual rate of vertical attenuation will depend on the cluster height which in turn will depend on the rake of the seats. High clusters are further from the audience at the front and require less nearfield & downfill attenuation. The lower the cluster, the greater the required attenuation rate.

Again, the vertical layout is...

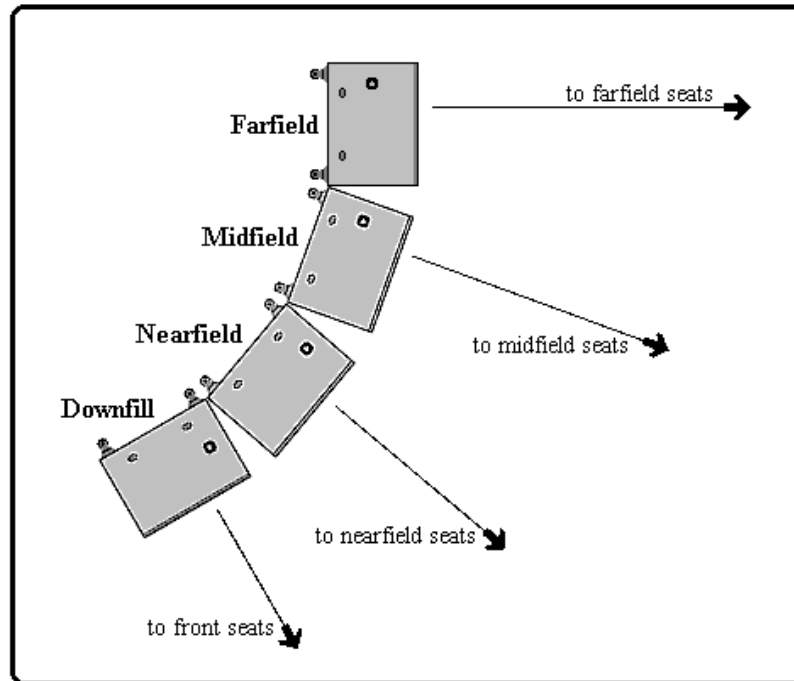

In a narrower venue, we may require the outer sections to be attenuated a little, particularly in the farfield section, as follows:

Farfield Inner	0dB (fully cw)
Farfield Outer	-3dB (fully cw)
Midfield Inner	-2dB
Midfield Outer	-4dB
Nearfield Inner	-4dB
Nearfield Outer	-5dB
Downfill Inner	-6dB (front row centre)
Downfill Outer	-5dB (front row outers)

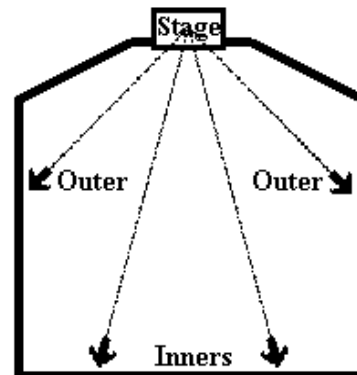

A1.5 DX1 Loudspeaker Management System



Martin Audio can provide factory set configuration cards for a variety of off-the-shelf crossover systems (contact your dealer or Martin Audio Ltd for further information) but the Martin Audio DX1 Loudspeaker Management System is strongly recommended for all new Wavefront system designs.

The Martin Audio DX1 is a very high performance DSP-based controller and provides crossover, protection, delay and alignment functions. As a Martin Audio product, the DX1 is kept up-to-date with preset crossover and limiter functions suitable for a wide range of system configurations and power amplifiers.

Preset Number	Loudspeaker system	Config.	Input A	Input B	Output 1	Output 2	Output 3	Output 4	Output 5	Output 6
20	W8 (passive) + WSX	2x3 way	o/p 1 to 3	o/p 4 to 6	WSX sub	W8 Low	W8 Mid/HF	WSX sub	W8 Low	W8 Mid/HF
21	W8 (active) + WSX	1x4 way	o/p 1 to 4	o/p 5 to 6	WSX sub	W8 Low	W8 Mid	W8 High	Aux	Aux
22	W8 (passive) + W8S (passive)	2x3 way	o/p 1 to 3	o/p 4 to 6	W8S sub	W8 Low	W8 Mid/HF	W8S sub	W8 Low	W8 Mid/HF
23	W8 (active) + W8S (passive)	1x4 way	o/p 1 to 4	o/p 5 to 6	W8S sub	W8 Low	W8 Mid	W8 High	Aux	Aux
24	W8 + W8S (all active)	1x5 way	o/p 1 to 5	o/p 6	W8S 18	W8S 15	W8 Low	W8 Mid	W8 High	Aux
25	W8 (active) with HF Lift + WSX	1x4 way	o/p 1 to 4	o/p 5 to 6	WSX sub	W8 Low	W8 Mid	W8 High	Aux	Aux

DX1 Factory Preset Examples

W8 Rear panel Active/Passive switch

Please note that the W8 rear connector panel is equipped with an Active/Passive switch.

Active mode (DX1 factory presets 21, 23, 24 or 25)

In *Active* mode each driver (low-mid, high-mid & high) is driven by its own power amplifier channel. These power amplifier channels are sourced from the appropriate DX1 output to ensure optimal crossover and limiter alignment.

The advantages of active mode are:

- Smoother high-mid/high amplitude and phase response
- Smoother high-mid/high vertical polar response
- Improved high-mid/high amplifier headroom
- Improved high-mid/high limiter action

Three Martin Audio MA2.8 power amplifiers will drive four W8s (assuming W8s

driven in pairs).

Passive Mode (DX1 factory presets 20 & 22)

In *Passive* mode the W8 high-mid and high drivers share a power amplifier channel via a passive high-mid/high crossover network built into the loudspeaker cabinet. This mode offers a slightly reduced performance but requires only two power amplifier channels per 3-way W8 system.

Two MA2.8s and will drive W8s (assuming W8s driven in pairs).

The following shows the DX1 with programme 20 selected. This caters for a stereo set-up comprising left and right W8s in *Passive* mode plus separate left and right WSX folded-horn subwoofers. For more WSX information see [Section 4](#).

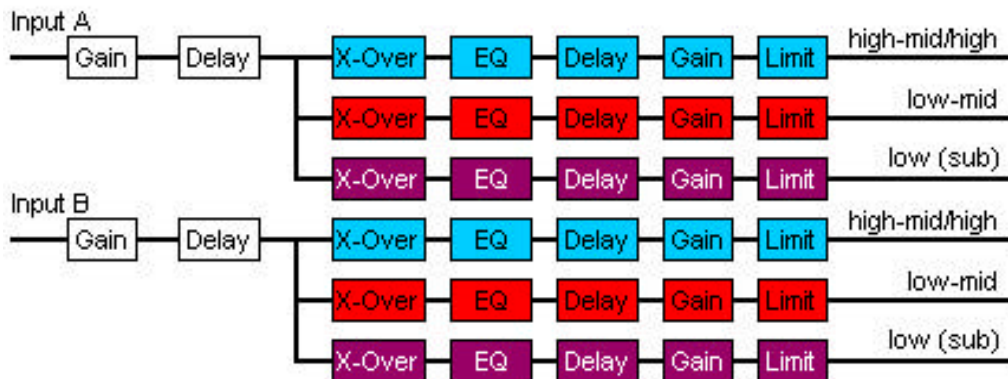

DX1 factory preset 20 (2 x 3 way configuration)
Stereo W8 system (passive) with WSX subwoofers

Custom DX1 set-ups

Experienced users may create custom DX1 set-ups, for example...

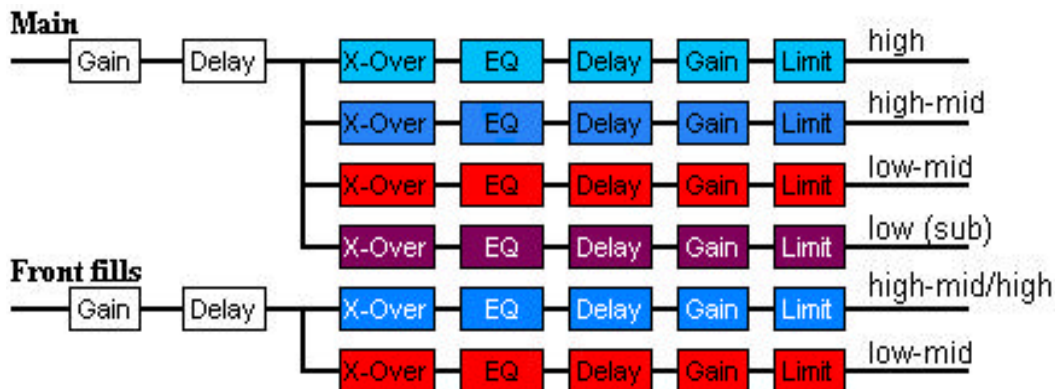

3 + 2-way configuration
e.g. W8 3-way system with W8S subs (passive) & W8 (passive) front fills

A1.5.1 DX1 specifications

Inputs	2 electronically balanced. >10k ohms
CMRR	>65dB 50Hz - 10kHz
Outputs	6 electronically balanced. <60 ohms
Min. Load	600 ohm
Max. Level	+20dBm into 600 ohm load
Frequency Resp.	±0.5dB 20Hz - 20kHz
Dynamic Range	>110dB 20Hz -20kHz Unwtd
Distortion	<0.02% @ 1kHz, +18dBm
Maximum Delay	650mS. (Increment 2.6uS)
Output gain	adjustable +15dB to -40dB in 0.1dB steps and mute
Input gain	adjustable +6dB to -40dB in 0.1dB steps

Parametric Equalisation

Filters	5 Sections per output
Filter gain	+15dB to -30dB in 0.1dB steps.
Centre frequency	0Hz - 20kHz, 1/36 octave steps (368 positions)
Filter Q / BW	0.4 to 128 / 2.5 to 0.008
(Sections switched to shelving response)	
Low frequency	20Hz - 1kHz
High frequency	1kHz - 20kHz
Shelf gains	±15dB in 0.1dB steps

Crossover (high-pass and low-pass) filters

Filters	1 of each per output
Frequency (HPF)	10Hz - 16kHz, 1/36 octave steps
Frequency (LPF)	60Hz - 22kHz, 1/36 octave steps
Response	Bessel / Butterworth 12/18/24dB per octave Linkwitz-Riley 24dB per octave

Limiters

Threshold	+22dBu to -10dBu
Attack time	0.3 to 90 milliseconds
Release time	4, 8, 16 or 32 times the attack time
Power required	60 to 250V ±15% @ 50/60Hz. < 20W
Weight	3.5kg. Net (4.8kg. Shipping)
Size	44 (1U) x 482 x 300mm excluding connectors

1.5.2 DX1 Output Gain and Limiter settings for the W8

Standardising on one good model of power amplifier (preferably the [Martin Audio MA2.8](#)) and correctly set-up controller (preferably the [Martin Audio DX1](#)) will provide the most dynamic system performance and protection whilst simplifying design and reducing spares inventories.

Gain settings

The following DX1 output gain settings will enable full system performance to be obtained whilst keeping the console and drive system noise floors inaudible and avoiding amplifier slew-rate limiting:

W8 - assuming 300Wcont - 600Wpk into 8Ω power amplifiers:						
Best-fit Amplifier Example	Amplifier Sensitivity		Amplifier Gain dB	Initial DX1 Output <u>GAIN</u>		
	dBu	Vrms		Lomid	Himid	High
	dB		dB	dB	dB	dB
Martin MA2.8* (38dB)	-2	0.62	38	-9	-9	-7
Crest CA9 (x68)	-1	0.69	37	-8	-8	-6
Crown MA1202 (0.775v)	0	0.77	36	-7	-7	-5
	+1	0.87	35	-6	-6	-4
QSC PL224	+2	0.98	34	-5	-5	-3
	+3	1.09	33	-4	-4	-2
Martin MA2.8* (32dB)	+4	1.23	32	-3	-3	-1
Crest 4801 (x40)	+4	1.23	32	-3	-3	-1
Crown K1 (1.4v)	+4	1.23	32	-3	-3	-1
QSC PL218/218A (32dB)	+4	1.23	32	-3	-3	-1
QSC PL224A (32dB)	+4	1.23	32	-3	-3	-1
Crown MA1202 (1.4v)	+5	1.38	31	-2	-2	0
	+6	1.55	30	-1	-1	+1
	+7	1.73	29	0	0	+2
	+8	1.95	28	+1	+1	+3
	+9	2.18	27	+2	+2	+4
Crown MA1202 (26dB)	+10	2.45	26	+3	+3	+5
Crown K1 (26dB)	+10	2.45	26	+3	+3	+5
QSC PL218A (26dB)	+10	2.45	26	+3	+3	+5
QSC PL224A (26dB)	+10	2.45	26	+3	+3	+5

* Set Martin Audio MA2.8 rear MLS switch to **-2dB** to match peak output of unregulated power amplifiers.

Cluster balance (eg farfield-to-nearfield or inner-to-outer) should be adjusted **at the power amplifier controls** to maintain limiter tracking. See [Section A1.7](#).

Balancing the system using gain controls in the signal path *before* the power amplifiers will cause the higher signal level upper row of a big cluster to start limiting before the lower signal levels downfills causing tonal changes at the mix position.

Limiters settings

The Rated Power specifications in [Section A1.2](#) show that the maximum allowable power dissipation depends on the driver/s being driven. This is because big low and low-mid drivers are capable of dissipating more heat than smaller high-mid and high drivers.

Normal music and speech signals, however, are a combination of relatively low general power levels with a multiplicity of short term transients. These short term transients do not significantly heat the driver voice coils so it is quite permissible to use the same 250-300W into 8Ω (500-600W into 4Ω) power amplifiers for all sections of the W8 [as long as they are sourced by a correctly set controller.](#)

When choosing power amplifiers, do not be tempted to exceed the 250-300W into 8Ω (500-600W into 4Ω) power rating unless the amplifier's power rails are well regulated (see [Section A1.6](#)) - even with properly set controllers in place.

Although Martin Audio drivers are mechanically designed to survive normal road use and the occasional operator error, over-powered or bridged amplifiers can cause over-excursions that stress and age drivers. The best way to get the clean, relaxed sound of an overpowered amplifier is to choose an amplifier with plenty of current reserve - ie an amplifier with good 2Ω specification - and avoid running more than two cabinets in parallel.

To ensure transparent limiter operation without obvious distortion or pumping, the DX1 limiter attack and release times are factory preset to be inversely proportional to each band's high pass frequency as follows:

High pass filter range	Attack time	Release time
>31Hz	45mS	720mS
31Hz - 63Hz	16mS	256mS
63Hz - 125Hz	8mS	128mS
125Hz - 250Hz	4mS	64mS
250Hz - 500Hz	2mS	32mS
500Hz - 1KHz	1mS	16mS
1KHz - 2KHz	0.5mS	8mS
2KHz - 22KHz	0.3mS	4mS

These attack times will allow the power amplifiers to clip momentarily but not for long enough to be obvious to listeners or cause driver overheating. It is quite normal to see amplifier clip indicators on the odd programme peak but continuous clipping would indicate a cable short circuit, wrong controller settings, excessive power amplifier gain or low mains voltage.

The following DX1 output limiter settings will avoid voice coil overheating and minimise amplifier clipping for high quality, trouble free operation.

W8 - assuming 300Wcont - 600Wpk into 8Ω power amplifiers:						
Best-fit Amplifier Example	Amplifier		Amplifier Gain dB	Recommended DX1 <u>LIMITER</u>		
	Sensitivity dBu	Vrms		Lomid dBu	Himid dBu	High dBu
<u>Martin MA2.8* (38dB)</u>	-2	0.62	38	-3	-6	-9
Crest CA9 (x68)	-1	0.69	37	-2	-5	-8
Crown MA1202 (0.775v)	0	0.77	36	-1	-4	-7
	+1	0.87	35	0	-3	-6
QSC PL224	+2	0.98	34	+1	-2	-5
	+3	1.09	33	+2	-1	-4
<u>Martin MA2.8* (32dB)</u>	+4	1.23	32	+3	0	-3
Crest 4801 (x40)	+4	1.23	32	+3	0	-3
Crown K1 (1.4v)	+4	1.23	32	+3	0	-3
QSC PL218/218A (32dB)	+4	1.23	32	+3	0	-3
QSC PL224A (32dB)	+4	1.23	32	+3	0	-3
Crown MA1202 (1.4v)	+5	1.38	31	+4	+1	-2
	+6	1.55	30	+5	+2	-1
	+7	1.73	29	+6	+3	0
	+8	1.95	28	+7	+4	+1
	+9	2.18	27	+8	+5	+2
Crown MA1202 (26dB)	+10	2.45	26	+9	+6	+3
Crown K1 (26dB)	+10	2.45	26	+9	+6	+3
QSC PL218A (26dB)	+10	2.45	26	+9	+6	+3
QSC PL224A (26dB)	+10	2.45	26	+9	+6	+3

* Set Martin Audio MA2.8 rear MLS switch to -2dB to match peak output of unregulated power amplifiers.



Use lower limiter settings (or more loudspeakers!) if your power amplifiers indicate clipping on more than just the odd peak. Excessive clipping may also be caused by cable faults or an inadequate mains supply. [See Section A1.6.](#)

The DX1 may be user-programmed to many more touring and fixed installation configurations based on its 2 input + sum, 6 output matrix. This operation is best completed by an audio technician who is familiar with DSP-based pro-audio.

(See separate [DX1 Speaker Management System User's Guide](#) for details)

A1.6 Power amplifier recommendations

Wavefront Series loudspeaker systems have been designed and manufactured for very high performance and arrayability. The systems are very easy to use - particularly if power amplifier racks and controller settings are standardised within a system.

Power capability

The Wavefront W8 will provide full performance when driven by professional power amplifiers capable of delivering undistorted output power into a range of loads as follows:

W8

250-300W(AES) into 8 ohms,
500-600W(AES) into 4 ohms
and
1,000-1,200W(AES) into 2 ohms.

Please note:

Amplifiers with inadequate headroom before clipping may age high frequency components due to excessive signal density.

Amplifiers with excessive output may damage voice-coils or age driver suspensions due to excessive heat dissipation and excursion.

A note about power amplifier output specifications

Most power amplifier manufacturers keep their costs down by using unregulated supply rails which sag under load. To allow for this sag, manufacturers set their rails high so that they still meet their quoted output into specified loads. These high rail voltages allow such power amplifiers to provide outputs 1.5 - 2 times their quoted power for short-term bursts. Martin Audio products will withstand this potential doubling of instantaneous power - with suitably set controller limiters - but further, long-term increases caused by oversized amplifiers should be avoided.

Martin Audio MA Series Power Amplifiers

Martin Audio MA Series amplifiers have regulated rails so it is quite permissible to use slightly overpowered models - with suitably set controller limiters - without risking uncontrolled power bursts. The MA series power amplifiers' regulated power

rails also ensure maximum performance under the real-world concert conditions of less-than-optimum mains supplies and parallel cabinets. [See Section A1.6.1.](#)

Most non-Martin power amplifiers' 4 ohm performance figures are specified assuming very well regulated bench supplies but fail to reach these specifications under touring conditions. These amplifiers can be a totally false economy as they cannot drive parallel cabinets without a very audible loss of headroom and quality.

Amplifier load tolerance

An efficient loudspeaker in live concert conditions can act as a surprisingly dynamic and complex load. Most modern touring power amplifiers claim 2 ohm capabilities but make sure your amplifier is also capable of driving reactive (ie inductive or capacitive) loads without prematurely clipping or developing output stage crossover distortion.

Mains safety!

A fully qualified technician should check mains safety and phase voltage *before* the system is patched.

Power reserve

Power amplifier specifications are usually based on bench measurements made using stable, high current mains supplies and well defined loads. Amplifiers sound best when they have plenty of current in reserve for musical peaks.

- 1) Try to ensure that the mains supply stays within the amplifier manufacturer's specified range from no load to maximum load. An electrical technician should check the mains supply vs demand using an accurate rms voltage meter.
- 2) If unfamiliar generators are being used the electrical technician should check the mains waveform (using a portable 'scope-meter) to make sure that it is sinusoidal and not crawling with spikes or interference.
- 3) Avoid driving too many W8s in parallel. I would suggest no more than two so that the amplifier's 2Ω spec is kept in reserve for musical peaks.
- 4) Avoid using power amplifiers in bridged mode. Most commercial power amplifiers are optimised for 2-channel operation. It is usually better to use the appropriate amplifier in 2-channel mode than to use an inadequate amplifier in bridged mode.

Gain or level settings

Gain switches

If you are lucky enough to have amplifiers with user gain switches, set them all to identical positions. A voltage gain in the range 23-33dB will provide a good balance of system headroom and noise (assuming professional audio equipment is in use FOH).

Level controls

The front panel level controls should be turned down (fully counter clockwise) until FOH-to-Amp rack lines have been checked and controllers have been set to suit the power amplifiers to be used (see [Section A1.5.2](#)). Music should be used to check that controllers are receiving and sending the appropriate signal bands and then each power amplifier level control advanced in sequence to check system operation and patching.

Assuming that controller output levels and limiters have been set as tabulated in [Section A1.5.2](#), power amplifier level controls should be set to full (fully clockwise) for loudspeaker sections requiring the strongest drive. Amplifiers driving nearer-field sections within the same cluster may be backed off as required for smooth coverage. This process will ensure that the system remains balanced during limiting.

Rack mounting

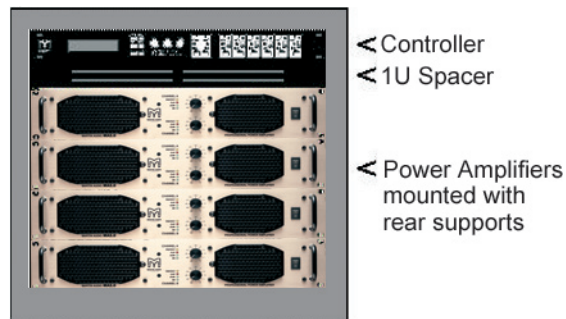

Always leave a 1U space between power amplifiers and controllers. Although most modern amplifiers don't radiate significant fields it's better to play safe and keep the system quiet. Rear supports are recommended - check with the manufacturer.

A1.6.1 Martin Audio MA2.8 Overview



Features

- Switch mode power supply
- Superior sonic performance
- Light weight
- Advanced protection circuits
- Efficient copper cooling system
- Minimum load switches (MLS™)

The MA2.8 power amplifier has been designed to combine reliability and high power output with sonic excellence. Utilising an advanced switch mode power supply, the MA2.8 yields a very high power-to-weight ratio in a lightweight, 2U package.

See [MA2.8 Amplifier User's Guide](#) for detailed operating instructions.

Cooling System

The Martin Audio MA2.8 amplifier runs very cool due to a special patented copper cooling system. The amplifier's bi-polar output devices are mounted directly onto a copper heat sink (copper conducts heat twice as efficiently as aluminium) and maximum heat dissipation is achieved by turbulent airflow over the heatsink's geometric fins.

The MA2.8 amplifier features two proportional speed cooling fans which take in air from the front of the amplifier and exhaust from the rear. A horizontal pressure chamber between the heatsink and the cooling fans ensures that there is little difference in the operating temperatures of each output device. In contrast, a conventional tunnel design can result in a temperature variance of up to 40° between output devices.

Switch Mode Power Supply

The MA2.8's switch mode power supply (SMPS) is the modern solution to the problems of size and weight. Switch mode power supplies are not new - they are found in computers and televisions. However, the demands of high power audio are very different to these applications. The MA2.8 overcomes the size and weight constraints of conventional power supplies whilst at the same time avoiding the pitfalls of typical switch mode designs.

The low output impedance of the SMPS means that rail voltages do not sag under heavy load conditions. Additionally, the rail capacitors are being recharged at a much faster rate than those in a conventional power supply. The result is an exceptional fast transient low frequency performance at all power levels. Efficiency is also maximised. With much smaller transformers than a conventional supply, there is much less loss due to transformer resistance and much less power wasted as heat in the power supply.

The power amplifier will produce the same power output, even if the AC line voltage drops by 20%.

Minimum Load Switches (MLS™)

Because the SMPS is regulated, the maximum power available for the output stages can be adjusted without increased heat dissipation or efficiency loss. This allows the user to match the output power with the loudspeaker impedance.

Protection

The MA2.8 amplifier has many advanced protection features that will protect both the amplifier and the speakers connected to it, under fault conditions. All protection circuits are independent and inaudible in normal use.

Clip Limiters

Clip limiters prevent dangerous clipped signals reaching the speaker. They work by monitoring the output to check for signals not present at the input i.e. distortion. If distortion exceeds 1% on an output, the limiter will reduce the input signal proportionally.

Thermal Protection

Thermal Protection circuitry prevents the amplifier from running at an unsafe temperature by muting the input signal when the internal temperature rises above 90°C.

Short Circuit Protection

The MA2.8 amplifier is completely short circuit protected. The protection circuits permit very high peak currents, but maintain the output devices within their safe operating area.

Mains Voltage Protection

This operates if the mains voltage falls outside its permitted operating range. If this occurs, the power supply will shut down until the correct mains voltage is restored.

DC and VHF Protection

Both DC voltages and high power VHF signals can cause damage to loudspeakers. The MA2.8 amplifier incorporates protection circuits which are activated when damaging DC voltages or VHF signals are present at the outputs.

MA2.8 Specifications

Input Impedance	20kohms (balanced) 10kohms single ended
Gain select switch	38dB (I/P sens 0.775V), 32dB (I/P sens 1.55V)
CMRR at 1kHz	>50dB
Output impedance at 1kHz	0.06 ohms
Power Bandwidth	10Hz - 20kHz
Slew rate	20V/us
Hum/Noise	<-105dB
Channel Separation	1Khz > 90dB 10Khz > 80dB
Mains Operating Voltage	120 - 270 (minimum start voltage 190) full output power maintained 180 - 280V Optional (65 - 135V) operation
Protection	DC, High temperature, Turn on, VHF, Over and under voltage, Clip limiters. Short circuit
Distortion	
THD 20Hz - 20kHz and 1W – 1000W	4 ohms 0.08% 4 ohms 0.03%
THD at 1kHz and 1100W	4 ohms 0.02%
DIM 30 at 500W	4 ohms 0.03%
CCIF (13 and 14 kHz) at 500W	4 ohms 0.08%
SMPTE (60Hz and 7kHz) at 500W	
Power Matrix	

MLS SWITCH SETTING

LOAD CONFIGURATION	(-5dB)	(-4dB)	(-2dB)	(0dB)
16 ohms Stereo (2 channel)	160W	180W	340W	520W
8 ohms Stereo (2 channel)	300W	350W	650W	1100W
4 ohms Stereo (2 channel)	570W	680W	1100W	1400W
				1900W[2]
2 ohms Stereo (2 channel)	1040W	1200W	1200W	1400W[1]
			1400W[2]	2900W[2]
16 ohms Bridged mono	600W	700W	1300W	2000W
8 ohms Bridged mono	1200W	1400W	2200W	2800W
4 ohms Bridged mono	2100W	2400W	2400W	2800W[1]

[1] = Component tolerance dependent

[2] = Continuous power, one channel driven or peak power both channels driven. Thermal protection may occur at high continuous power.

Power in watts (EIA 1kHz, 1% THD)

Weight

10kg (22lbs)

Dimensions

(W) 483mm x (H) 88mm x (D) 347mm
(W) 19ins x (H) 3.5ins x (D) 13.7ins

A1.7 General operational summary

- 1) Always use the same model system controller and power amplifier for a particular Wavefront product. This avoids confusion caused by different controller topologies and power amplifiers voltage gains.
- 2) It is common practice to use mixing console matrix outputs as loudspeaker section controls. Whilst this is fine for creating a bass submix which can easily be judged from the mix position, it can be fraught with danger if used for audience sections which may only be audible in very specific areas. Trim these remote sections, during listening tests with a colleague via walkie talkie, using the relevant controller input gains. If the console matrix cannot be avoided, try to pre-calibrate its output levels controls to their 0dB (nominal) position initially. These settings will be easier to get back to and will avoid embarrassing level setting mistakes during the show - particularly if the system is being used by guest operators who may not be familiar with your particular matrix allocations.
- 3) And again, trim levels within clusters (eg farfield vs midfield or inners vs outers) using the amplifier level controls to ensure limiter tracking.

A1.8 Arraying & placement

Simple stacked systems

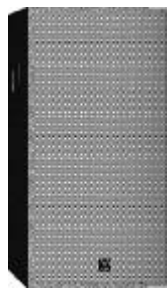

Single W8

A single Wavefront W8 cabinet will cover 55° horizontally x 30° vertically and may be used as a stand-alone system for a variety of light music and voice applications including commercial presentations.

A W8 may be combined with a W8S compact subwoofer or a WSX horn-loaded subwoofer to extend its low frequency performance.

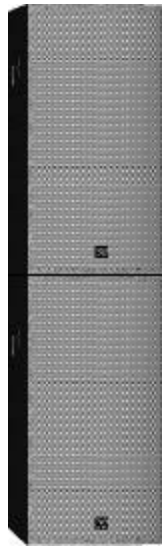

Single W8 on W8S subwoofer

This very compact stack may be used as one side of a main system for a folk band concert in a small venue, one corner of a small dance floor system, stage side fills, stage drum fills, front fills etc.

SAFETY REMINDER!

Stacks should always be safety strapped to allow for high winds, over-exuberant artists, crowd indiscipline, scenery movements etc.

Wide coverage, broadband stack

Although a single Wavefront W8's horizontal coverage is 55° at high frequencies, the system has been designed to integrate well with smaller splays for practical output summing. A splay of 40° between axes (260mm between cabinet front corners) provides very smooth 95° horizontal coverage with little increase in mid-band output level whilst a smaller splay angle can boost the forward output level by 2-3dB.



2-wide W8/W8S ground-stack

This very compact stack may be used for as one side of a small venue main system, one corner of a dance system, high power stage side fills, drum fills, centre fills etc.

Flown systems overview

Flown clusters are recommended for very high power music systems covering large venues to ensure adequate coverage without excessive levels at the front of the venue.

Wavefront series products are fitted with MAN load-certified flying points and are designed to comply with the 12:1 safety factor specified by the German VBG70 standard when used with compatible 12:1 flying systems.

MAN Transformer or Installer/Tourer flying systems allow columns of loudspeakers to be assembled by attaching individual loudspeakers to vertically daisy-chained D-rings using keyhole cabinet fittings - hence the tendency to base flown designs in this applications guide on multiple columns. The beauty of the MAN system is that each cabinet in a system supports only its own weight.

See [Section 1.8](#) for further details and illustrations.

Rigging Schools!

Rigging should not be undertaken by untrained or unqualified personnel.

Suitable rigging training sessions may be arranged by calling Martin Audio Ltd on +44 (0)1494 535312.

Important note on flown systems examples

Wavefront cluster examples are included in this manual to illustrate recommended loudspeaker combinations and splay angles only. Note that very large clusters - particularly those including Wavefront Longthrow elements - may need to be flown in multiple layers to maintain the 12:1 safety factor of the standard Martin Audio Wavefront 8 Flying System.

A1.9 Coverage calculations

Single W8 column

Here is an example of a 1-wide, 3 deep column of Wavefront W8s.

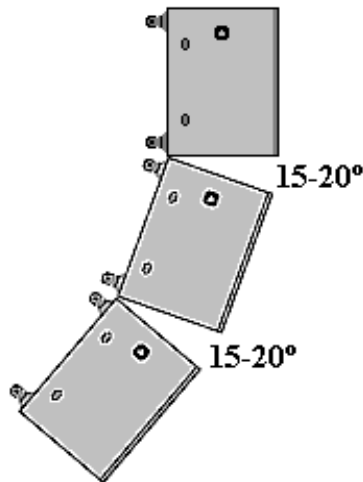

Vertical splay angles

The horizontal coverage is, of course, that of a single W8 ie 55°.

The vertical coverage of a W8 cluster can be calculated as follows:

Vertical coverage of a W8 = the vertical coverage of a single W8 (30°) + the sum of all the vertical splay angles

For a 3-deep W8 cluster with 15° vertical splay angles = $30^\circ + 15^\circ + 15^\circ = 60^\circ$

For a 3-deep W8 cluster with 20° vertical splay angles = $30^\circ + 20^\circ + 20^\circ = 70^\circ$

Double W8 column

Here is a 2 wide, 4 deep column of Wavefront W8s.

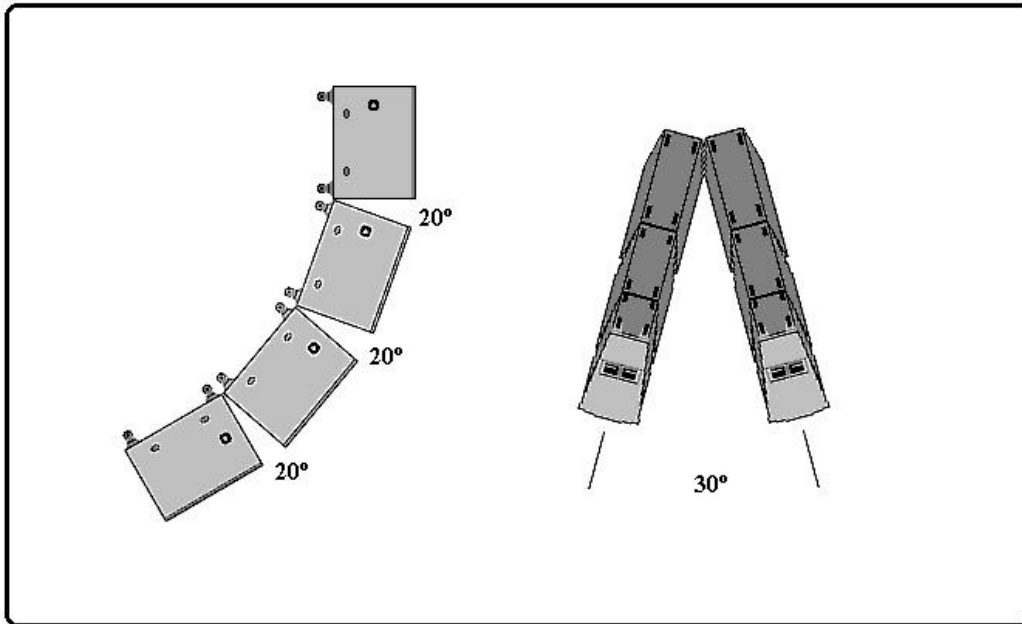

Vertical coverage of a W8 cluster = the vertical coverage of a single W8 (30°) + the sum of all the vertical splay angles

For a 4-deep W8 cluster with 20° vertical splay angles = $30^\circ + 20^\circ + 20^\circ + 20^\circ = 90^\circ$

Horizontal coverage of a W8 cluster = the horizontal coverage of a single W8 (55°) + the sum of all the horizontal splay angles

For a 2-wide W8 cluster with 30° horizontal splay angles = $55^\circ + 30^\circ = 85^\circ$

Wide coverage cluster

4 or 6 wide, 4 deep W8 clusters may be rigged for very wide coverage. Coverage may be calculated as follows:

6 wide cluster

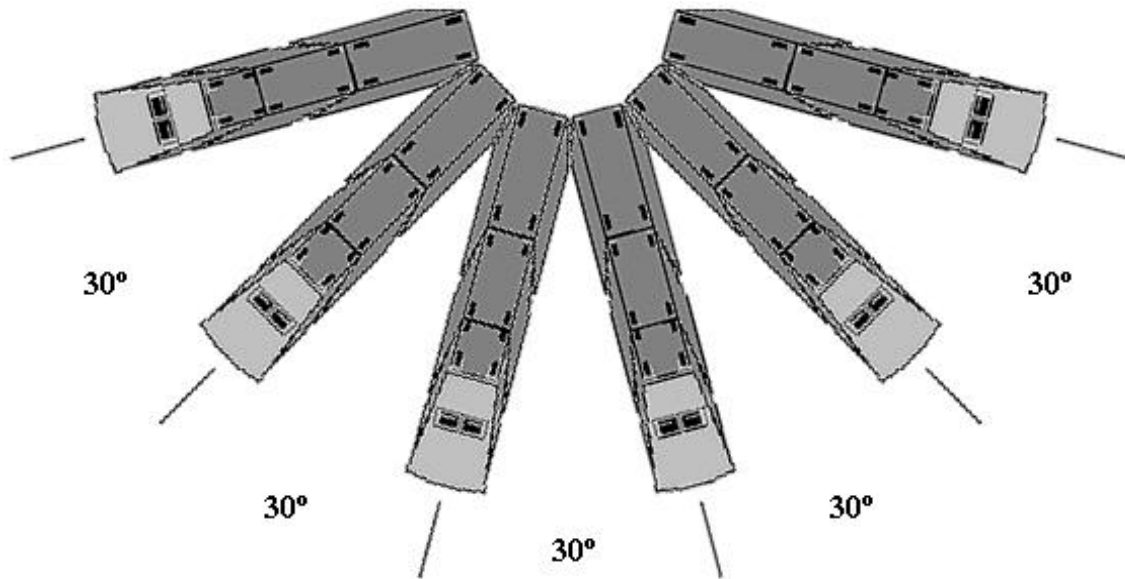

6 wide, 4 deep plan view

The horizontal coverage now extends to:

$$55^{\circ} + 30^{\circ} + 30^{\circ} + 30^{\circ} + 30^{\circ} + 30^{\circ} = 205^{\circ} \text{ for } 30^{\circ} \text{ horizontal splays}$$

and the vertical coverage extends to:

$$30^{\circ} + 20^{\circ} + 20^{\circ} + 20^{\circ} = 90^{\circ} \text{ for } 20^{\circ} \text{ vertical splays}$$

Circular cluster

Two 6-wide, 4 deep W8 clusters with 30° horizontal splay angles and 20° vertical splay angles may be flown back-to-back to provide full 360° horizontal x 90° vertical coverage for, for example, ice shows.

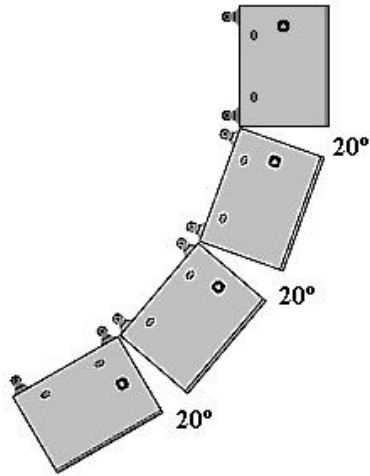

Column View

Note that the 90° coverage allows foldback to be provided to the ice-dancers. The centre hole may be filled by flying a smaller cabinet underneath the main cluster.

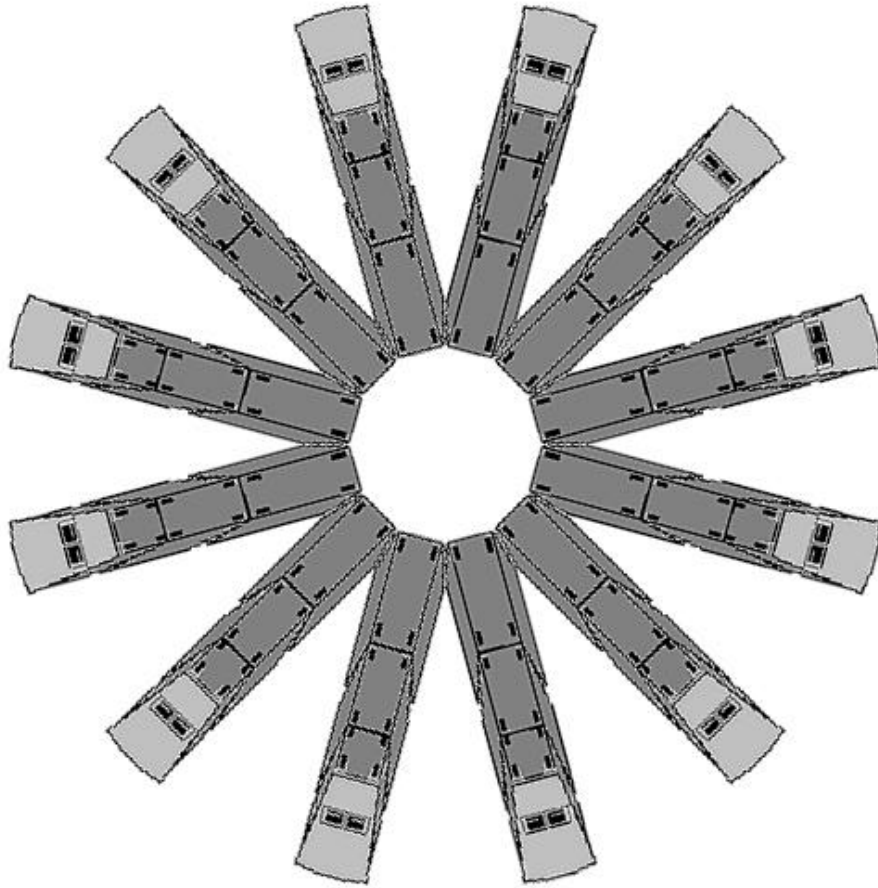

Circular, 4-deep W8 cluster

A1.10 W8s as front fills

Wavefront W8s may be used as stage apron fills for high power rock concerts. When carefully placed on radii converging at the centre downstage (lead vocal) area and synchronised with the main PA downfills, these apron fills don't just balance the subwoofers. They can focus vocals and add a detailed quality that can be beneficial right out to the mix position.

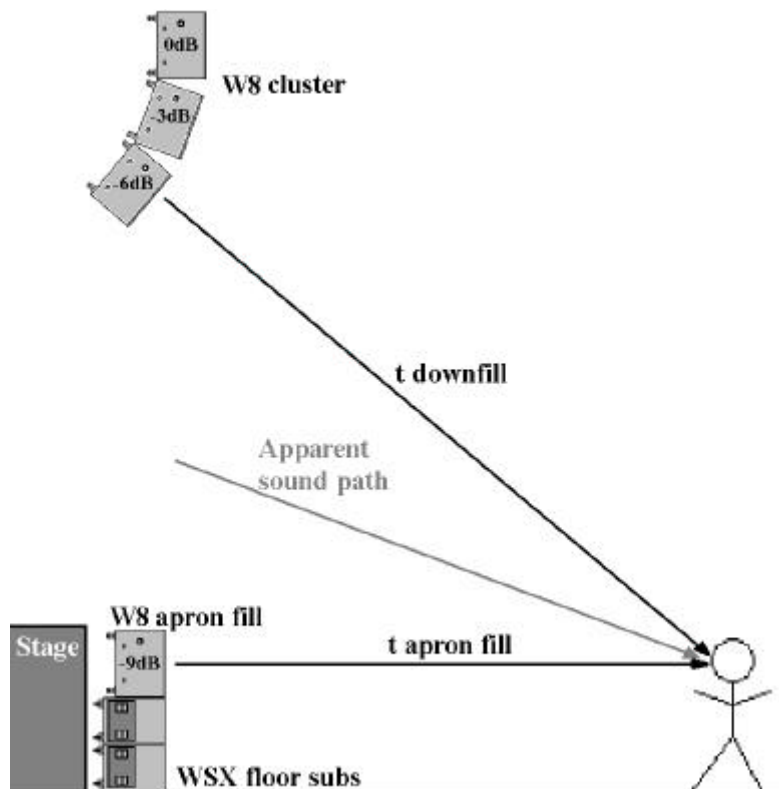
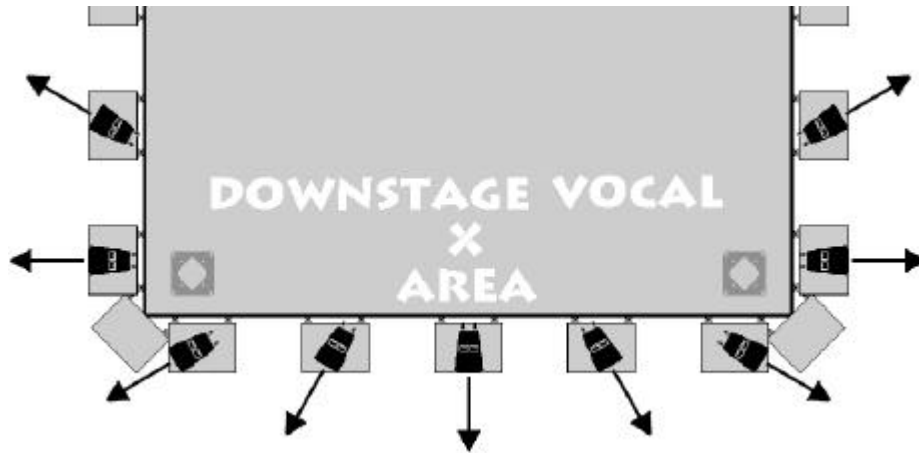

If the apron fill loudspeaker signal is delayed by the difference between the downfill propagation time and the apron fill propagation time and attenuated by the ratio of

those propagation times, the sound will appear to come from an area in between the two systems for the listener shown.

$$\text{Apron fill delay line setting} = t_{\text{downfill}} - t_{\text{apron fill}}$$
$$\text{Apron fill gain setting wrt downfill gain} = 20\log^{10}(t_{\text{downfill}} \div t_{\text{apron fill}}) \text{ dB}$$

A1.11 W8s as side clusters

A Wavefront Longthrow (See [Section 2](#)) centre cluster may be used with W8 downfills for efficient operatic and orchestral amplification. Velodrome side seats can be some distance away (typically across a wide cycle track) so fairly powerful side clusters may be required for good projection and intelligibility.

W8s blend in sonically without off-axis lobing and stage mic colouration.

Deep orchestral stage continues this way ↑

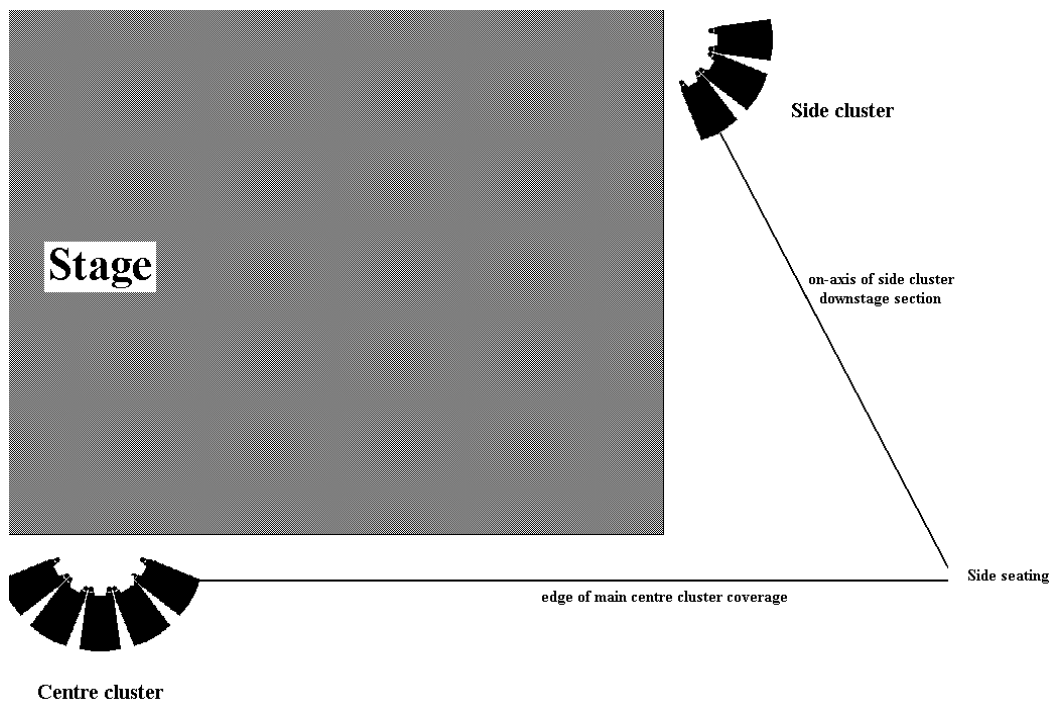

To avoid abrupt changes in timbre between the side and centre cluster, the side downstage W8 axis should be aimed at the seating where the centre cluster is *just* beginning to lack very high frequencies.

Controller output levels and delays should be adjusted so that the side and centre clusters are at the same level and synchronised in the same area.

A1.12 W8s in distributed (delay) systems

Wavefront W8s make very good high power distributed systems or delay elements as they project sound smoothly and efficiently without local off-axis lobing.

For good overall coverage, delays are best driven in mono for most of the show although computer controlled matrix mixes may be considered for panning spot effects around the venue.

Flown radial delays

Flown distribution or delay loudspeakers should be placed on radii converging at the stage and staggered for smooth coverage.

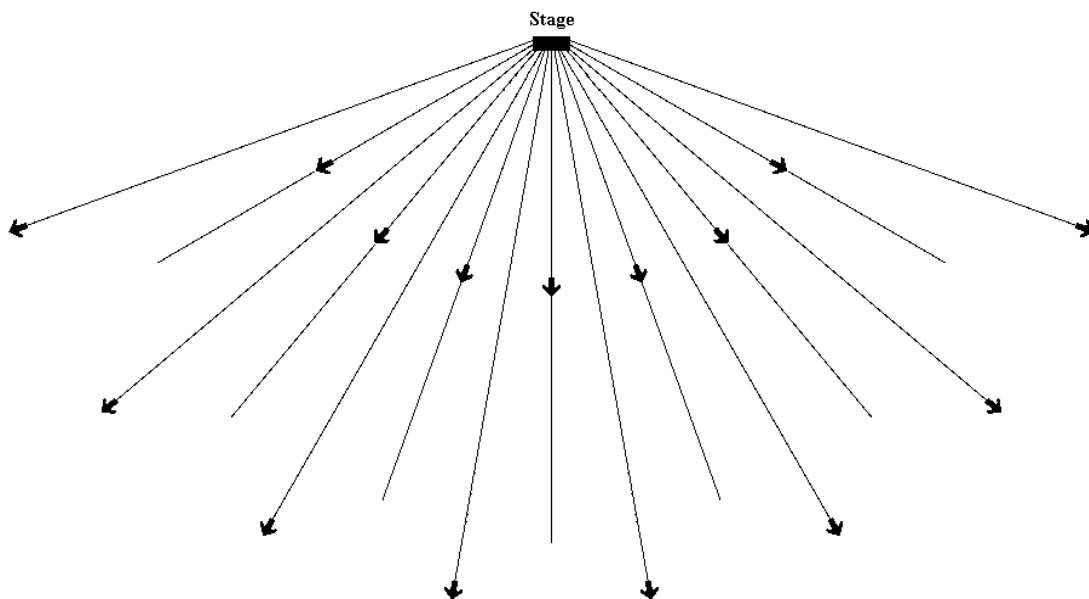

Distributed flown loudspeaker plan (stage system not shown)

Delay times should be set for synchronisation with the next most powerful source. This would be the stage for the first row of delays (below left) or the previous row (below right) for farfield delays.

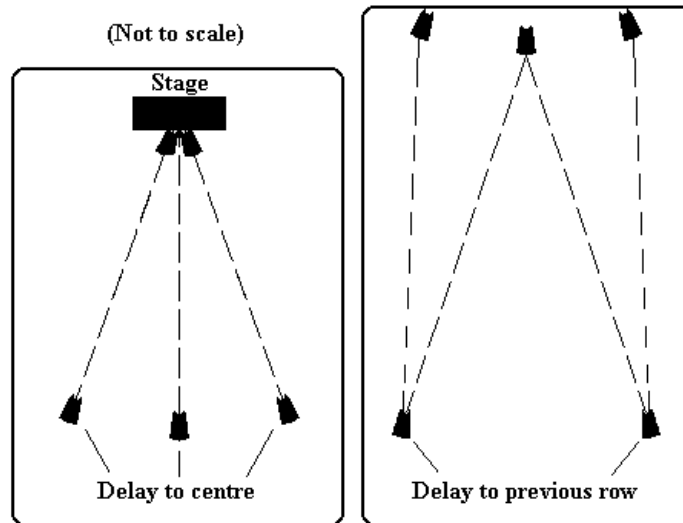

Synchronising flown central delays

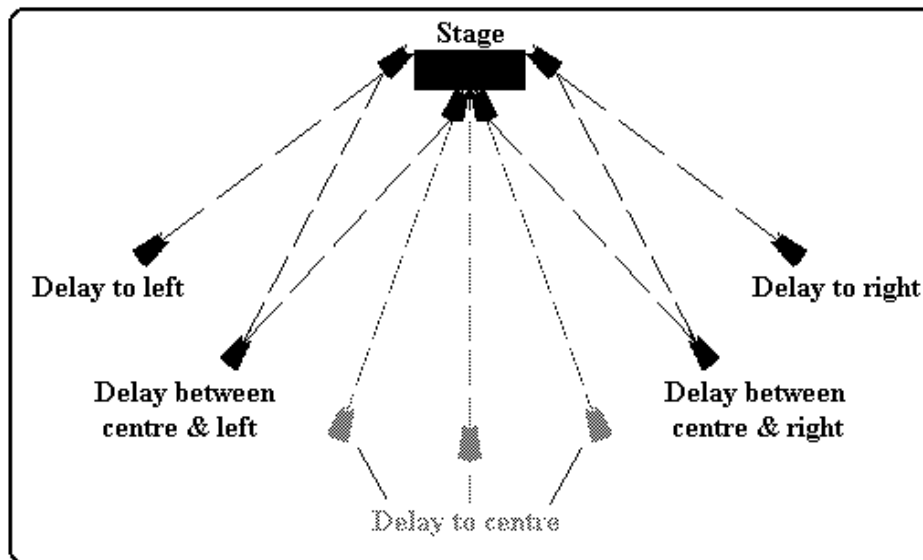

Synchronising flown outer delays

Ideally, the sound should be perceived as coming from the stage over the whole audience area - which means that all the delay loudspeakers should be aligned with the stage opening. In practice, sight line, follow spot and camera shot restrictions will affect placement for heavily raked seating areas and intelligent compromises will need to be made.

Delay systems should be thoroughly checked over a wide listening area to ensure that their level settings provide smooth coverage without hot spots. Delay times and levels should be finely adjusted to minimise multiple arrivals in seating areas where systems cannot be in line with the stage and more than one source can be heard.

Aiming delay tower loudspeakers

Multiple delay tower loudspeakers should be tilted so that they aim towards head height at the next tower to mask off-axis tower leakage and to minimise multiple arrivals further out.

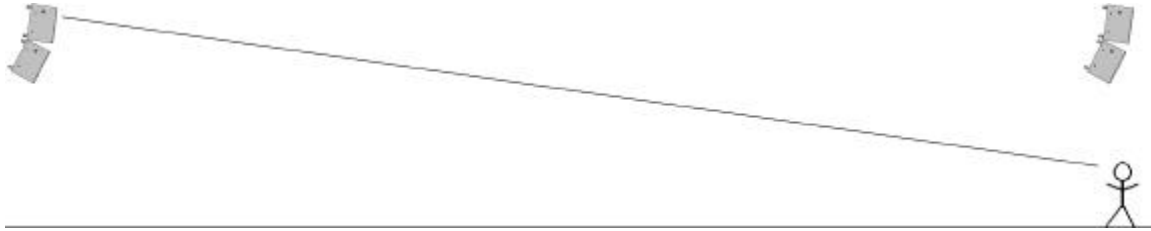

Synchronising multiple tower systems (not to scale)

Small delay time errors are inevitable where delay towers are located in audience areas (eg on a football field) due to the three dimensional geometry involved.

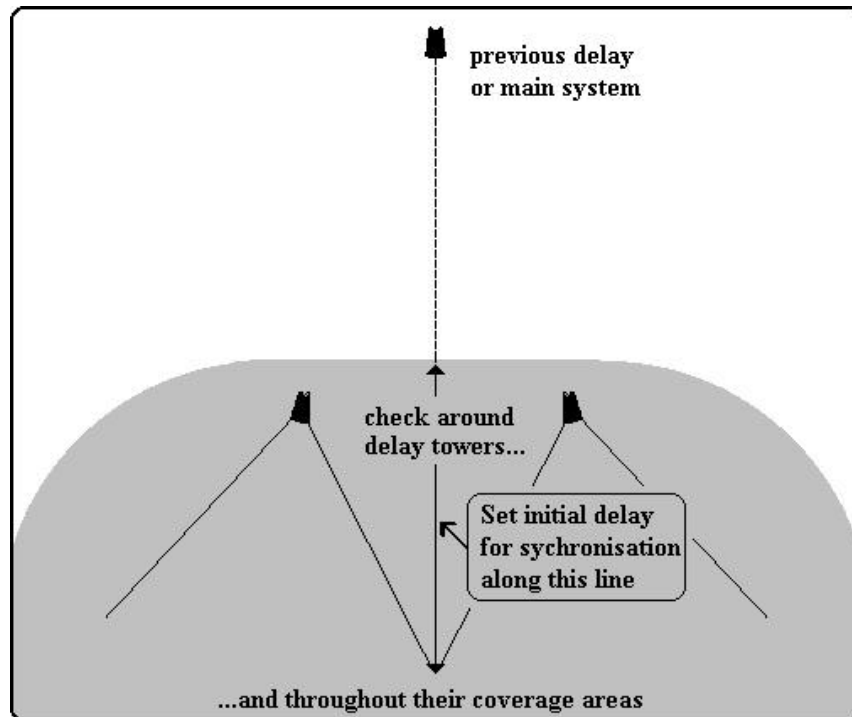

Controller delays should be adjusted, initially, for synchronisation along a line between staggered delay towers and then modified as necessary to minimise timing errors around each tower and over its main coverage area.

A1.13 Combining W8s with other Wavefront systems

The full-sized Wavefront W8 3-way loudspeaker is a member of the comprehensive Wavefront 8 family which includes:

- It's single-12" brother - the W8C 3-way system ([Section 1](#)).
- The W8CT & W8CM Longthrow line array system ([Section 2](#)).
- The W8S Hybrid™ flown subwoofer ([Section A2](#)) and its single-15" brother - the W8CS flown subwoofer ([Section 3](#)).
- The WSX folded horn subwoofer ([Section 4](#)).

Wavefront Compact W8C and W8CS systems fulfill the requirement for smaller touring components with a slight reduction of low frequency performance as follows:

Model	LF components	LF limit (-10dB)
W8	2 x 12" horn-loaded	80Hz
W8C	1 x 12" horn-loaded	100Hz
W8S	1 x 18" (ported) + 1 x 15" (horn-loaded)	30Hz
W8CS	1 x 15" (horn-loaded)	35Hz

Wavefront 8 family members can be combined successfully to make larger systems out of the available enclosures because they use similar high-mid and HF driver and horn components and compatible rigging.

Martin Audio DX1 controllers are pre-loaded with a wide range of system programmes to combine Wavefront 8 components using the correct crossover characteristics and delay settings. Experienced users may mix and match DX1s with standard crossover settings for custom combinations. See the DX1 Speaker Management System Operating Instructions (issued with the DX1) for further details.

For instance, two Wavefront users may combine their smaller systems for a larger event. If one user has W8S Hybrid™ subwoofers and the other has WSX folded-horn subwoofers, their systems would need to be set up so that the subwoofer systems combine in phase with the correct time alignment.

A quick interrogation of DX1 programmes 24 (for W8+W8S) and 21 (for W8+WSX) shows that the W8+W8S settings would need their delays increasing by 3.771mS to align with the W8+WSX settings. This is because the WSX's long folded horn gives it a longer acoustical delay than the W8S' shorter mid-bass horn.

The extra W8 delay is catered for in the DX1 set to programme 21 but not in the DX1 set to programme 24 - which is set up for the W8S.

WSX -----4.361mS-----W8 Low mid
 WSX -----3.771mS-----W8S--0.59mS--W8 Low mid

The extra 3.771mS may be added to the DX1 set to programme 24 as an input delay.

Combining Subwoofers

The following illustration shows WSX and W8S subwoofers combined for a larger event as discussed.

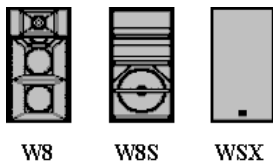

Main Audience Subs and Front-fills

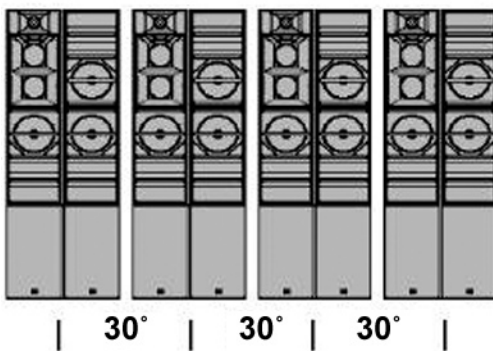

Apron WSXs and W8 Front-fills...

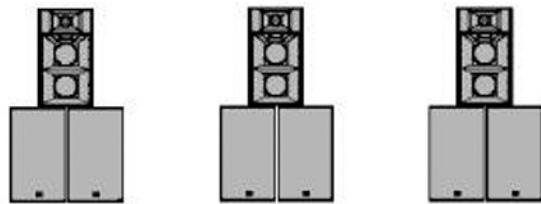

Combining Wavefront W8 and Wavefront Longthrow systems

(See next page)

The left cluster for an athletic field is shown. The main forward section includes 4 rows of Longthrow with another 2 rows of W8CTs being used to augment the outer columns.

The W8-to-W8CT vertical splay angle is kept very small (3° - just one M.A.N. flying system chain link) to provide a smooth transition between the two sections.

Wavefront Longthrow (Line Array) systems have more forward gain than regular W8 systems so amplifier gains should be set to allow for this. The W8CT/CM amplifier channels are usually attenuated by 6-9dB wrt the W8 amplifiers.

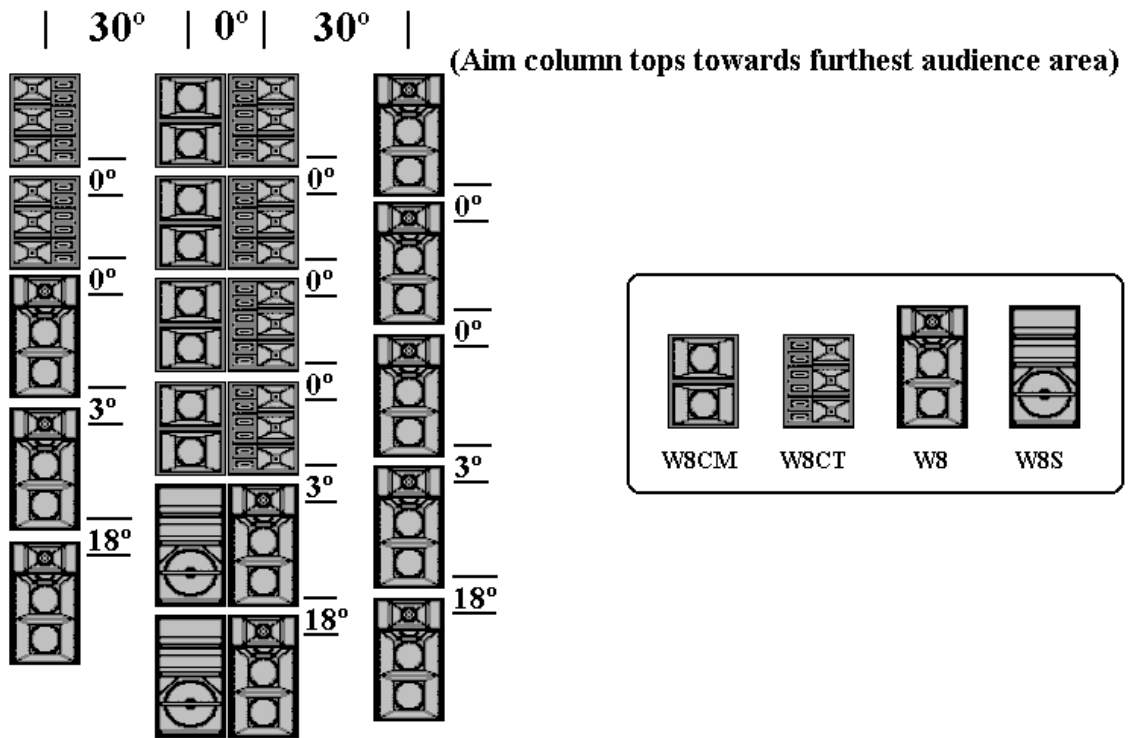

See [Section 2](#) for further Wavefront W8CT/CM information.

See [Section A2](#) for guidance on W8/W8S combinations.

Appendix 2

Wavefront W8S Hybrid™ Subwoofer

Contents

- [A2.1](#) Introduction**
- [A2.2](#) Specifications**
- [A2.3](#) Pin-outs and cabling**
- [A2.4](#) System patching**
- [A2.5](#) DX1 Loudspeaker Management System**
- [A2.6](#) Power amplifier recommendations**
 - [A2.6.1](#) Martin Audio MA4.2 Power Amplifier Overview**
- [A2.7](#) Adding W8S' to flown W8 systems**
- [A2.8](#) W8S Ground Arrays**

Wavefront W8S Hybrid™ Subwoofer



A2.1 Introduction

The Martin Audio Wavefront W8S Hybrid™ Subwoofer combines a horn-loaded 15" driver with a ported 18" high-excursion direct radiator. This powerful combination gives the W8S the characteristic punch of a horn-loaded system with the low frequency bass extension of a reflex enclosure.

The W8S is a light weight system in a trapezoidal cabinet. It has the same footprint as the W8 3-way system and has been engineered to extend the Wavefront W8's performance to below 40Hz.

Like all flown Wavefront products, the W8S is fitted with MAN load-certified flying points and is designed to comply with the 12:1 safety factor specified by the German VBG70 standard when used with compatible 12:1 flying systems. One important advantage of the MAN flying system is that inter-cabinet connections place a minimal load on the cabinets and, being external, can be load certified and inspected independently.

A2.2 Specifications

Type:	Hybrid™ bass system
Frequency response:	40-150Hz +/- 3dB
Low frequency limit:	-10dB at 30Hz
Driver:	1 x 15" (380mm) horn loaded 1 x 18" (460mm) reflex loaded

Rated Power:	800W into 8 ohms, 3200W peak
Sensitivity:	104dB/W
Maximum SPL:	131dB continuous, 137dB peak
Impedance:	8 ohms nominal per driver
Connectors:	2 x Neutrik NL8, 2 x EP8
Cabinet construction:	Birch Ply
Cabinet finish:	Slate textured paint
Protective grille:	Perforated steel
Grille finish:	Grey paint
Dimensions (inc wheels):	(W) 562mm x (H) 1066mm x (D) 925mm (W) 22.1ins x (H) 42.0ins x (D) 36.4ins
Weight:	90kg (198lb)

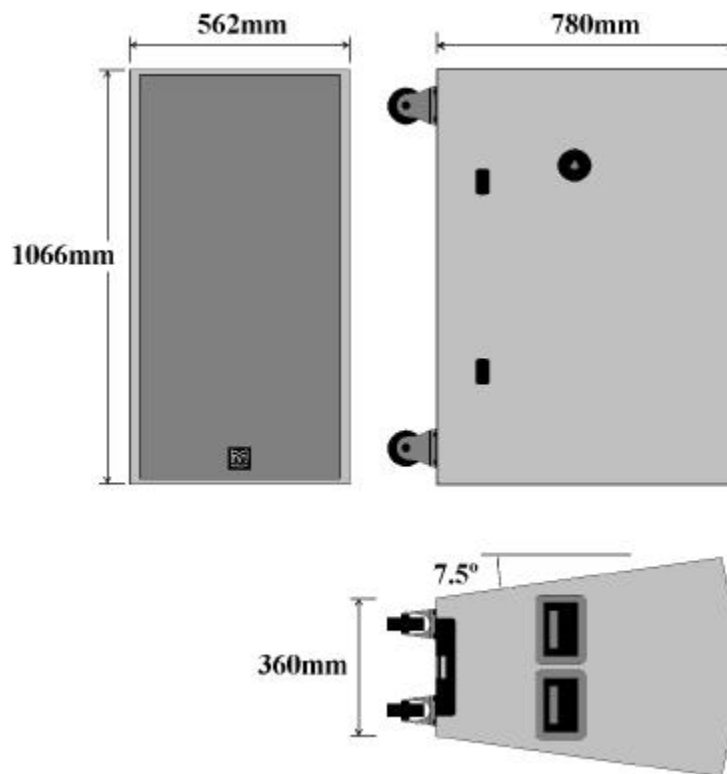

A2.3 Pin-outs and cabling

W8S		
EP8	NL8	W8S
1	-1	18" Driver -
2	+1	18" Driver +
3	-2	18" Driver -
4	+2	18" Driver +
5	-3	15" Driver -
6	+3	15" Driver +
7	-4	15" Driver -
8	+4	15" Driver +

(See [Section A1.3](#) for NL connector pin-out drawing)

A2.3.1 Cable and panel connector part numbers

Please note the following part numbers when ordering loudspeaker connectors to make up cables and patch panels:

Neutrik NL connectors	
NL8FC	8 pole cable (female)
NL8MPR	8 pole panel (male)
NL8MM	8 pole inline coupler (male-male)
Cannon EP connectors	
EP8-11	8 pin cable female
EP8-12	8 pin cable male
EP8-13	8 pin panel mount female
EP8-14	8 pin panel mount male

Connectors should be kept in good, clean, uncorroded condition to ensure full, undistorted loudspeaker performance. Corroded or damaged pins and sockets can cause severe distortion or loss of signal.

A2.3.2 Recommended loudspeaker cable



Cable run vs copper core cross sectional area

	Single W8S	Two W8S' paralleled at the cluster.
Up to 50m	2.5mm ²	6mm ² (or 2 x 2.5mm ² cores in parallel)
Up to 100m	6mm ²	10mm ² (or 2 x 6mm ² cores in parallel)

Q. Why the odd sizes?

A. Loudspeaker cables are available in a limited range of standard copper core sizes - ie. 1.5mm², 2.5mm², 4mm², 6mm², 10mm² and 35mm².

A2.4 System patching

Refer to [Section A1.4](#) for general Wavefront patching suggestions and examples.

Bass sub-mix operation

Many mix operators prefer to create a separate sub-mix for bass/mid-bass sections. This is good practice as it helps provide main system headroom for those all-important vocals and solos whilst allowing for larger-than-life percussion and bass instrument mixes without intermodulation and distortion.

This configuration can easily be programmed into the Martin Audio DX1 Loudspeaker Management System. The following illustrates a DX1 set up to control an active (3-way) Wavefront W8 system with a separate W8S sub-mix.

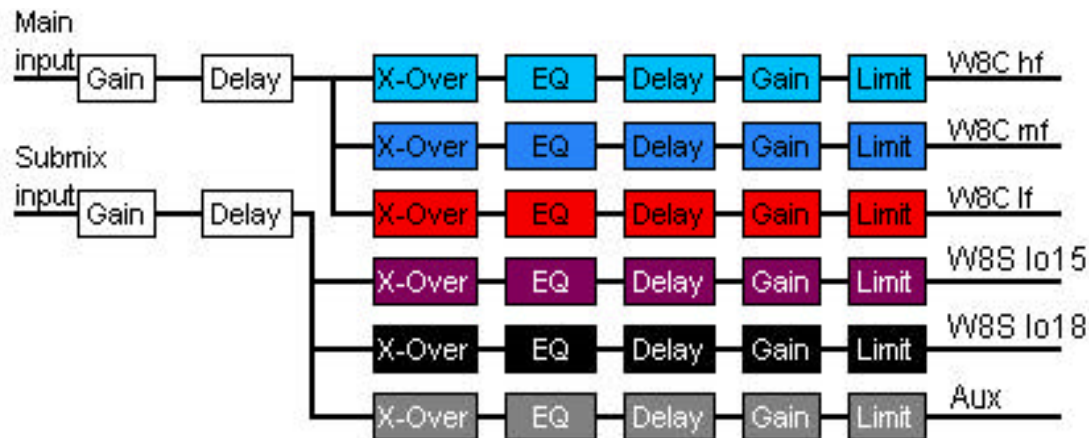

A2.5 DX1 Loudspeaker Management System

Note:

W8S systems may be driven 2-way for maximum performance. Time aligning the W8s' 18" reflex-loaded driver with its 15" horn-loaded section provides exceptional mid-bass punch and impact.

DX1 Programme 24 should be used as your default setting. (See [Section A1.5](#))

A2.5.1 DX1 Output Gain and Limiter settings for W8S'

Gain settings

The following initial DX1 output gain settings will enable full system performance to be obtained whilst keeping the console and drive system noise floors inaudible and avoiding amplifier slew-rate limiting:

W8S - assuming 800Wcont - 1600Wpk into 8Ω power amplifiers:				
Best-fit Amplifier Example	Amplifier Sensitivity dBu	Amplifier Gain Vrms dB	Initial DX1 Output <u>GAIN</u> (Lo15" & Lo18" o/ps) dB	
Crown MA5002VZ (0.775v)	-2	0.62	42	-9
Martin MA4.2** (41dB)	-1	0.69	41	-8
Crest CA18 (x115)	-1	0.69	41	-8
Crown MA3600VZ (0.775v)	-1	0.69	41	-8
	0	0.77	40	-7
	+1	0.87	39	-6
	+2	0.98	38	-5
	+3	1.09	37	-4
QSC PL236/PL236A (36dB)	+4	1.23	36	-3
	+5	1.38	35	-2
	+6	1.55	34	-1
	+7	1.73	33	0
Martin MA4.2** (32dB)	+8	1.95	32	+1
Crest 8001 (x40)	+8	1.95	32	+1
Crest 9001 (x40)	+8	1.95	32	+1
QSC PL236A (32dB)	+8	1.95	32	+1
	+9	2.18	31	+2
	+10	2.45	30	+3
	+11	2.75	29	+4
	+12	3.08	28	+5
	+13	3.46	27	+6
Crown MA3600VZ (26dB)	+14	3.88	26	+7
Crown MA5002VZ (26dB)	+14	3.88	26	+7
QSC PL236A (26dB)	+14	3.88	26	+7

** Set Martin Audio MA4.2 rear MLS switch to 0dB to match peak output of unregulated power amplifiers.

Standardising on one good model of power amplifier (preferably the [Martin Audio MA4.2](#)) and correctly set-up controller (preferably the [Martin Audio DX1](#)) will provide the most dynamic system performance and protection whilst simplifying design and reducing spares inventories. (See [Section A1.5](#) and [DX1 Speaker Management System User's Guide](#) for further details)

Cluster balance (eg farfield-to-midfield or inner-to-outer) should be adjusted **at the power amplifier controls** to maintain limiter tracking. See [Section A2.7](#).

Balancing the system using gain controls in the signal path *before* the power amplifiers is not recommended as it will cause the higher signal level upper rows of a big cluster to start limiting before the lower signal levels downfills resulting in tonal changes at the mix position.

Limiter settings

The Rated Power specification in [Section A2.2](#) indicates the maximum long-term power dissipation that can be tolerated before driver ageing or damage occurs through overheating or over-excursion.

When choosing power amplifiers, do not be tempted to exceed the 800W into 8Ω power rating unless the amplifier's power rails are well regulated (see [Section A2.6](#)) - even with properly set controllers in place. Although Martin Audio drivers are mechanically designed to survive normal road use and the occasional operator error, overpowered or bridged amplifiers can cause over-excursions that stress and age drivers. The best way to get the clean, relaxed sound of an overpowered amplifier is to choose an amplifier with plenty of current reserve - ie an amplifier with good 2Ω specification - and avoid running more than two cabinets in parallel.

To ensure transparent limiter operation without obvious distortion or pumping, the DX1 limiter attack and release times are factory preset to be inversely proportional to the subwoofer's high pass frequency as follows:

High pass filter range	Attack time	Release time
>31Hz	45mS	720mS
31Hz - 63Hz	16mS	256mS

These attack times allow the power amplifiers to clip momentarily but not for long enough to be obvious to listeners or cause driver overheating. It is quite normal to see amplifier clip indicators on the odd programme peak but continuous clipping would indicate a cable short circuit, wrong controller settings, excessive power amplifier gain or low mains voltage.

The following initial DX1 output limiter settings will avoid voice coil overheating and minimise amplifier clipping for high quality, trouble free operation.

W8S - assuming 800Wcont - 1600Wpk into 8Ω power amplifiers:				
Best-fit Amplifier Example	Amplifier Sensitivity		Amplifier Gain	Recommended DX1 <u>LIMITER</u> Settings (Lo15" & Lo18" o/ps) dBu
	dBu	Vrms	dB	
Crown MA5002VZ (0.775v)	-2	0.62	42	-3
<u>Martin MA4.2** (41dB)</u>	-1	0.69	41	-2
Crest CA18 (x115)	-1	0.69	41	-2
Crown MA3600VZ (0.775v)	-1	0.69	41	-2
	0	0.77	40	-1
	+1	0.87	39	0
	+2	0.98	38	+1
	+3	1.09	37	+2
QSC PL236/PL236A (36dB)	+4	1.23	36	+3
	+5	1.38	35	+4
	+6	1.55	34	+5
	+7	1.73	33	+6
<u>Martin MA4.2** (32dB)</u>	+8	1.95	32	+7
Crest 8001 (x40)	+8	1.95	32	+7
Crest 9001 (x40)	+8	1.95	32	+7
QSC PL236A (32dB)	+8	1.95	32	+7
	+9	2.18	31	+8
	+10	2.45	30	+9
	+11	2.75	29	+10
	+12	3.08	28	+11
	+13	3.46	27	+12
Crown MA3600VZ (26dB)	+14	3.88	26	+13
Crown MA5002VZ (26dB)	+14	3.88	26	+13
QSC PL236A (26dB)	+14	3.88	26	+13

** Set Martin Audio MA4.2 rear MLS switch to 0dB to match peak output of unregulated power amplifiers.



Use lower limiter settings (or more subwoofers!) if your power amplifiers indicate clipping on more than just the odd peak. Excessive clipping may also be caused by inadequate power amplifier reserve or an inadequate mains supply. See below.

A2.6 Power amplifier recommendations

The Wavefront W8S Subwoofer has been designed and manufactured for very high performance but will not give that performance unless power amplifiers are chosen and used intelligently.

Power capability

W8S' provide full performance when driven by professional power amplifiers capable of delivering undistorted output power into a range of loads as follows:

W8S

800 W(AES) into 8 ohms
1,600 W(AES) into 4 ohms
and
3,200 W(AES) into 2 ohms

Please note:

Amplifiers with excessive output may damage voice-coils or age driver suspensions due to excessive heat dissipation and excursion.

A note about power amplifier output specifications

Most power amplifier manufacturers keep their costs down by using unregulated supply rails which sag under load. To allow for this sag, manufacturers set their rails high so that they still meet their quoted output into specified loads. These high rail voltages allow such power amplifiers to provide outputs 1.5 - 2 times their quoted power for short-term bursts. Martin Audio products will withstand this potential doubling of instantaneous power - [*with suitably set controller limiters*](#) - but further, long-term increases caused by over-sized amplifiers should be avoided.

Martin Audio MA series power amplifiers have regulated rails so it is quite permissible to use slightly overpowered models - [*with suitably set controller limiters*](#) - without risking uncontrolled power bursts. The MA series power amplifiers' regulated power rails also ensure maximum performance under the real-world concert conditions of less-than-optimum mains supplies and low impedance loads.
[See Section A2.6.1](#) for further details.

Amplifier load tolerance

An efficient subwoofer system in live concert conditions can act as a surprisingly

dynamic and complex load. Most modern touring power amplifiers claim 2 ohm capabilities but make sure your amplifier is also capable of driving reactive (ie inductive or capacitive) loads without prematurely clipping or developing output stage crossover distortion.

Power reserve

Most power amplifier specifications are based on bench measurements made using stable, high current mains supplies and well defined loads. Amplifiers sound best when they have plenty of current in reserve for percussive peaks and sustained bass notes.

- 1) Try to ensure that the mains supply stays within the amplifier manufacturer's specified range from no load to maximum load.

An electrical technician should check the mains supply vs demand using an accurate rms voltage meter.
- 2) If unfamiliar generators are being used the electrical technician should check the mains waveform (using a portable 'scope-meter) to make sure that it is sinusoidal and not crawling with spikes or interference.
- 3) Avoid driving too many W8S drivers in parallel. I would suggest no more than 2 x 15" or 2 x 18" per amplifier channel so that the power amplifier's 2 ohm spec is kept in reserve for musical peaks.
- 4) Avoid using power amplifiers in bridged mode. Most commercial power amplifiers are optimised for 2-channel operation. It is usually better to use the appropriate amplifier in 2-channel mode than to use an inadequate amplifier in bridged mode.

Note that W8S 15" and 18" drivers may be driven in parallel - i.e. in passive mode (DX1 programmes 22 or 23) to save amplifier channels on smaller systems ... but with reduced punch and slam.

W8S' should always be driven actively (DX1 programme 24) when power amplifier budgets allow.

Power amplifier gain or level settings reminder

Gain switches

If you are lucky enough to have amplifiers with user gain switches, set them all to identical positions. A voltage gain in the range 23-33dB will provide a good balance of system headroom and noise (assuming professional audio equipment is in use FOH).

Level controls

The front panel level controls should be turned down (fully counter clockwise) until FOH-to-Amp rack lines have been checked and controllers have been set to suit the power amplifiers to be used (see [Section A2.5.1](#)). Music should be used to check that controllers are receiving and sending the appropriate signal bands and then each power amplifier level control advanced in sequence to check system operation and patching.

Assuming that controllers have been set as tabulated in [Section A2.5.1](#), power amplifier level controls should be set to full (fully clockwise) for loudspeaker sections requiring the strongest drive. Amplifiers driving nearer-field section within the same cluster may be backed off as required for smooth coverage. This process will ensure that the cluster coverage remains balanced during limiting.

Rack mounting

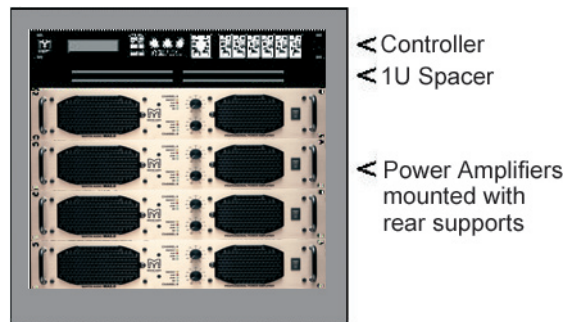

As with main W8 systems, always leave a 1U space between big subwoofer power amplifiers and controllers. Although most modern amplifiers don't radiate significant fields it's better to play safe and keep the system free from hum & buzz. Rear supports are recommended. Check the manufacturer's application notes for details.

A2.6.1 Martin Audio MA4.2 Overview



Features

- Switch mode power supply
- Superior sonic performance
- Light weight
- Advanced protection circuits
- Efficient copper cooling system
- Minimum load switches (MLS™)

The MA4.2 power amplifier has been designed to combine reliability and high power output with sonic excellence. Utilising an advanced switch mode power supply, the MA4.2 is characterised by a very high power-to-weight ratio, in a lightweight, 2U package.

See [MA4.2 Amplifier User's Guide](#) for detailed operating instruction.

Cooling System

The Martin Audio MA4.2 amplifier runs very cool due to a special patented copper cooling system. The amplifier's bi-polar output devices are mounted directly onto a copper heat sink (copper conducts heat twice as efficiently as aluminium) and maximum heat dissipation is achieved by turbulent airflow over the heatsink's geometric fins.

The MA4.2 amplifier features two proportional speed cooling fans which take in air from the front of the amplifier and exhaust from the rear. A horizontal pressure chamber between the heatsink and the cooling fans ensures that there is little difference in the operating temperatures of each output device. In contrast, a conventional tunnel design can result in a temperature variance of up to 40° between output devices.

Switch Mode Power Supply

The MA4.2's switch mode power supply (SMPS) is the modern solution to the problems of size and weight. Switch mode power supplies are not new - they are found in computers and televisions. However, the demands of high power audio are very different to these applications. The MA4.2 overcomes the size and weight constraints of conventional power supplies whilst at the same time avoiding the pitfalls of typical switch mode designs.

The low output impedance of the SMPS means that rail voltages do not sag under heavy load conditions. Additionally, the rail capacitors are being recharged at a much faster rate than those in a conventional power supply. The result is an exceptional fast transient low frequency performance at all power levels.

Efficiency is also maximised. With much smaller transformers than a conventional supply, there is much less loss due to transformer resistance and much less power wasted as heat in the power supply.

Regulation of the SMPS means that the power amplifier will produce the same power output, even if the AC line voltage drops by 20%.

Minimum Load Switches (MLS™)

Because the SMPS is regulated, the maximum power available for the output stages can be adjusted without increased heat dissipation or efficiency loss. This allows the user to match the output power with the loudspeaker impedance.

Protection

The MA4.2 amplifier has many advanced protection features that will protect both the amplifier and the speakers connected to it, under fault conditions. All protection circuits are independent and inaudible in normal use.

Clip Limiters

Clip limiters prevent dangerous clipped signals reaching the speaker. They work by monitoring the output to check for signals not present at the input i.e. distortion. If distortion exceeds 1% on an output, the limiter will reduce the input signal proportionally.

Thermal Protection

Thermal Protection circuitry prevents the amplifier from running at an unsafe temperature by muting the input signal when the internal temperature rises above 90°C.

Short Circuit Protection

The MA4.2 amplifier is completely short circuit protected. The protection circuits permit very high peak currents, but maintain the output devices within their safe operating area.

Mains Voltage Protection

This operates if the mains voltage falls outside its permitted operating range. If this occurs, the power supply will shut down until the correct mains voltage is restored.

DC and VHF Protection

Both DC voltages and high power VHF signals can cause damage to loudspeakers. The MA4.2 amplifier incorporates protection circuits which are activated when damaging DC voltages or VHF signals are present at the outputs.

MA4.2 Specifications

Input Impedance	20kohms (balanced) 10kohms single ended
Gain select switch	41dB (I/P sens 0.775V), 32dB (I/P sens 2.26V)
CMRR at 1KHz	>50dB
Output impedance at 1KHz	<0.06 ohms
Power Bandwidth	5Hz - 20kHz
Slew rate	20V/us
Hum/Noise	<-95dB
Channel Separation	1kHz > 80dB 10kHz > 70dB
Mains Operating Voltage	120 – 270 (minimum start voltage 190) full output power maintained 180 – 280V Optional (65 - 135V) operation.
Protection	DC, High temperature, Turn on, VHF, Over and under voltage, Clip limiters AFS Short circuit
Distortion	
THD 20Hz - 20kHz and 1W – 1000W	4 ohms 0.1% 4 ohms 0.04%
THD at 1 kHz and 2000W	4 ohms 0.04%
DIM 30 at 500W	4 ohms 0.04%
CCIF (13 and 14kHz) at 500W	4 ohms 0.04%
SMPTE (60Hz and 7kHz) at 500W	

Power Matrix

LOAD CONFIGURATION	MLS SWITCH SETTING			
	(-5dB)	(-4dB)	(-2dB)	(0dB)
16 ohms Stereo (2 channel)	220W	260W	410W	650W
8 ohms Stereo (2 channel)	430W	520W	820W	1300W
4 ohms Stereo (2 channel)	830W	1000W	1600W	2100W
2 ohms Stereo (2 channel)	1660W	2000W	2200W	2400W[1]
			3050W[2]	3200W[2]
16 ohms Bridged mono	860W	1040W	1640W	2600W
8 ohms Bridged mono	1660W	2000W	3200W	4200W
4 ohms Bridged mono	3320W	4000W	4400W	4800W[1]

[1] = Component tolerance dependent
[2] = Continuous power, one channel driven or peak power both channels driven. Thermal protection may occur at high

continuous power. Power in watts
(EIA 1kHz, 1% THD)

Weight	10kg (22lbs)
Dimensions	(W) 483mm x (H) 88mm x (D) 347mm (W) 19ins x (H) 3.5ins x (D) 13.7ins

A2.7 Adding W8S' to flown W8 systems

Although the Wavefront W8S is often used as a base for smaller floor-stacked or stage-stacked systems, flying W8S' with main W8 systems can keep the floor tidy and free up floor space for scenery, TV camera tracks etc.

As mentioned earlier, very large outdoor festival crowds will absorb mid-bass from low-profile, ground stacked subwoofers. Flying W8S' will provide a tight, efficient and detailed bass performance without audience mid-bass absorption.

A2.7.1 W8S/W8 configurations

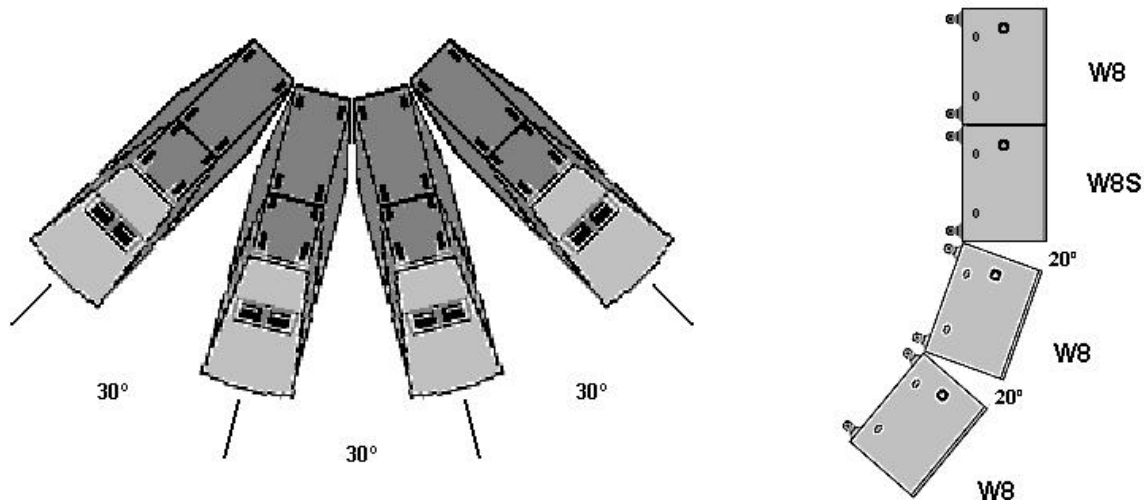

For medium power applications - amplifying a large orchestra, for example, where low frequency stability is important - a single row of W8S' may be added to a standard W8 cluster extending its low frequency response to below 40Hz. This configuration can be very efficient as it uses the rest of the cluster as a baffle, increasing forward projection allowing high gain before feedback.

The following iconic layout may be used to represent the above cluster:

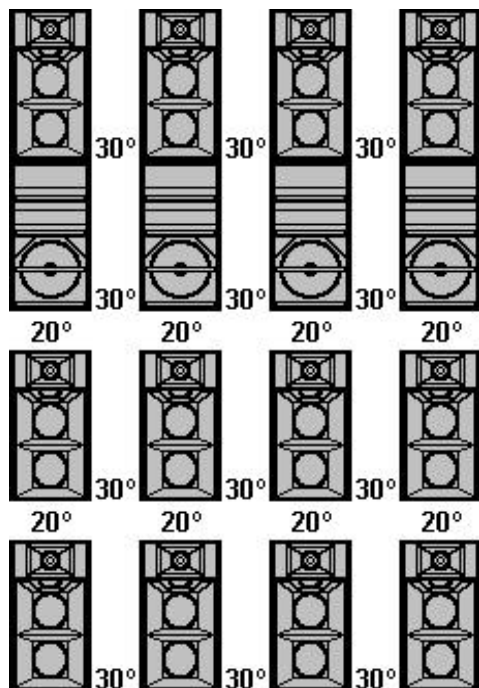

Important reminder:

Splay angles are always quoted axis-to-axis - not between cabinet sides!

ie.

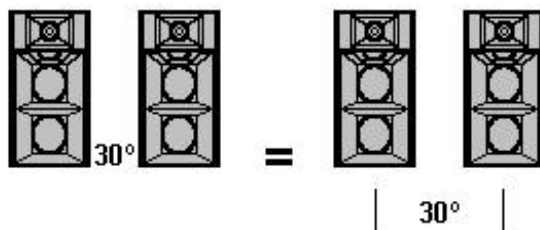

Multiple rows of W8S'

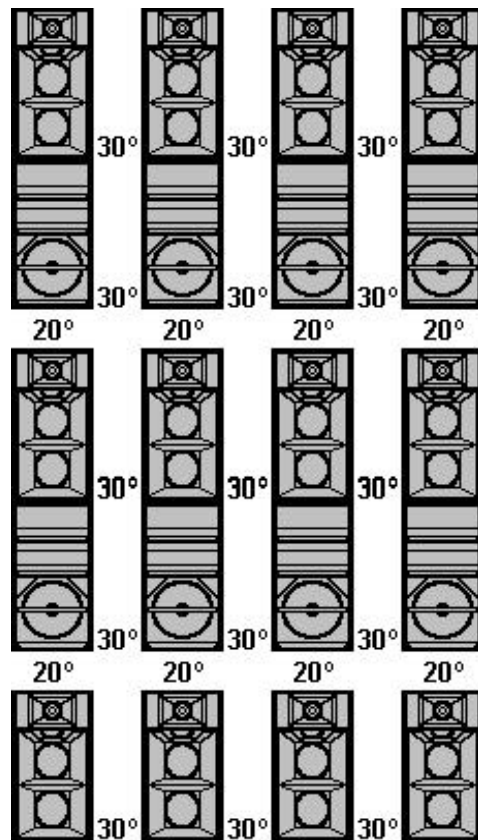

Multiple rows of W8S' increase low frequency headroom for higher power rock, dance club applications. Flying W8S' in rows keeps clusters relatively narrow where width is at a premium.

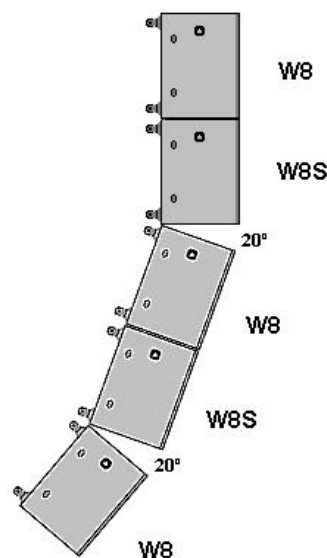

Coverage would be 145° horizontal x 70° vertical.

For *very* high power rock or dance applications, the above W8S' may be configured as flown mid-bass elements (crossed in at 80Hz and out at 150Hz) to augment floor-stacked WSX folded-horn subwoofers working as low subs below 80Hz. Refer to [Section 4](#) for further information on WSX folded-horn subwoofers.

Power amplifier monitoring at real-world gigs have shown that half of the total system power is demanded between 60Hz & 160Hz during heavy rock and dance music.

W8S' flown in columns with W8s

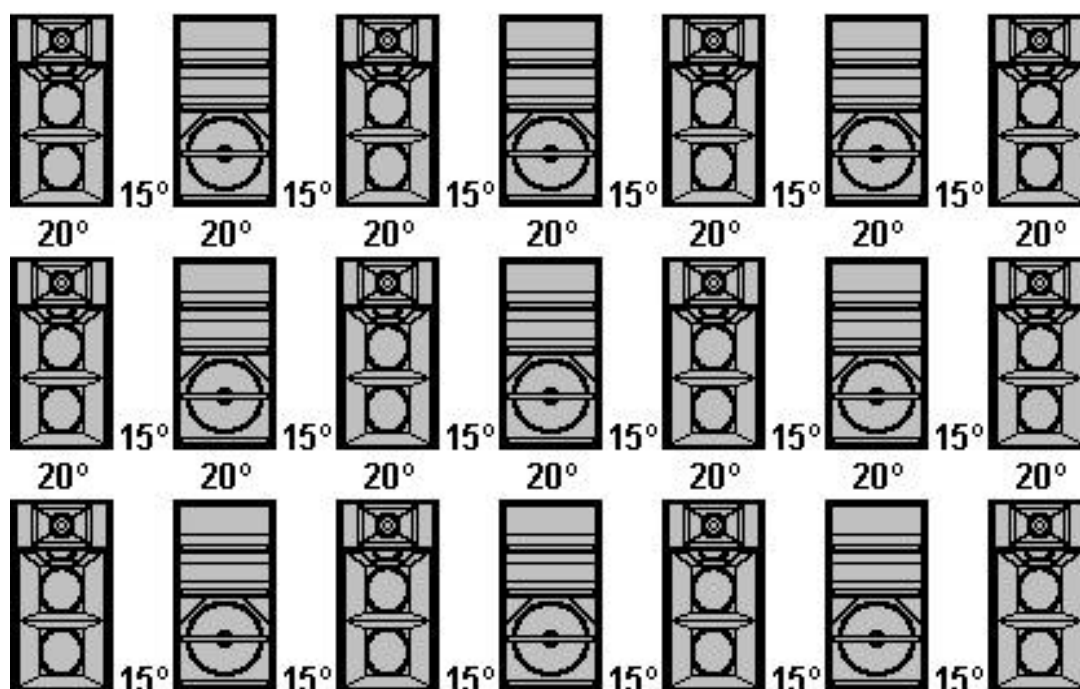

Flying W8S' in columns between W8 columns keeps clusters shorter whilst providing good vertical control for minimum roof excitation.

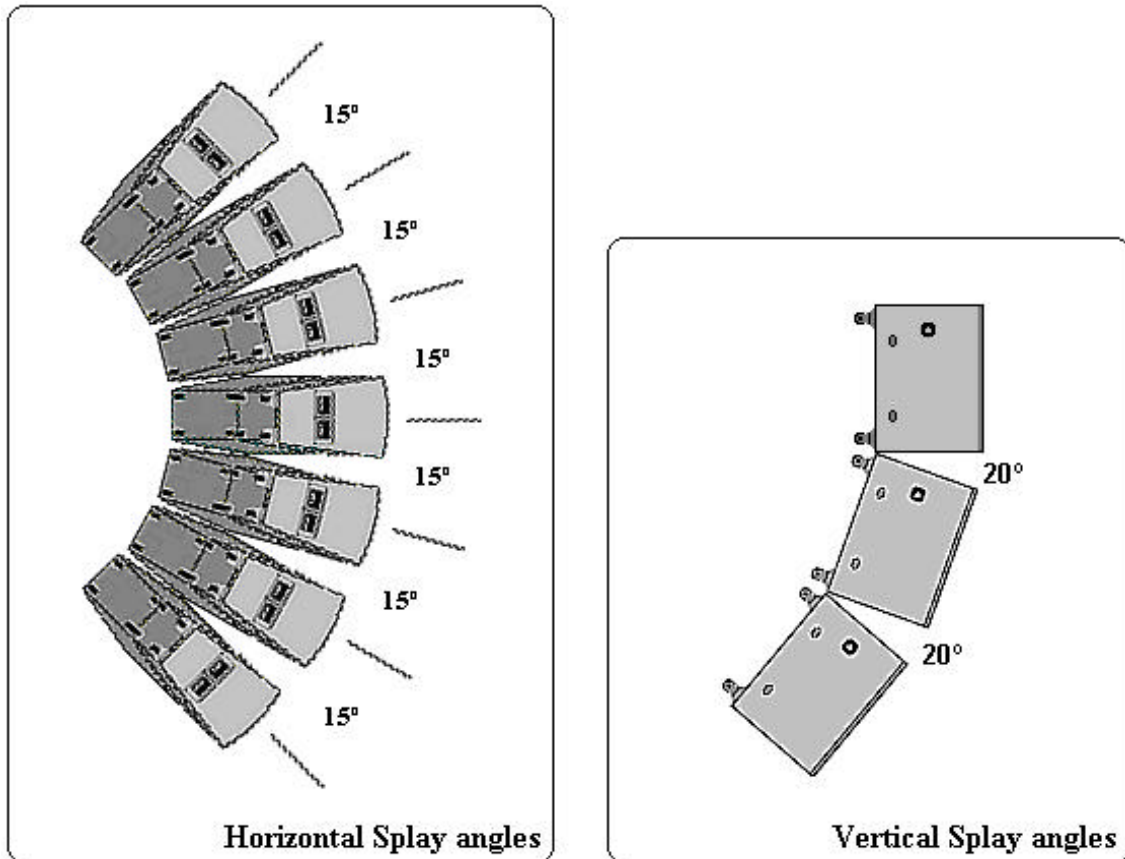

Again, coverage would be 145° Horizontal x 70° Vertical.

A2.8 W8S Ground Arrays

W8S Hybrid™ subwoofers provide maximum coherence when flown with the main system but may be arrayed on the ground if flying weights are restricted or the ground's boundary effects are required to maximise system headroom.

Stacking safety!

Stacked W8S' should always be blocked, strapped and anchored from above by a qualified rigger.

Coverage angle for tightly packed flat fronted arrays

-6dB Coverage

Here is a simplified formula for calculating the main coverage angle of a tightly packed flat fronted array.

$$\text{Main coverage angle (between -6dB points either side of axis)} = 2 \times \arcsin \left(\frac{0.61\lambda}{Nd} \right)$$

where λ = the sound wavelength in meters = $\frac{340^*}{\text{Frequency (Hz)}}$
 N = the number of subwoofers
 d = the centre-to-centre spacing
 (d = the subwoofer width or height if tightly packed)

* = approximate speed of sound in m/s. Varies with temperature (see [Section 2a](#)).

Arcsin means “the angle whose sin is ...”

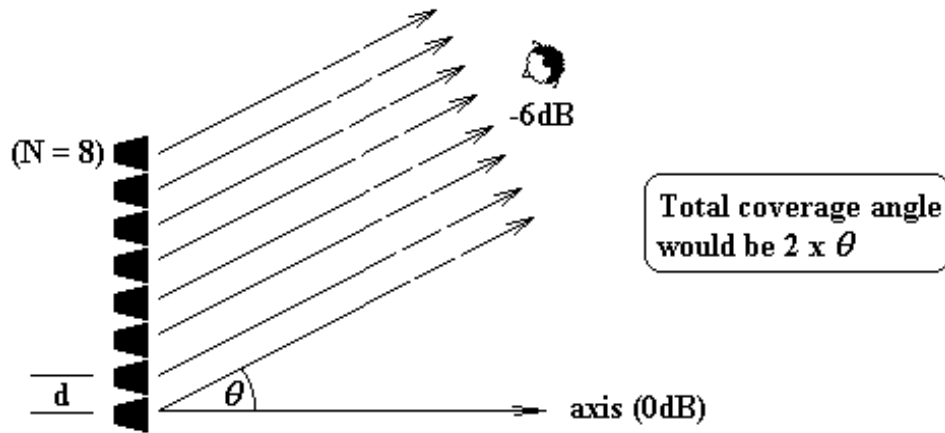

Flat fronted cluster coverage patterns will be confined to one main lobe whose mid-bass crossover directivity is proportional to the size of the cluster.

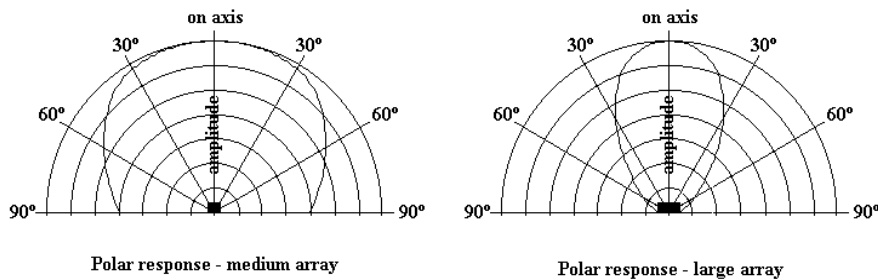

The medium sized array (left) has significant output to $\pm 90^\circ$ whereas the large array's $\pm 90^\circ$ output is dramatically reduced.

A note on coverage nulls

It is useful to be able to calculate where these first response nulls will occur for various frequencies as they indicate areas where coverage, transient response and directional information would be poor without fill systems. For symmetrical arrays nulls will occur either side of the on-axis line. We can calculate the overall “null-to-null” angle using the simple formula:

$$\text{Null-to-null angle} = 2 \arcsin \left(\frac{\lambda}{Nd} \right)$$

As a very rough guide, the null-to-null angle will be approximately twice the -6dB coverage angle.

Interpreting polar plots

i) It is conventional to “normalise” polar plot on-axis amplitudes so that different polar shapes may be readily compared. In practice, the large array (right example) would have a higher on-axis amplitude than the medium array.

ii) It is also conventional to plot polar amplitudes on a logarithmic scale. This is fine when working in sound pressure level terms but is not suitable for superimposing a polar plot onto a venue plan. Venue plans are drawn to a linear scale so polar plots with linear amplitude scales would be more suitable.

iii) Polar plots have been simplified in this article for clarity. Real-world off-axis lobe amplitudes and shapes would vary considerably depending on boundary loading, echoes, reverberation and other audio sources affecting the same space.

Vertical -6dB coverage

The following table gives the approximate vertical coverage angles of typical W8S arrays - ignoring boundary effects (see later).

W8S' High (standing upright)	Vertical coverage		
	40Hz	80Hz	160Hz
2	Wide	Wide	80°
3	Wide	Wide	53°
4	Wide	80°	40°

- ◆ **Use tall stacks for long shots. Useful for long distances in low-roofed venues with raked seating up to the height of the stack.**
(Important: see safety note above)
- ◆ **Use short stacks for short, wide vertical shots.**

Vertical Boundary effects

A solid floor will act as a reflector. This will cause a vertical stack to perform as if it were double the length, giving a useful low frequency boost accompanied by a narrower, more complex polar response.

For instance, a 4 high ground-stack of W8S' will act like the top half of an 8 high stack. *(Important: see safety note above)*

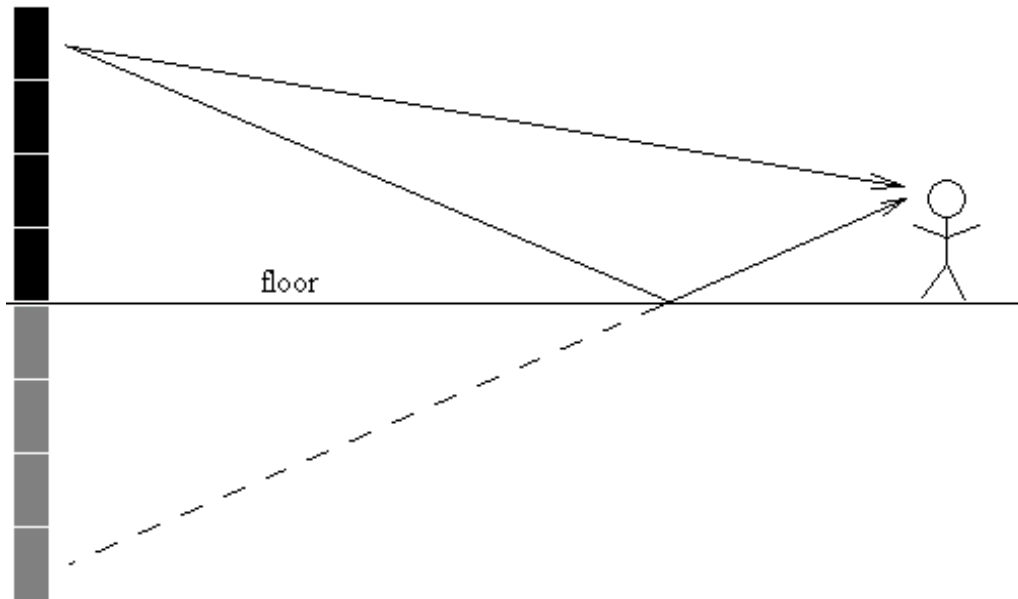

Note that flexible floors may actually absorb sound at some frequencies so the situation isn't always so simple in practice.

Horizontal - 6dB coverage

The following table gives the approximate horizontal coverage angles of typical W8S arrays - ignoring boundary effects.

W8S' Wide (standing upright)	Horizontal coverage		
	40Hz	80Hz	160Hz
3	Wide	Wide	98°
4	Wide	Wide	69°
8	Wide	69°	33°
16	69°	33°	16°

With W8S' standing upright, flat fronted cluster coverage patterns will be confined to one main lobe whose mid-bass crossover width is inversely proportional to the size of the cluster as long as horizontal gaps are less than 500mm.

- ◆ *Use wide arrays for long shots. Useful for long, narrow venues*
- ◆ *Use narrow arrays for short, wide shots*

Horizontal Boundary effects

A solid wall near an array will act as a reflector. This will cause a horizontal array to perform as if it were twice as wide, giving a useful low frequency boost accompanied by a narrower, more complex polar response.

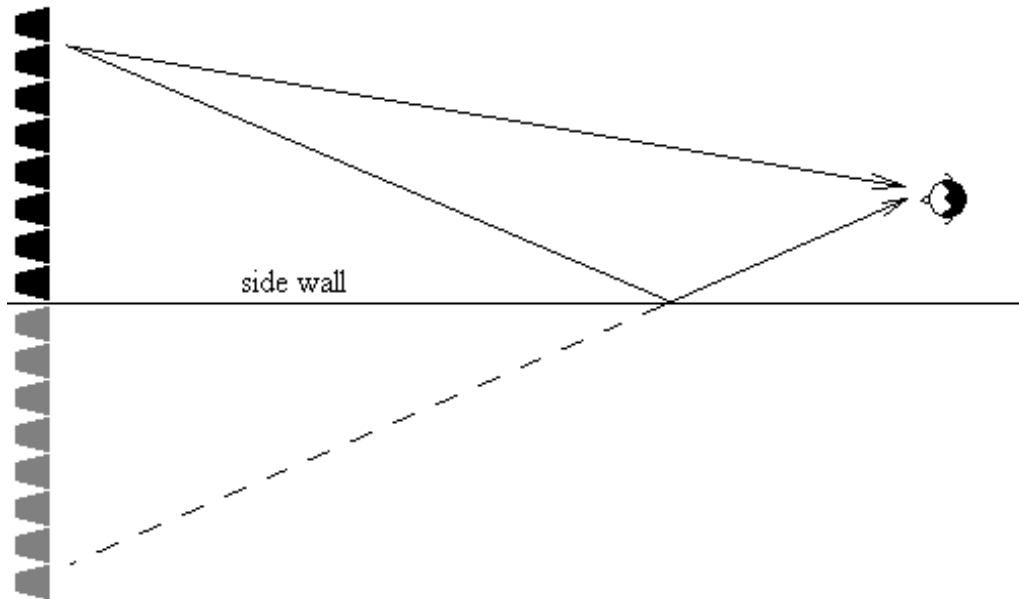

Again, a flexible side wall may absorb sound at certain low frequencies. Boundaries should always be treated with caution.

Spacing

It is possible to space out W8S' to provide a larger frontal area with fewer units but care must be taken to avoid irregular coverage at higher, mid-bass frequencies.

The following formula gives the pressure ratio (wrt the on-axis pressure) for any off-axis angle of a regularly spaced linear array:

$$p(\theta) = N \frac{\sin[(N\omega d/2c) \sin \theta]}{N \sin[(\omega d/2c) \sin \theta]}$$

- where N = the number of subwoofers
- d = the centre-to-centre spacing
- c = the speed of sound = 340m/s*
- θ = the angle (wrt the axis)
- $\omega = 2\pi f$

* varies with temperature

Far field polar patterns can be quite complicated - even for a simple pair of subwoofers driven in unison.

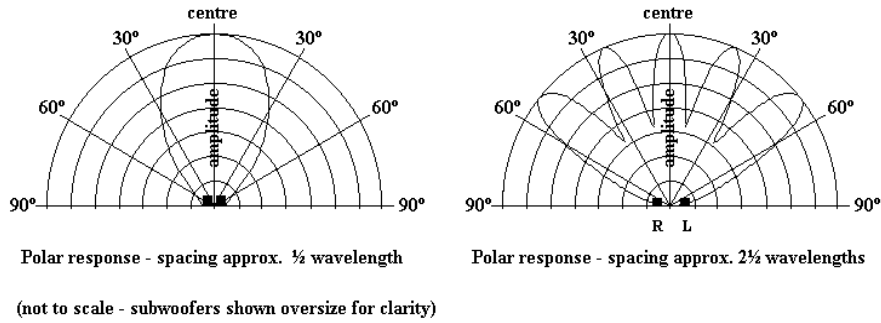

Wide spacing will cause off axis irregularities (combing) because time offsets start to become significant. See [Section 4.10](#) for a more detailed explanation.

- ◆ *An odd number of half wavelengths will cause nulls along the line of the loudspeakers (the 90° lines) - see the 2½ wavelength example above*
- ◆ *An even number of half wavelengths will cause lobes along the line of the loudspeakers - see the 2 wavelength example below*

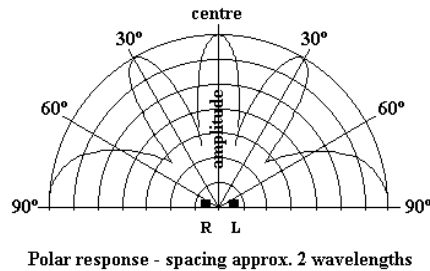

The following tables give the maximum recommended gap (between W8S sides) for the relevant frequency range.

W8S' standing upright

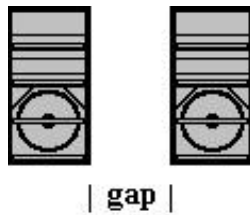

Gap	Smooth coverage range
0.5m	38 - 160Hz
1.0m	38 - 110Hz
2.0m	38 - 80Hz

To avoid mid-bass combing keep horizontal gaps below 500mm for upright W8S'

Horizontal splays

Splaying W8S' arrays horizontally will widen their mid-bass coverage.

The following sketch shows a very high power, tightly packed 8-wide x 3 high W8S ground array - splayed for smooth mid-bass coverage.

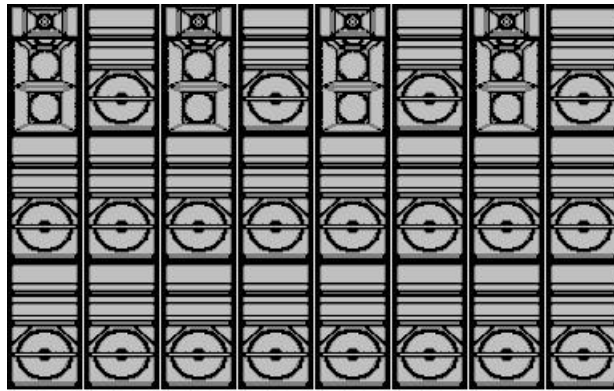
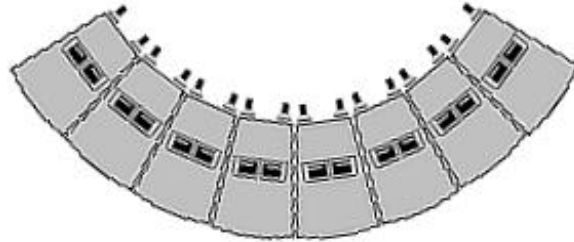

Note the four W8 front fills included in the stack. These alternate with the top row of W8S' to give the W8 front fills their nominal 30° axis-to-axis splay.

W8S' are normally used upright with the 18" unit at the bottom. This ensures that the side rigging points are nearest the top for safe rigging. Straps and rigging systems should be used to prevent ground stacks from falling over under the influence of high winds or over-exuberant fans.

For a smooth polar crossover:

- ◆ *Array the W8S' to match the curvature of the main clusters' bottom section whenever possible but avoid making the front horizontal gaps greater than 500mm.*
- ◆ *Avoid large gaps between the main system and the ground array whenever possible.*

W8S Apron Fills

To avoid irregular subwoofer coverage due to widely-spaced left-right systems, it is wise to place equally spaced W8S subwoofers along the stage apron between the main left and right ground stacks.

This practice improves low frequency consistency - particularly at and around the typical central auditorium mix position.

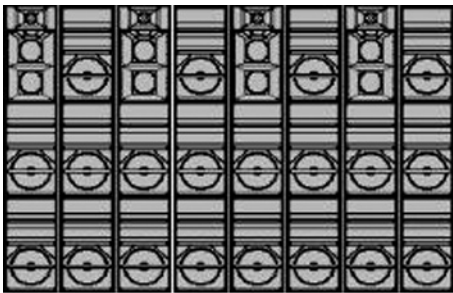

W8S Apron subwoofers W8 front fills...

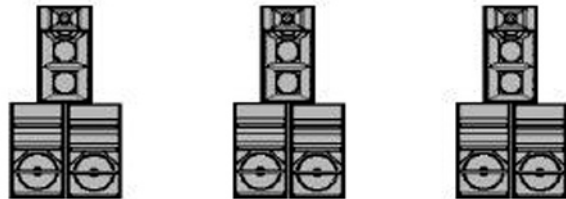

Note that W8S subwoofers may be used with other members of the Wavefront family of products including the WSX folded-horn subwoofer. See [Section A1.13](#).

(For detailed info on other Wavefront Series ground-stacks see [Section 4.8](#))